

Winter Edition

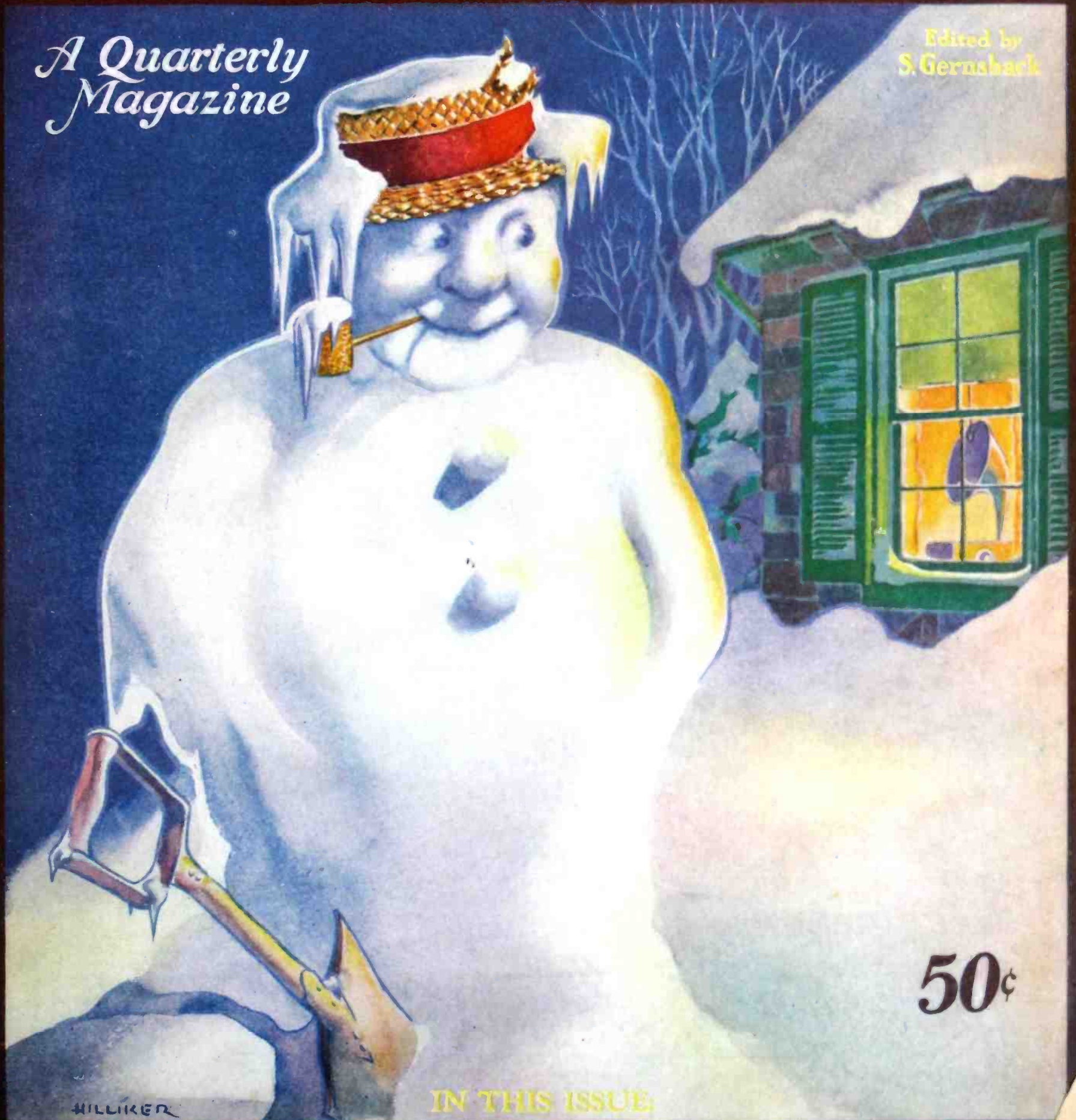
1929

# Radio Listeners' Guide and Call Book

*B Power for Res. Coupl. Audio.*

*A Quarterly Magazine*

Edited by  
S. Gernsback



HILLIKER

50¢

IN THIS ISSUE:

The Business of Selling Custom-Built Sets; Building a Corner Cabinet for the Radio Set; The Radio Set Market.

# TOBE



TOBE Tobe Type 250 B-Block



TOBE TOBE A-Filter



TOBE B BLOCKS—Model 760

A manufacturer can have no greater faith in his products than to guarantee their faithful operation and with such guarantee TOBE products are sold.



TOBE

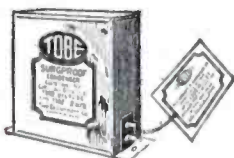
Radio Interference Filter No. 1



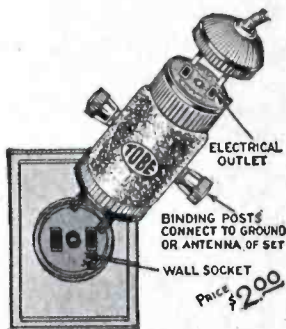
TOBE VACUUM TIPON LEAKS



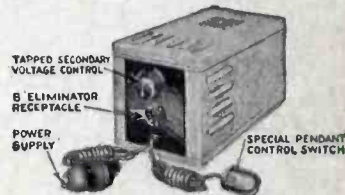
TOBE 5 WATT VERITAS FITS ALL STANDARD MOUNTS



TOBE TOBE 1300 Line Hi-Voltage SURGPROOF Condensers



TOBE 4-PURPOSE LIGHT SOCKET AERIAL



TOBE The New Tobe A Supply



TOBE TOBE A-Condenser

Write for copy of new TOBE Monthly House Organ "FILTERETTE". A complete study of interference problems of every sort and how to eliminate them.



TOBE 1000 Volt & 2000 Volt Transmitting Condenser



TOBE TINYTOBE Condensers



TOBE FILTER CONDENSERS



TOBE TOBE By-Pass Filter Condenser New Model

## TOBE DEUTSCHMANN CO.

### CANTON, MASS.

NEW YORK

CANTON, MASS.

CHICAGO

**Read what BIG money these fellows have made in the RADIO BUSINESS**

**\$375 One Month Spare Time**



"Recently I made \$375 in one month in my spare time installing, servicing, selling Radio sets. And, not so long ago, I earned enough in one week to pay for my course."  
**EARLE CUMMINGS,**  
 18 Webster St., Haverhill, Mass.

**\$1597 In Five Months**



"The N. R. I. is the best Radio school in the U. S. A. I have made \$1597 in five months. I shall always tell my friends that I owe my success to you."  
**HENRY J. NICKS, JR.,**  
 302 Safford Ave.,  
 Tarpon Springs, Fla.

**\$1164 Spare Time Profits**

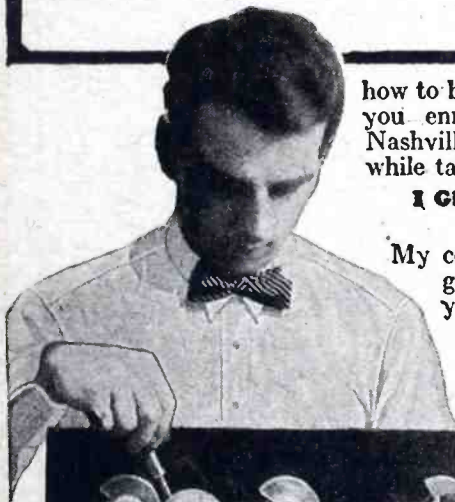


"Look at what I have made since I enrolled, \$1,164—money I would not have had otherwise. I am certainly glad I took up Radio with N. R. I. I am more than satisfied."  
**HENRY R. HEIKKINEN,**  
 123 W. Erie St., Chicago, Ill

**Over \$1000 In Four Months**



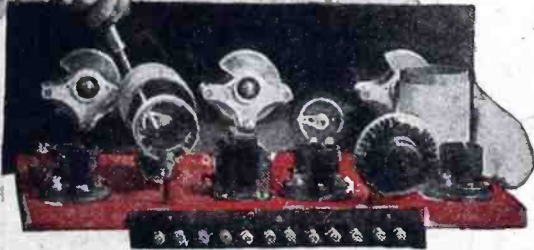
"My opinion of the N. R. I. course is that it is the best to be had at any price. When I enrolled I didn't know a condenser from a transformer, but from December to April I made well over \$1000 and I only worked in the mornings."  
**AL. JOHNSON,**  
 1409 Shelby St., Sandusky, Ohio.



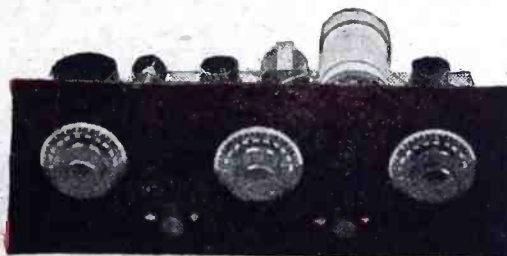
how to begin making extra money shortly after you enroll. G. W. Page, 1807-21st Ave., S., Nashville, Tenn., made \$935 in his spare time while taking my course.

**I Give You Practical Radio Experience With My Course**

My course is not just theory. My method gives you practical Radio experience—you learn the "how" and "why" of practically every type of Radio set made. This gives you confidence to tackle any Radio problems and shows up in your pay envelope too.



You can build 100 circuits with the Six Big Outfits of Radio parts I give you. The pictures here show only three of them. My book explains my method of giving practical training at home. Get your copy!



**I will show you too how to start a spare time or full time Radio Business of Your Own without capital**



Radio's amazing growth is making many big jobs. The worldwide use of receiving sets and the lack of trained men to sell, install and service them has opened many splendid chances for spare time and full time businesses.

Ever so often a new business is started in this country. We have seen how the growth of the automobile industry, electricity and others made men rich. Now Radio is doing the same thing. Its growth has already made many men rich and will make more wealthy in the future. Surely you are not going to pass up this wonderful chance for success.

**More Trained Radio Men Needed**

A famous Radio expert says there are four good jobs for every man trained to hold them. Radio has grown so fast that it simply has not got the number of trained men it needs. Every year there are hundreds of fine jobs among its many branches such as broadcasting stations, Radio factories, jobbers, dealers, on board ship, commercial land stations, and many others. Many of the six to ten million receiving sets now in use are only 25% to 40% efficient. This has made your big chance for a spare time or full time business of your own selling, installing, repairing sets.

**So Many Opportunities You Can Make Extra Money While Learning**

Many of our students make \$10, \$20, \$30 a week extra while learning. I'll show you the plans and ideas that have proved successful for them—show you

**I Will Train You At Home In Your Spare Time**

I bring my training to you. Hold your job. Give me only part of your spare time. You don't have to be a college or high school graduate. Many of my graduates now making big money in Radio didn't even finish the grades. Boys 14, 15 years old and men up to 60 have finished my course successfully.

**You Must Be Satisfied**

I will give you a written agreement the day you enroll to refund your money if you are not satisfied with the lessons and instruction service when you complete the course. You are the only judge. The resources of the N. R. I. Pioneer and Largest Home-Study Radio school in the world stand back of this agreement.

**Get My Book**

Find out what Radio offers you. My 64-page book, "Rich Rewards in Radio" points out the money making opportunities the growth of Radio has made for you. Clip the coupon. Send it to me. You won't be obligated in the least.

*This Book points out what Radio offers you Get a copy!*



**Address**

**J. E. Smith, Pres.**

**Dept. 44Q**

**National Radio Institute  
 Washington, D. C.**

**This coupon is good for a FREE copy of my Valuable Book Mail it NOW!**

J. E. Smith,  
 President,  
 Dept., 44-Q  
 National Radio Institute, Washington, D. C.

Dear Mr. Smith: Send me your book. I want to know more about the opportunities in Radio and your practical method of teaching at home in spare time. This request does not obligate me to enroll and I understand no agent will call on me.

Name.....Age.....  
 Address.....  
 City.....State.....

# Radio Listeners' Guide and Call Book

*A Quarterly Magazine*

Volume III

Number 3

JANUARY, 1929

## Contents of This Issue

	Page		Page
Radio Broadcast Stations of the U. S. by Call Letters .....	17	The Hammarlund-Roberts Hi-Q 29 .....	66
Radio Broadcast Stations of the U. S. by Wavelengths .....	29	The Thordarson Two-Stage Phonograph Amplifier .....	70
Radio Broadcast Stations of the U. S. by States and Cities .....	32	The Braxton-King Shield Grid Short Wave Set .....	72
Radio Broadcast Stations of Canada by Call Letters .....	34	The Sargent-Rayment Seven .....	74
Radio Broadcast Stations of Canada by Provinces and Cities .....	36	The Halldorson A.C. 56 Receiver .....	77
Foreign Broadcast Stations, including U. S. Possessions .....	38	How to Build a Screen Grid All-Electric Receiver .....	80
Short Wave Radio Stations of the World .....	44	A Shield Grid Short Wave Converter ..	84
The Business of Selling Custom-Built Sets .....	49	A High Quality Radio and Phonograph Amplifier .....	86
The Qualifications of a Radio Service Man .....	52	The Harkness "Screen Grid DeLuxe" ..	88
Building a Corner Cabinet for the Radio Set .....	54	The Aero Chronophone .....	91
The S-M "Round-the-World-Four" .....	58	An Amplifier and Power Supply for Television .....	94
The Aero Metropolitan A.C. Four .....	61	Electrifying the Battery Set with the Knapp "A" Power Unit .....	96
		The Listeners' Accessory Guide .....	99
		The Radio Set Market .....	102

### RADIO LISTENERS' GUIDE AND CALL BOOK *A Quarterly Magazine*

VOL. III, No. 3

JANUARY, 1929

Published quarterly by The Consrad Co., Inc., 230 Fifth Ave., New York, N. Y., telephone number Ashland 9344; H. Gernsback, President; S. Gernsback, Vice-President and Treasurer; I. S. Manheimer, Secretary. Price 50c a copy; subscriptions \$1.75 a year in the United States of America, Canada and all countries within the domestic postal zone; elsewhere \$2.00 a year, payable in advance. Subscriptions only acceptable in U. S. currency or stamps. No foreign currency or stamps. Checks and money orders should be drawn to the order of THE CONSRAD CO., Inc.

Publishers are not responsible for loss of manuscripts, although every precaution is taken with such manuscripts, upon receipt thereof.

When subscribing to RADIO LISTENERS' GUIDE AND CALL BOOK, send your name and remittance to The Consrad Company, Inc., 230 Fifth Ave., New York, N. Y. Mention that you desire to subscribe to same. We also publish and distribute CONSRAD PATTERNS, E. I. COMPANY BOOKS, etc. Write clearly.

Entered as second class matter, March 10, 1925, at the Post Office at New York, N. Y. under the Act of March 3, 1879. Additional entry at the Post Office at Dunellen, N. J. Copyrighted, 1928, by The Consrad Co., Inc., N. Y. Printed in U. S. A.

RADIO NEWS

Published by the Same Management:  
SCIENCE AND INVENTION

AMAZING STORIES

General Advertising Dept., 230 Fifth Ave., New York City

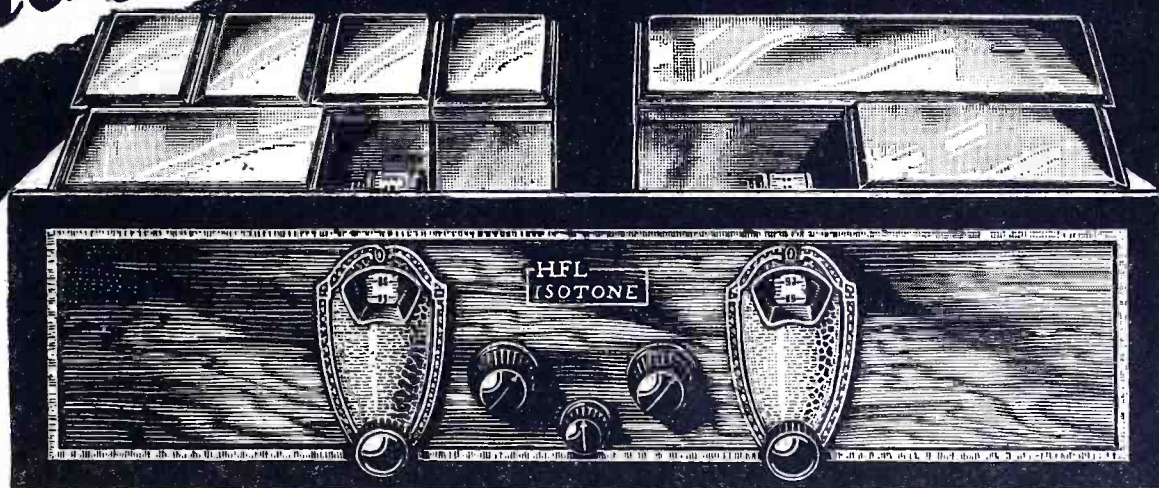
ADVERTISING REPRESENTATIVES

R. V. Tobin, 230 Fifth Avenue, New York, N. Y.  
S. B. Darmstader, 326 W. Madison St., Chicago, Ill.

A. J. Norris Hill Co., 5 Third St., San Francisco, Calif.  
412 West 6th St., Los Angeles, Calif.  
Leary Bldg., Seattle, Wash.

# HFL

**Distance Range That Staggers the Imagination!**  
**With the Wonder Receiver of the Century**



## The Model 10 HFL Isotone

**SCREENED GRID . . . CUSTOM BUILT . . . RADIO PHONOGRAPH**

**THE HFL Isotone is unquestionably the most sensitive receiver that the world has ever seen.** It will absolutely out-distance all other receivers regardless of price or type of construction. The amazing sensitivity of the HFL screened grid amplifier remains unequalled. No other commercial amplifier permits a gain of 65 per stage *under actual operating conditions.* The HFL Isotone is the supreme radio achievement. Its position has been definitely established in radio laboratories the country over.

### 2000-3000 Mile Range

So sensitive is the HFL Isotone that stations over 2000 miles away *have to be turned down.* Tremendous volume is obtained from stations all over the North American continent. The HFL Isotone will receive any station in the world that is putting enough signal voltage into the antenna to actuate the first tube in the receiver.

### One Spot Tuning

The 450 kilo cycle screened grid amplifier allows absolute one spot tuning. Extreme selectivity is gained by hand tuning each transformer with a small variable condenser. An entirely new method of control permits the tubes to be operated in their most sensitive condition just below the

oscillating point. The HFL Isotone will actually select an 8 kilo cycle band when the amplifier is worked at maximum. Dual detection (an exclusive HFL development) allows reception of the weakest signals and still permits the undistorted handling of powerful locals.

### A.C. or D.C. Operation

Through the use of an ingenious system of filament control, the HFL Isotone operates perfectly with batteries or the special HFL-A.C. power supply. The same tremendous reserve power is available with batteries. The same crystal clear tones are developed with A.C. Only 30 mils. of plate current are required by the entire receiver *including the two power tubes.*

### Phonograph or Radio

A special method of switching and ballasting allows an instant choice of phonograph or radio music by simply throwing the master control switch on the front panel. Both kinds of music are so amazingly realistic that no human ear can discern the difference between an original selection and an HFL reproduction. An automatic ballasting shunt—another exclusive HFL feature—prevents audio tube overloading when the six radio frequency tubes are *disconnected during phonograph operation.* The three stage, push pull audio amplifier is a marvel of electrical design. Not only does it faithfully reproduce every musical frequency, but it actu-

ally corrects the flaws in broadcast transmissions and phonograph records.

### 45 Minute Construction

The HFL unit method of construction is the sensation of the 1929 radio season. Every item necessary to build a perfect Isotone comes in a factory sealed carton. Each of the three main units is wired and laboratory tested at the factory. *Only ten wires* are connected by the set builder. An exact, progressive method of assembly eliminates every chance of error. We stand ready to prove, at any time, that a standard HFL Isotone can be fully constructed in less than forty-five minutes.

### Absolute Guarantee

We guarantee, absolutely, that a standard HFL Isotone receiver operating under favorable conditions will receive over a distance of not less than 1500 miles. We guarantee every HFL unit to be mechanically and electrically perfect. Any unit believed defective will be immediately replaced at no extra charge. We reserve the right to select a location and *prove by demonstration* that it will receive over 1500 miles.

*Set Builders write for special data*

**Free circuit diagrams and all information**

**Mail this Coupon Today ~**

**HIGH FREQUENCY LABORATORIES**  
 28 North Sheldon Street  
 Chicago, Illinois

### SEND THIS NOW!

HIGH FREQUENCY LABORATORIES  
 Office 2-28 N. Sheldon St., Chicago, Ill.

Gentlemen:  
 Without obligation please send your new ISOTONE booklet.

Name \_\_\_\_\_

Address \_\_\_\_\_

City \_\_\_\_\_ State \_\_\_\_\_

Please print plainly

# Index To Advertisers

<p><b>A</b></p> <p>Acme Wire Co. ....114          Aero Products Co., Inc. ....119          Aerovox Wireless Corp. ....133          All Radio Co. ....135          Allied Radio Corp. ....6, 121          American Radio &amp; Merc. Co. ....124          American Sales Co. ....124          American Transformer Co. ....117          Arcturus Radio Co., Inc. ....114</p> <p><b>B</b></p> <p>Barwik Co., The 114, 123, 126          128, 131, 132, 135, 139, 141, 142          143          Braun Co., W. C. ....114, 118, 144          Browning-Drake Corp. ....142</p> <p><b>C</b></p> <p>Carter Radio Co. ....126          Clarostat Mfg. Co. ....139          Consumers Radio Co. ....136          Cornish Arms Hotel ....116          Cornish Wire Co. ....141</p> <p><b>D</b></p> <p>DeJur Amsco Corp. ....143          Deutschmann Co., Tobe,          Inside Front Cover          Dresner Radio Mfg. Corp. ....139</p>	<p><b>E</b></p> <p>Ekko Company ....116          Electrad, Inc. ....137          Elkon, Inc. ....111</p> <p><b>F</b></p> <p>Frost, Inc., Herbert H. ....8</p> <p><b>H</b></p> <p>Hammarlund Mfg. Co. ....4          Hammarlund-Roberts, Inc. ....12          High Frequency Laboratories ..3          Harkness, Inc., Kenneth.....127</p> <p><b>I</b></p> <p>Independent Electric Works ....125          International Correspondence          Schools ....132          International Resistance Co. ....131</p> <p><b>J</b></p> <p>Jappe Co., H. ....15          Jewell Electrical Instrument Co. 7</p> <p><b>K</b></p> <p>Karas Electric Company ..126, 133          Knapp Electric Co., 13, 114, 137          139, 141, 142, 143</p>	<p><b>L</b></p> <p>Leutz, Inc., C. R. ....5</p> <p><b>M</b></p> <p>Midwest Radio Corp'n.,          Inside Back Cover          Mississippi Valley Radio Co. ..113</p> <p><b>N</b></p> <p>National Company, Inc. ....128          National Radio Institute ....1</p> <p><b>P</b></p> <p>Polachek, Z. H. ....137          Polk, J. L. ....131          Polymet Mfg. Co. ....143          Premier Electric Co. ....133          Press Guild, Inc. ....112, 140</p> <p><b>R</b></p> <p>Radiall Co. ....141          Radiart Labs. ....124          Radio Association of America ..16          Radio Equipment Co. ....136          Radio Institute of America ....11</p>	<p>Radio Specialty Co. ....134          Royal-Eastern Electrical Supply          Co. ....128</p> <p><b>S</b></p> <p>Scott Transformer Co. ..Back Cover          Setbuilders Supply Co. ....123          Shanklin Mfg. Co. ....142          Silver-Marshall, Inc. ....14          Sterling Mfg. Co., The ....10</p> <p><b>T</b></p> <p>Thordarson Electric Mfg. Co. ..109          Townsend Laboratories ....124          Transformer Corporation of          America ....137</p> <p><b>U</b></p> <p>Underground Aerial Systems ..9</p> <p><b>W</b></p> <p>Walker Co., The Geo. W. ....110          Western Radio Mfg. Co. ..120, 135          Wholesale Radio Service Co. ..121</p> <p><b>X Y Z</b></p> <p>X-L Radio Labs. ....126          Yaxley Mfg. Co. ....129</p>
--	---	---	---

## The Parts You Use

**Are More Important**

**Than the Circuit**

Any modern radio circuit will give good results—if carefully built with reliable parts.

It will perform just as well and no better than its poorest part.

The difference in price between the best and the mediocre is far less than the difference in performance.

Why build to a price when what you want is quality?

Hammarlund parts cost no more than you often pay for inferior parts.

Hammarlund parts cost less in the long run and you have the satisfaction of knowing that they are backed by seventeen years of experience and have the unqualified endorsement of the world's leading radio engineers.

If your dealer can't supply you write direct to us.



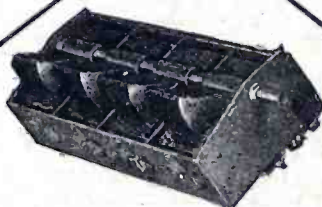
**Knob Control DRUM DIAL**  
 Beautiful bronze escutcheon. Illuminated scale. Control knob can be placed anywhere on panel. Durable mechanism will outwear ten receivers. No back-lash.



**The Famous "MIDLINE" CONDENSER**  
 Radio engineering is a never devised a finer tuning instrument. Has every modern feature, including full-floating rotor and ball bearings.



**Equalizing CONDENSER**  
 Useful for equalizing the units of a multiple tuning condenser or neutralizing R.F. circuits. May be attached directly to socket binding posts or to variable condensers. Small size permits use in limited space. Bakelite base, mica dielectric, heavy phosphor-bronze spring plate.



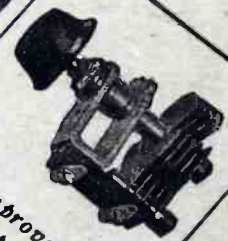
**Battleship CONDENSER**

Die cast frame; free-moving rotor. Sections matched to within 1/4 of 1% of each other at all points.



**Shield-Grid COILS**

Low resistance, space-bound self-supporting. 2" in diameter. High impedance primary. High R.F. transformer activity. Antenna coupler also has three taps.



**Improved "HAMMARLUND, JR."**

A new model Hammarlund Midget Condenser of simpler, stronger construction. Has locking device for fixing rotor plates in any position.



**Radio-Frequency CHOKE COIL**

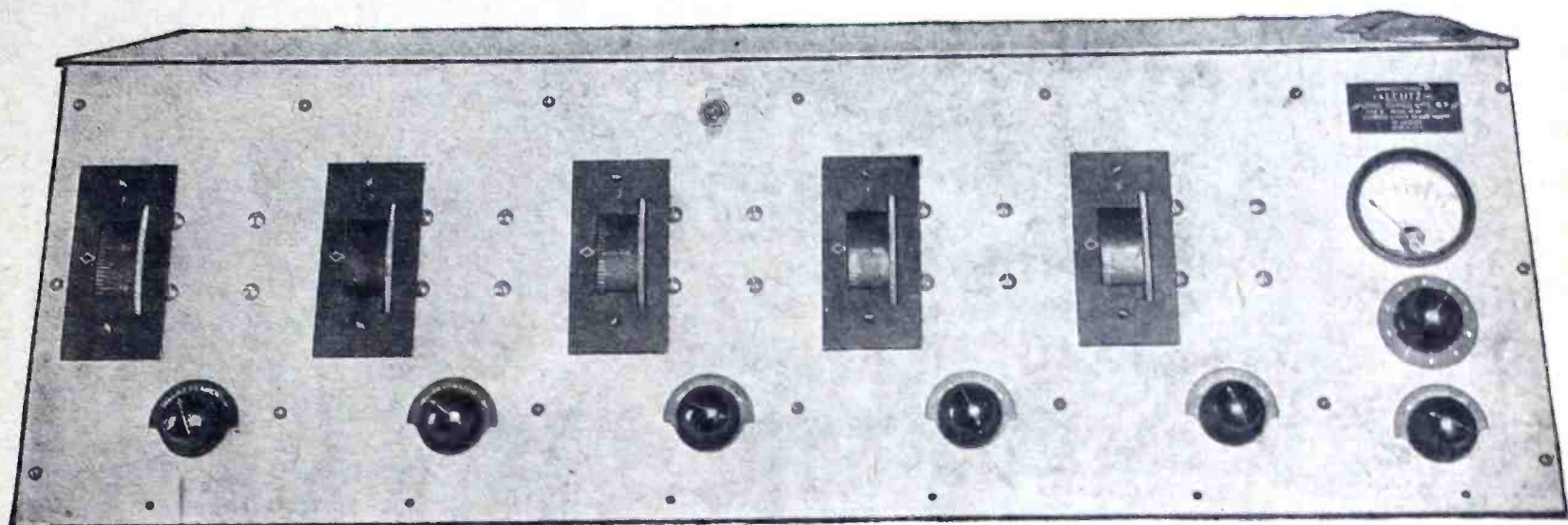
Special winding and impregnating makes for unusual efficiency. Two sizes: 85 and 250 millihenries.

Write for folders

For Better Radio  
**Hammarlund**  
 PRECISION  
**PRODUCTS**

HAMMARLUND MANUFACTURING CO.  
 424-438 W. 33rd Street, New York



**THE NEW LEUTZ****UNIVERSAL TRANSOCEANIC****9 TUBES****WITH FOUR UX222's****AND 2—UX210's OR 2—UX250's**

**D**URING the past two years less than one thousand Universal Transoceanic Phantoms have been manufactured. They have been shipped to points in every state in the Union, every province of Canada, Alaska, Hawaii, Philippine Islands, Porto Rico, and practically every foreign country in the world. In practically every instance the new owner of the Transoceanic Phantom has written to us expressing complete satisfaction and reporting results far superior to any competitive makes used in the same vicinity.

There is no mystery connected with the superior performance of Leutz radio receivers. In 1922, seven years ago, Leutz had 8 and 10 tube Super-Heterodynes on the market, while the nearest competitive set had three tubes. Likewise, Leutz had the first Shielded Set, First Single Control License under the Hogan Patent, first resistance-coupled audio, first interchangeable tuned radio frequency transformers, first metal cabinet, and many other original features used two years ahead of other designers.

Powerful radio receivers, each perfect in every respect, cannot be built hurriedly. Each Leutz radio receiver is made to special order only. The average time required for delivery is three to six weeks after receipt of confirmed order. Leutz receivers are not sold on a trial basis; anyone contemplating the purchase of a Leutz receiver need only inquire from any of our customers and they will be assured that they will obtain the best radio receiver in the world.

The present Universal Transoceanic Phantom Special has the most powerful tube arrangement one could desire, viz., Four 222 Screened Grid Radio Frequency Stages, 200A Super-Detector, four audio stage, two of which are in a push-pull system using either two 210's or two 250's, output adjustable for a small room, or sufficient for six Dynamic Speakers distributed over a battleship.

Only a limited number of Transoceanic Phantoms can be produced this season, and our production is already sold considerably ahead. We suggest placing Phantom orders three to four weeks ahead to prevent disappointments in delivery.

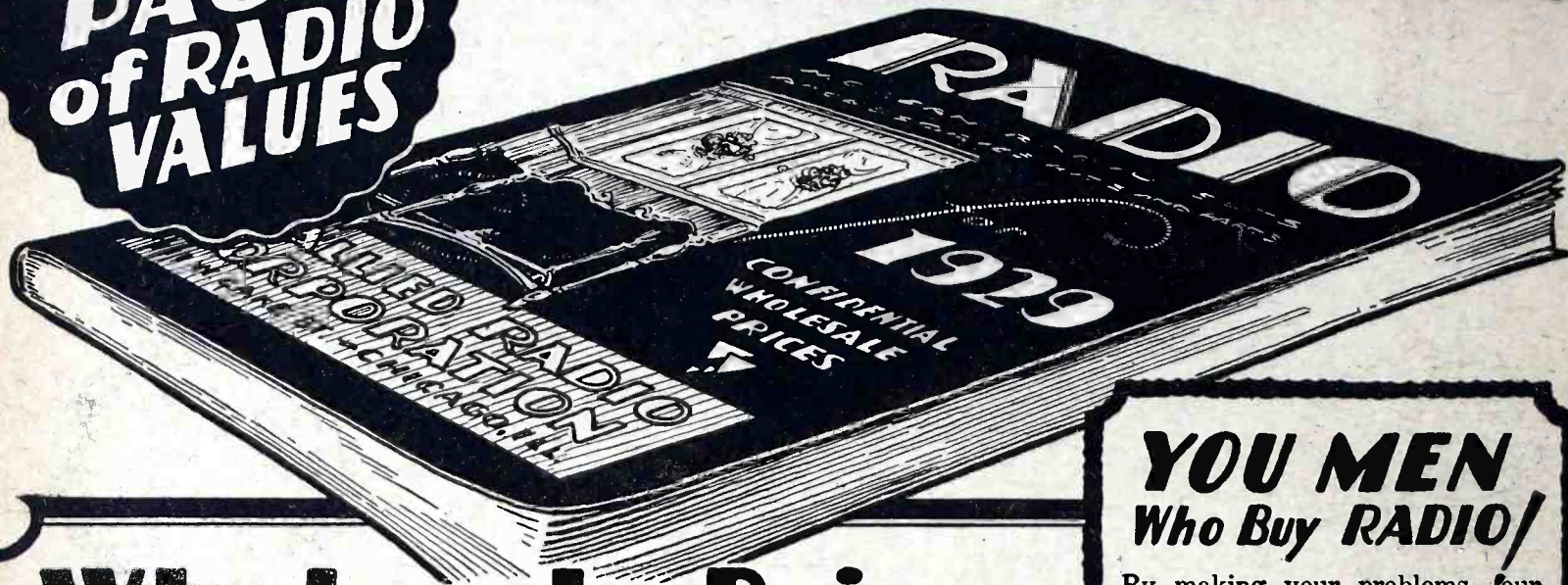
*THE NEW LEUTZ LITERATURE IS THE MOST INTERESTING RADIO LITERATURE YOU EVER READ—DROP A LINE FOR YOUR COPY NOW*

**C. R. LEUTZ, Inc.****195 Park Place****Long Island City****New York, U. S. A.**

CABLES "EXPERINFO" NEW YORK

**164  
PAGES  
of RADIO  
VALUES**

# A NEW CATALOG JUST OFF THE PRESS

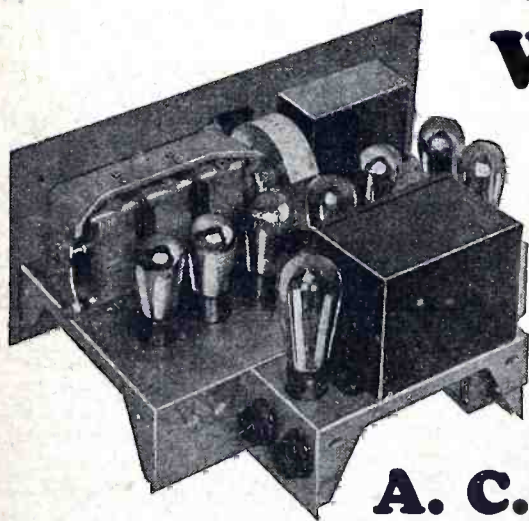


## Wholesale Prices

**T**HIS big new catalog heralds a new era in radio. Never before have you been offered such variety—**such quality**—such sterling value in radio as you are now offered in this large new catalog. In it, **wholesale prices** are not a myth—but *actual* reality. You will marvel that such merchandise, comprising everything that is **new and worthwhile** in radio can be offered at such prices. Here you will find high quality that is not high priced. If you are interested in radio you cannot afford to be without the **Allied Catalog**.

### SET BUILDERS!

Set Builders, Amateurs and so called "Hams" will delight in the *unusual variety*—and **remarkable values** that are offered in standard kits and parts. Tremendous stocks—**real organization**—prompt shipping service all combine to make Allied your ideal source of supply.



**A. C.**

### ELECTRIC SETS

Allied offers you a new—complete line of A-C Receivers, available in either chassis form or in a wide variety of beautiful console models. Prices range from \$32.95 to \$199.00. Dollar for dollar they stand out as one of the season's leading receivers. Engineered to unusual perfection they offer you features found only in the highest priced sets.

### YOU MEN Who Buy RADIO!

By making your problems our problems, we know the service you require—and to render you such service the entire Allied organization is dedicated—to give you the service you have a right to expect. Tremendous stocks, remarkable values and a real desire to serve, all combine to make Allied your ideal source of supply.

### RADIO DEALERS!

The live radio dealer—the man who keeps pace with the rapid advance of radio will find much of **real interest** in the Allied Catalog. New A-C Sets, D-C Sets, Dynamic and Magnetic Speakers, television equipment, in fact **everything** that an impatient radio public is demanding.

## What Allied offers you!

Allied Service will prove a revelation to you in what radio service can really be. Allied Executives backed by years of training in radio are practical men. They know radio. Their vast experience has built up around them an organization trained to serve. Months of effort have built up here a tremendous reserve of stock that makes for prompt shipments; and this stock is new stock comprising the seasons pick of such prominent manufacturers as Silver-Marshall Tyrman, Aero, Hammerlund-Roberts, etc.

### You Profit When You Buy Right

Buying right is half the battle. From the small set builder to the large dealer, your success depends upon gauging the public pulse of radio and in **buying right**. Everything that is new in radio—the items the radio public is now demanding are here, ready for your call. Write now—the catalog is **free** for the asking.

**Write for Catalog Now**

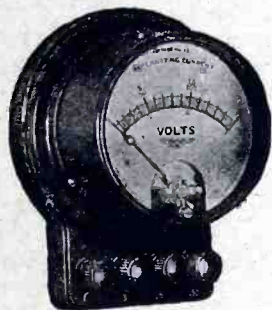
**Allied Radio  
CORPORATION**

**711 W. LAKE ST. Dept. K-1 CHICAGO, ILL.**



# JEWELL INSTRUMENTS

*Durable  
Reliable  
Satisfactory*



**Pattern No. 77**  
*Portable Instrument—for the  
Set Owner and for Service  
Work*

In the Pattern No. 77 is provided an instrument which is very flexible in its adaption to the problems arising with the universal adoption of A.C. radio sets and allied equipment. It enables checking line and filament voltages and also the conditions of transformer primaries and secondaries in charging devices and power supply units. Trouble in the devices named may be quickly located with the Pattern No. 77, for its combination ranges of 0-3-15-150 volts are ample to cover all ordinary tests. It is a good instrument for the set owner and one of the best additions that can be made to a service man's kit of service equipment.



**Pattern No. 199**  
*Radio Set Analyzer—for the  
Dealer and Service Man*

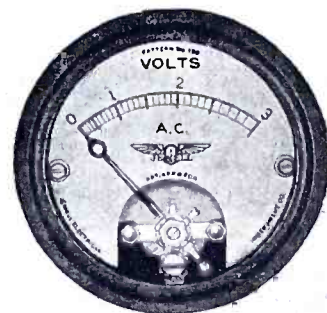
A radio set analyzer offered to the dealer and service man in the belief that it is the most useful and reliable service instrument ever produced. The workmanship and material are of the finest throughout and every test which will give useful information of the workings of a radio set and its accessories has been provided for. It tests A.C. and D.C. tubes, A and B eliminators, batteries, circuits, grid, plate and cathode voltages, plate milliamperes, chargers, line voltage, etc. Ranges of the instruments are 0-4-8-16-160 A.C. Volts, 0-7.5-75-300-600 D.C. Volts, and 0-15-150 Milliamperes. All D.C. voltage ranges have a resistance of 1000 ohms per volt. It is the favorite instrument of dealers and service men.

Durable — Reliable — Satisfactory — a good description of Jewell instruments and also the reasons for the general acceptance as the testing standard by the radio fraternity.

Every phase of radio testing requirements is covered by the extensive line of Jewell radio instruments. Manufacturers, jobbers, dealers, service men, amateurs, set builders and set owners—all have found Jewell instruments the solution to their various testing difficulties.

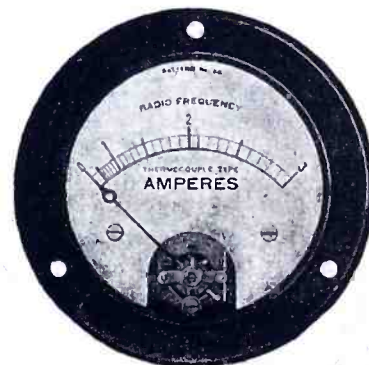
Jewell instruments are sturdy and accurate and will stand an unusual amount of hard usage without becoming inaccurate. They are popular because there are so many styles and ranges from which to choose and because they are so entirely satisfactory.

Ask your radio dealer for information regarding Jewell instruments, or write us for a copy of our radio instrument catalog No. 15-C. It is yours on request.



**Pattern No. 190**  
*Panel Instrument—for the  
Set Owner and Builder*

A flush type, 2-inch, alternating current instrument of moderate size and good appearance. It will be found very valuable for filament control of the new alternating current tubes for it is frequently found that a particular setting of the filament voltage is required to eliminate objectionable hum. It is furnished in ranges of 0-1.5, 0-3, 0-5, 0-8, 0-10, 0-15 and 0-150 volts. The movement of Pattern No. 190 is of the moving vane type with special modifications for the small size case. The instrument is accurate and is designed for continuous service with a very small energy consumption.



**Pattern No. 64**  
*Transmitting Instrument—for the  
Amateur*

This instrument is a member of the famous Jewell Trio of transmitting instruments for amateurs. It is a thermocouple type and is guaranteed to stand an overload of 30%. The loss in the instrument is less than one-half of the minimum required by the Navy. The thermocouples are made from special furnace alloys of non-oxidizing nature and are worked at a low temperature to give a high overload capacity. The case is three inches in diameter with a 3/4-inch flange. Scales are silver etched and all visible parts are silver plated. For the amateur and experimenter in short wave work, no better instrument is available.



**"28 Years Making Good Instruments"**

**Jewell Electrical Instrument  
Company**

**1650 Walnut Street, Chicago, Illinois**

DESIGNED TO RENDER UTMOST IN SERVICE

# FROST-RADIO

PRICED TO GIVE YOU UTMOST IN VALUE

## A Complete Line That Was Built For Your Specific Requirements



**FROST VOLUME CONTROL**

Gives complete, stepless and wonderfully smooth control of volume and oscillation. Wearproof roller contact arm, Bakelite case and dust cover. \$2.00 and \$2.25.

Frost-Radio offers you the finest and most complete line of radio parts available. This great line was designed and built with the specific requirements of the set builder in mind. Consequently, when you go to your dealer and order these parts you are sure of obtaining the very finest on the market, built by engineers with many years of experience in radio parts manufacture. Obviously, your receiver will give better, finer and much more dependable results when you use these superior parts made by Frost-Radio.



**FROST VOLUME CONTROL WITH A. C. SWITCH**

We equip our famous Volume Control with approved A.C. Snap Switch tested to carry 250 volts at 3 amperes, so that both switch and volume control may be handled by single knob. \$2.75 and \$3.00.



**FROST GEM VOLUME CONTROL**

Identical with our standard size Volume Control units except in size. Gem units are only 1 1/2 in. in diameter, and 5/8 in. thick. Great space savers. \$2.25 and \$2.50.



**FROST VOLUME CONTROL WITH D. C. SWITCH**

Equipped with sturdy German silver switch mounted on Bakelite panel, and with switch points fitted with sterling silver contacts, this Volume Control gives quick operation, positive-locking off position and saves space. For battery operated sets. \$2.35.



**FROST GEM RHEOSTATS**

Made to deliver a service that is not usually expected from little rheostats like these. Mighty good little rheostats, taking up little space and supplied either plain or with D.C. switch. Easy to solder to. Plain, 75c. With switch, \$1.00.



**FROST BAKELITE RHEOSTATS**

Long the standard air cooled Bakelite Rheostat, as well as the original of this type. Resistance wire is wound on die cut Bakelite strip over moulded Bakelite frame. Wide choice of resistances. \$1.00 to \$2.50.



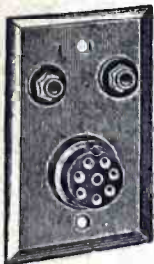
**FROST BAKELITE RHEOSTATS WITH D. C. SWITCH**

Cleverly mounted German silver D.C. battery switch is firmly attached to Bakelite panel on back of rheostat, affording quick on and off control of filament current. 2 to 75 ohms. \$1.35.



**FROST HUM BALANCER**

Simply turn the slotted head shaft with screw driver to regulate. Smooths the ripple out of A.C. current. Precision built. \$1.00.



**FROST CONVENIENCE OUTLETS**

Fits std. outlet box. Brush brass or Bakelite plates. \$1.00 to \$3.25.



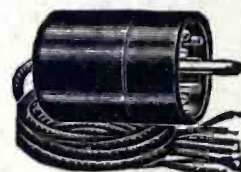
**FROST MOULDED MICA CONDENSERS**

Cannot be affected by moisture or climate. Moulded Bakelite with finest mica dielectric. Easy to attach. 45c to 90c.



**FROST APPROVED A. C. SWITCH**

Single hole mount 110 volt A.C. Snap Switch. Tested to 250 volts, 3 amps. Underwriters' approved. 75c.



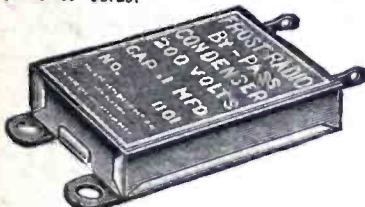
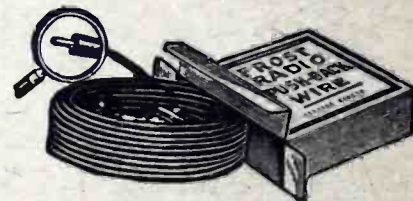
**FROST ALL-BAKELITE CABLE PLUG**

Terminals cannot work loose even when overheated. Color code moulded into Bakelite. Best quality cable, with colored rubber insulation on wires. Has 5 ft. seven strand braid covered cable. Plug and cord only. \$2.25. Baseboard or sub-panel socket, 75c.



**FROST PUSH-BACK HOOKUP WIRE**

Slide back the braid for soldering, then slip braid back over soldered joint. No. 18 double cotton covered, impregnated wire, tinned. 50 ft. roll, 80c.



**FROST BY-PASS CONDENSERS**

Made from finest materials, thoroughly seasoned, vacuum impregnated and hermetically sealed. Accurate capacities and conservative voltage ratings. 1 to 2 mfd. 80c to \$2.00.



**FROST FIXED RESISTANCES**

Die cut flexible Bakelite strip holds windings firmly in place. Terminals are staked into Bakelite. .4 to 1000 ohms. Also, as center tapped resistances, 6 to 64 ohms. 150 to 50c.

## Mail Coupon Below For Our Complete 16-Page Catalog

### HERBERT H. FROST, INC.

Main Office and Factory: ELKHART, IND.  
New York City                      CHICAGO                      San Francisco

### FROST HEAVY DUTY FILTER CONDENSERS

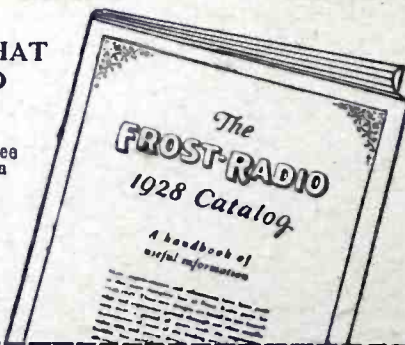
We use only finest quality linen paper and highest grade foils in building these Filter Condensers. Conservative ratings. Designed to give longest service with entire freedom from trouble. .5 to 2 mfd. \$1.40 to \$7.00.

### FROST BLOCKING CONDENSERS

Every particle of material used is of tested quality. Entire condenser enclosed in hermetically sealed cases after vacuum impregnation. Gold bronze lacquer finish; tinned terminals. \$18.00.

### HERE'S A BOOK THAT YOU SHOULD SEND FOR TODAY

The Frost Radio Catalog is free for the asking—and contains a vast amount of valuable information about rheostats, volume controls, switches, jacks, plugs, condensers, circuits, etc. It's a book every fan should have. Fill out and mail coupon to-day for your copy.



HERBERT H. FROST, Inc.

160 No. La Salle Street, Chicago

Send me your new Frost Data Book, containing valuable radio information and facts about your complete line of parts.

My name .....

Street Address .....

City ..... State .....

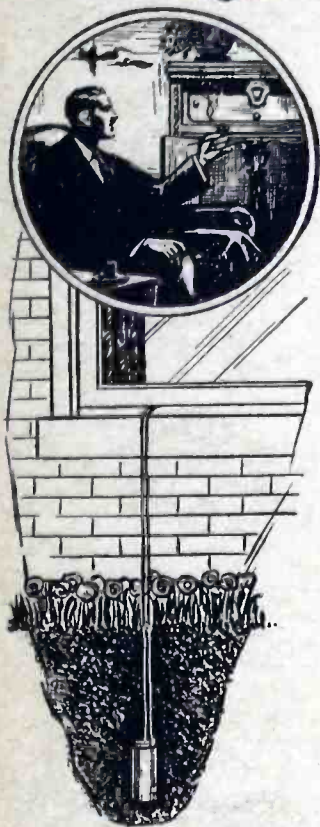
(Are you a professional set builder?.....)



# AVOID STATIC- DISTORTION- INTERFERENCE-

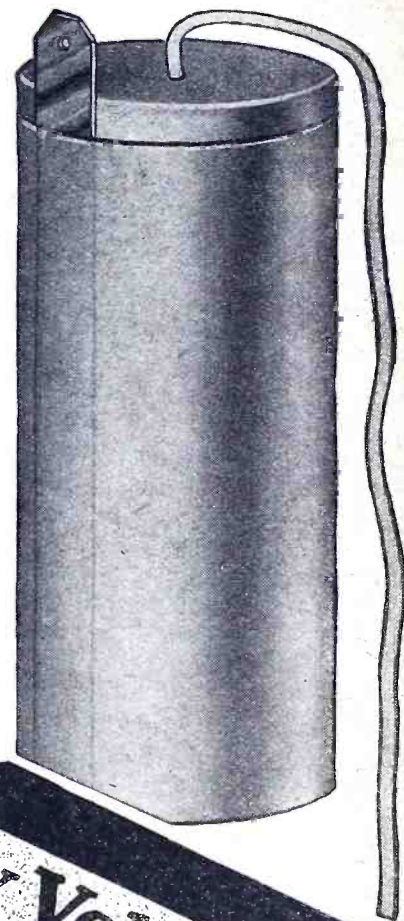
Now Make Your Radio Clear As a Bell  
With Marvelous New Underground Aerial!

Did you know that radio waves go through the ground just as they do through a building? If you had your set down in a deep mine, you'd get the program just as you do at home! In fact—and here's the surprising discovery that is revolutionizing radio reception—you'd probably get much better results. Scientists say that when the receiving antenna is below the surface of the ground, the earth absorbs practically all the static and other interference, and allows practically only the clarified tone to reach the set. Starting from that important fact, radio engineers worked out the SUB-AERIAL. Set owners everywhere are now enjoying real radio pleasure with this marvelous new invention.



## How SUB-AERIAL Works

Anyone can install the SUB-AERIAL in a few minutes. Simply bury it about two feet below the surface of the ground and bring the lead-in wire to your set. SUB-AERIAL then takes the radio waves from the ground and brings them to you sweet toned and clear as a bell. Howls and shrieks due to static-laden air conditions are reduced and your *real* radio enjoyment begins. SUB-AERIAL never needs to be touched again.



### PROOF

Test after test has been made with SUB-AERIAL with amazing results. Radio engineers, magazines and fans heartily endorse SUB-AERIAL.

May 8th, 1928.  
"I am very glad to state that after testing many Aerials in my Laboratory I find your Sub-Aerial is the best for clarity of tone and elimination of static, also for greater volume and selectivity. Your Sub-Aerial will fill a long-felt want among the Radio Fans."

A. B. Johnson,  
Radio Engineer.  
August 31st, 1928.

"I received my Underground Aerial all O. K. It has an aerial boat I have ever seen. I have used every aerial on the market since I have been a radio fan. The first day I installed it I got distant stations that my set had never touched before. It wasn't good radio weather either. I got stations in the East that I had never dreamed of getting and with absolute clearness and without static or interference. I heartily recommend your instrument to any lover of good radio reception."

A. N. Whitau,  
Box 565, El Reno, Okla.

## 25 Year Guarantee

Any SUB-AERIAL installed that proves defective either in workmanship or materials or which deteriorates within 25 years will be replaced free of charge; also we will pay \$1.00 for any such new replacement.

## TRY IT FREE!

Don't hesitate to send for SUB-AERIAL on Free Trial. You take no risk. When you get it, test it against your overhead aerial and compare the two. If you are not astonished at the difference—if SUB-AERIAL does not bring in reception with marvelous tone value, clear as a bell—if it doesn't give surprising volume and distance—if you are not more than satisfied you don't pay us a cent. Send coupon for the fascinating story of SUB-AERIAL. Do it NOW!



Mail This  
Coupon Today

**UNDERGROUND AERIAL SYSTEMS**  
St. Clair Bldg., Dept. 6-T.S. Cor. St. Clair & Erie Sts., Chicago, Ill.  
*Get Reception You've Always Wanted*

UNDERGROUND AERIAL SYSTEMS, Dept. 6-T.S.  
St. Clair Bldg., cor. St. Clair & Erie Sts., Chicago, Ill.  
Send me complete information on Sub-Aerial and Free Trial Offer. No obligation.

Name .....

Address .....

City .....

State .....

with **SUB-AERIAL**

## DYNAMIC Speaker \$40

The powerful Sterling Dynamic Chassis is superior to all others, especially on sets not having super-power amplification. Easy to install into your own cabinet.



## POWER Amplifier \$38

The R-250 Sterling Power Amplifier uses the type 210 or 250 Super-Power Tube. Ideal for Dynamic Speakers. Simple to connect.



## VARI-TONE Speaker \$25

A magnetic speaker that is actually better than many Dynamics on ordinary amplification. Beautifully finished in two-tone deep bronze. Also available as a chassis for \$14.



## POWER UNITS Simple to connect

The R-81 Sterling "B" Power shown costs \$28.50, complete. The R-93 VA Power costs \$37.50 complete.

# Modernize your radio

The newest sets have—

- 1—Dynamic Speaker
- 2—Super-power Amplification
- 3—Electric Socket Operation

You don't have to buy a new set to have these features. Sterling accessories will bring your present set up-to-date and you save a terrific trade-in-loss.

*Sterling products are for sale at all good dealers.*

THE STERLING MANUFACTURING CO.  
Cleveland Ohio

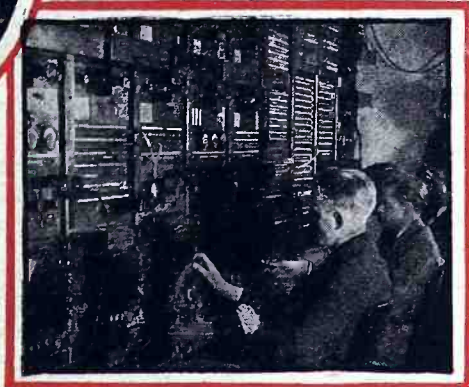
# Sterling

23 Years of Precision Manufacturing

# Pick the RADIO JOB you want and fill it in only 9 months!



**Radio Operator**  
\$90 to \$200 per month  
with all expenses paid



**Broadcast Operator**  
\$1,800 to \$4,800 a year



**Radio Inspector**  
\$2,000 to \$4,500 a year

By means of this "Big-League" home-training sponsored by Radio Corporation of America, General Electric and Westinghouse

Send for FREE BOOK about Radio.

**W**HY struggle along on less than \$45 a week? Why wait years for success that can be yours in only 9 months?

As a result of a marvelous new kind of home-study training in Radio, hundreds of men are today leading straight for financial independence! Radio pays from \$2,000 to \$25,000 a year. The work is thrilling . . . the hours are short. Vacations with pay . . . opportunities for seeing the world . . . adventure galore!

Prepare at Home with this Big Laboratory Outfit

Get the "How" as well as the "Why" of Radio—with this expert training! Only an hour or so a day—in spare time—is all you need! As part of your course, you receive absolutely free of extra charge—a magnificent outlay of apparatus. With this outfit you learn to build fine sets and solve the problems that bring big pay.

Training sponsored by

RCA . . . General Electric . . . Westinghouse

Our graduates are in big demand everywhere. They enjoy greater success because they're posted right up-to-the-minute in everything in Radio. Radio's progress each year is measured by the accomplishment of the great engineers at work in the research laboratories of RCA, General Electric and Westinghouse.



Limited space permits of only a small picture of the great outlay of apparatus given with the course.



These three Radio organi-

zations set the standards for the industry, and stand back of every lesson in the course.

Money Back if Not Satisfied

The lessons prepare you for success in all phases of Radio—manufacturing, servicing, selling, ship and shore broadcasting, Television, Photoradiograms and Radio equipment. A signed agreement backed by RCA assures you of complete satisfaction upon completion of the training—or your money will be promptly refunded.

Read This Thrilling Free Book

It gives you the real "dope" about Radio and describes in detail the famous training that has enabled us to place thousands of our students in fine positions, usually from 3 to 10 days after graduation. It may mean the turning point in your life. It tells in 50 fascinating pages and photos all about Radio's brilliant opportunities for adventure and success. Mail the coupon now—the book is absolutely free!

Radio Institute of America, Dept. L.G.-12 326 Broadway, New York.



Radio Institute of America  
Dept. L.G.-12  
326 Broadway, New York, N. Y.

Gentlemen: Please send me your big FREE 50-page book which tells about the brilliant opportunities in Radio and about your famous laboratory-method of guaranteed radio instruction at home.

Name.....

Address.....

# 4 NEW HI-Q RECEIVERS

## Custom-built To Any Pocketbook!

AGAIN Hammarlund-Roberts open the radio season with advancements in construction and performance that will be marveled at throughout the entire radio world.

This year, instead of merely one outstanding Custom-built receiver as in past years, we announce FOUR wonderful instruments—the result of the combined engineering efforts of the foremost parts manufacturers in America. FOUR brand-new models—a Junior D.C., a Junior A.C., a Master D.C. and a Master A.C. that establish a totally new standard in radio design.

The new Master Hi-Q typifies the marvelous efficiency of the entire line of 1929 Hi-Q's. A five-tube stage-shielded receiver that is built upon a solid steel chassis. Only the very finest parts in the industry are used, including the newscreen-grid tube. Circuit is a new development with a BAND-PASS FILTER, which effects absolute FLAT-TOP square cut-off TUNING for the first time to our knowledge in radio history. FLAT-TOP TUNING with 10 K.C. selectivity! "Cross-talk" is impossible with this set, for the reason that it is impossible to receive more than one station at a time, even in large cities where many powerful stations are broadcasting!

10 K.C. SELECTIVITY...ABSOLUTE FLAT TOP TUNING  
COAST-TO-COAST RECEPTION...NEW TONE QUALITY  
SCREEN-GRID TUBES . . . SHIELDED STEEL CHASSIS  
CONCEALED WIRING...SIMPLIFIED CONSTRUCTION

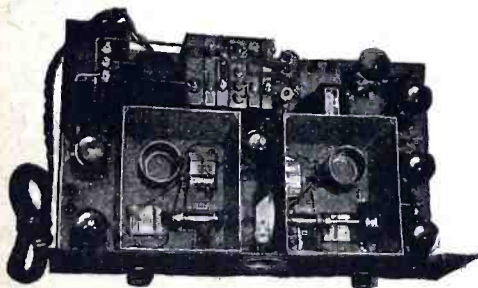
This peak achievement of Hi-Q design is a real "coast-to-coast" instrument. Stations don't merely "swish" in as with

even the best of receivers. They absolutely "CLICK" in—sharp, clear, definite. No hum, no buzz, no oscillation—nothing but the pure, natural, clear-as-crystal signal exactly as it is delivered to the microphone. There is nothing like this new Hi-Q Receiver available anywhere in any circuit at any price. Wonderful sensitivity. Wonderful selectivity. And tone quality that simply cannot be described.

The other three new Hi-Q 29 Receivers have similar qualities—each the fullest value available in the radio world—each a finer instrument than any ready-built receiver selling at \$50 to \$100 more money.

Send Now for This New  
80-Page  
Construction Manual

Biggest and most complete book ever published. Tells how to build the 4 new Hi-Q Receivers. Photos and diagrams illustrate every detail. Covers power amplifiers, tube and battery combinations, antennae, installation, short-wave adapters, house wiring and a wealth of other data on custom-built radio. Price 25c.



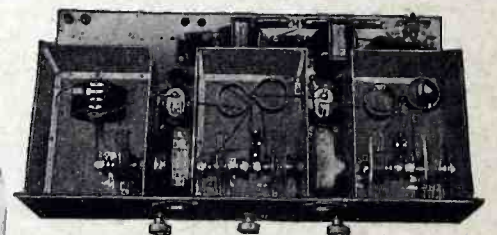
JUNIOR A. C. HI-Q 29

A screen-grid, shielded receiver made with the finest parts available. Extremely selective, sensitive, tone quality unsurpassed, simplified construction.

Junior Hi-Q 29 complete without cabinet, \$54.35. Junior A. C. Hi-Q 29 complete without cabinet, \$103.95.



Any Hi-Q Model, whether in this delightful console or one of the Hi-Q Cabinets, makes a pleasing, decorative adjunct to the finest interior.



MASTER HI-Q 29

The outstanding feature of this set is the Hi-Q Band-pass Filter, which actually effects FLAT-TOP TUNING within a 10 K. C. band. Also screen-grid tubes, completely shielded, concealed wiring. Master Hi-Q 29 complete without cabinet, \$99.50. Master A. C. Hi-Q 29 complete without cabinet, \$151.80.

HAMMARLUND-ROBERTS, INC., 1182-Z Broadway, New York

Associate Manufacturers



# NOW...4 or 6 Volts with the Improved

Operates on 105  
to 120 volts. 50  
to 60 cycles.

# Knapp "A" POWER

The only "A" Power suitable for all sets — irrespective of number of tubes — including SuperHets, Short Wave and Television receivers.

THE new Knapp "A" Power is designed for the most exacting service — super-hets, short wave and television receivers

included. I knew that if it would perform satisfactorily with these receivers that there could be no question as to its efficiency on ordinary broadcast signals. The three Elkon dry condensers, the improved choke coils and the special Elkon dry rectifier make the difference between ordinary and Knapp performance.

### No Change in Price

Even with these wonderful and costly improvements, there has been no advance in price — due to the tremendous volume going thru my plant. Remember that the Knapp is the fastest selling "A" Power on the market.

KNAPP ELECTRIC, Inc.,  
—Division of P. R. Mallory & Co., Inc.—  
350 Madison Ave., New York City



## 10

### Improvements

1. Two taps for 4 or 6 volt operation.
2. Larger filter system.
3. Three Elkon Dry Condensers instead of two.
4. Improved Choke Coils.
5. Pendant Switch Controlling "A" Power, "B" Eliminator and Set.
6. Dial for Regulating Voltage.
7. Celeron Front Panel.
8. Baked Finish.
9. Heavier Gague Metal Cover.
10. Die Cast Base Plate instead of wood.

### See your dealer today

Go to your dealer today. Most of the good ones carry the Knapp in stock. Do not accept a substitute — because only in the Knapp will you get full satisfaction as typified by the famous Knapp "A" Power. If your dealer cannot supply you send the coupon.



Mr. David W. Knapp, Pres.,  
Knapp Electric, Inc., Dept. K-5  
350 Madison Ave., N. Y. C.  
Send me complete information on the Knapp  
"A" Power.

# SM

# Build and Own The Boss of the Air

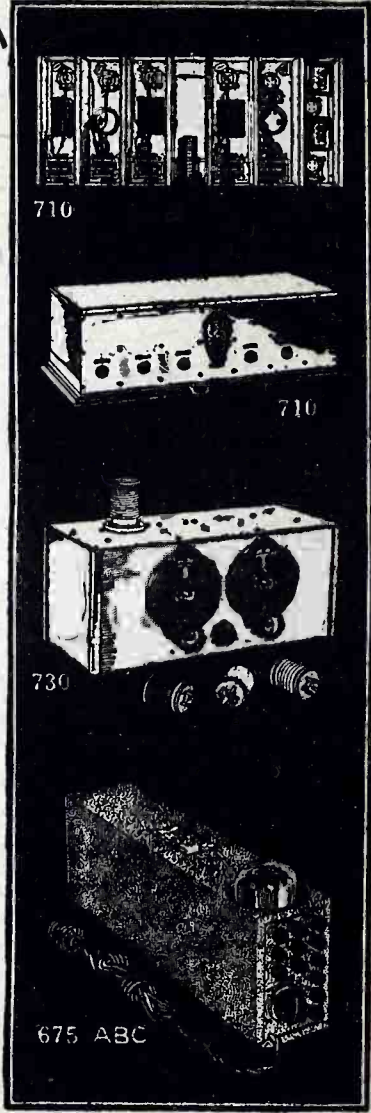
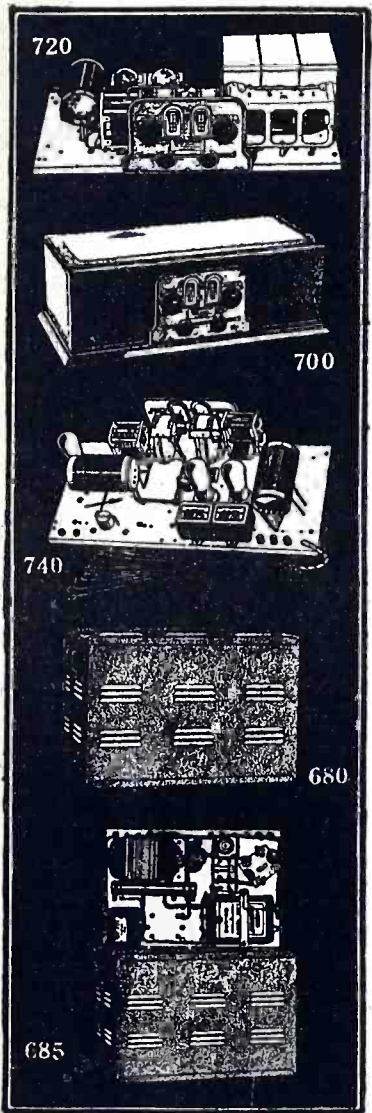
Have built up the Sargent-Ray...  
 ich I received, and believe...  
 oms radio. I can honestly say it...  
 finest thing that I have ever had from...  
 you people. The tone quality is...  
 perfect, selectivity marvelous and dis...  
 tance range unsurpassable. People that...  
 heard it in the shop have been abso...  
 lute to sell quite a few of...  
 dio Inspection, Corp., Hartford, Conn...  
 Sargent-Rayment 710. I am telling...  
 the finest set that I have...  
 ever heard of, barring nothing. I...  
 finished assembling this set Sunday, Sunday...  
 September 30th, about three o'clock. Sunday...  
 and all with good volume. The best I...  
 saw in forty-three stations in forty-eight...  
 R. C. Hodges, Creighton, Canada, and Mexico

**AGENCY Radio Doings**  
 (Continued from October 13, 1934)  
 alarm clock for 4 a. m. and...  
 turned the set on at that hour. The...  
 time and 4QC in...  
 WMMJ, KMA and some Easterners were...  
 already on the air with their early morn...  
 ing programs also.  
 in all. We were very well satisfied...  
 with the performance of the receiver...  
 not alone heard, but considerably sur...  
 passed. No repeats on both local and...  
 the quality of the set...  
 ease of operation are fac...  
 toring. We believe...  
 from either...  
 us.

You will be interested in a word of com...  
 ment on the Silver-Marshall 710 set. I want to put myself...  
 question the best receiving set of any type or de...  
 scription that we have ever demonstrated here in New...  
 York. During the evening demonstrations, we were...  
 able to tune in at will almost anything in the country...  
 other than WEAJ in this locality. It has been...  
 set for us to be able to demonstrate...  
 when you consider that our receiver...  
 is the most obtainable.

## In California or New York, Nothing Equals the 710!

"Without question the best receiving set of any type or description that we have ever demonstrated"—the above words of F. W. McDonell, a well-known New York radio engineer, typify the comments that stream in with the "station-on-every-channel" logs made with the record-demolishing S-M 710 Sargent-Rayment Seven. Using four of the most sensitive r.f. tubes made (screen-grid '22's)—five tuned circuits each with its own shielding and vernier knob—built with the complete S-M Clough audio system into an assembly where neither space, quality, nor cost has been spared—no wonder Japanese and Australian stations come in like locals on the west coast, and California stations are "regular stuff" to New York City dwellers. With such a kit, complete with beautiful aluminum cabinet, priced at only \$130.00 (\$175.00 wired)—there is but one wise course—get your order in now to your S-M Service Station or jobber!



### 720 Screen Grid Six

The new S-M 720 embodies in the most perfect form the revolution that screen-grid tubes have brought about in long-distance reception. Three of these tubes in the R.F. stages, with shielded S-M coils, bring in distant stations on the next 10 kc. channel to powerful locals! The new S-M 255 and 256 transformers set a far higher standard of tone quality than ever known before. Custom-built complete in 700 cabinet, \$102.00; complete kit, with pierced metal chassis and antique brass escutcheon but without cabinet, \$72.50.

### 700 Shielding Cabinet

Beautiful two-tone brown moire finish, with walnut finish wood base, \$9.25.

### 685 Public Address Unipac

For coverage of crowds of 1,000 to 10,000 people, indoors or outdoors, with one to twelve loud-speakers, the 685 Public Address Unipac furnishes unequalled tonal clearness. It uses one UY227, one UX226, one UX250, and two UX281 rectifiers in three stages for microphone, radio or record pick-up amplification. 685 WIRED Unipac is priced at \$160.00; or 685 KIT, \$125.00.

### 740 Coast-to-Coast Four

A time-tested and famous circuit—one R.F. stage, regenerative detector (non-radiating) and two A.F. stages—combined with immeasurably finer coils, the high efficiency of the screen-grid tube, all the gain of smooth-working regeneration, and new S-M Clough-system audios, make the 740 the greatest value in the fifty-dollar class. WIRED in 700 cabinet: 740 (for D.C. tubes) \$75; 740AC (A.C. tubes) \$78. Kit less cabinet: 740, \$51; 740AC, \$53.

### 676 Dynamic Speaker Amplifier

A single-stage power amplifier, using one 250 type power tube and one 281 type rectifier. Used with any receiver, as a third stage before a dynamic speaker, it will give wonderfully improved volume and tone quality, WIRED, \$55; KIT \$49.

### 678PD Phonograph Amplifier

A two-stage power amplifier, using a 250-type power tube; also a '26 and an '81. Used with a 110-volt D.C. dynamic speaker. Connected to a magnetic pickup on any phonograph, or to detector of a radio receiver, it gives full '50-tube volume, with unbeatable S-M tone quality. Kit, \$65.00; Wired \$73.00.

Are you receiving "The Radiobuilder" regularly? Every issue describes new and interesting radio developments. To all Authorized S-M Service Stations, it comes free of charge; to others a nominal charge is made. Use this coupon.

If you build professionally, write us about the Service Station franchises. Or if you don't build, yet want your radio to be custom-made, S-M will gladly refer your inquiry to an Authorized Silver-Marshall Service Station near you.

Silver-Marshall, Inc.  
 866 W. Jackson Blvd., Chicago, U. S. A.  
 ...Please send me, free, the complete S-M Catalog; also sample copy of The Radiobuilder.  
 For enclosed... in stamps, send me the following:  
 ... 50c Next 12 issues of The Radiobuilder  
 ... \$1.00 Next 25 issues of The Radiobuilder  
 S-M DATA SHEETS as follows, at 2c each:  
 ... No. 1. 670B, 670ABC Reservoir Power Units  
 ... No. 2. 685 Public Address Unipac  
 ... No. 3. 730, 731, 732 "Round-the-World" Short Wave Sets  
 ... No. 4. 223, 225, 226, 256, 251 Audio Transformers  
 ... No. 5. 720 Screen Grid Six Receiver  
 ... No. 6. 740 "Coast-to-Coast" Screen Grid Four  
 ... No. 7. 675ABC High-Voltage Power Supply and 676 Dynamic Speaker Amplifier  
 ... No. 8. 710 (Sargent-Rayment Seven) Receiver  
 ... No. 9. 678PD Phonograph Amplifier  
 .....Name  
 .....Address

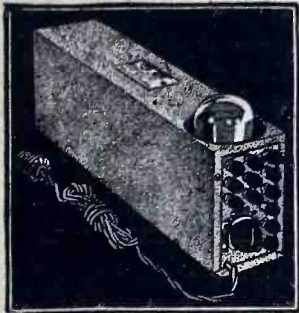
SEVERAL of our cooperating distributors, whose announcements directly follow, join us in presenting a descriptive summary of some of the outstanding receiver and amplifier values to be found in the new S-M line.

**SILVER-MARSHALL, Inc.**  
 866 West Jackson Blvd., Chicago, U. S. A.



**SM**

## Super Power for Any Set at Moderate Cost



Consider well the power-tube equipment in any set you build. Progress is fast approaching the point where a radio receiver, to be strictly modern, must be capable of delivering to a dynamic speaker the full 4500 watts of undistorted output

which represent the capacity of a 250-type power tube (as compared with 700 watts available from a 171-type).

Do you realize that, with the advent of the S-M 675ABC High-Voltage Power Supply, it is no longer either troublesome or expensive to provide this super-power in a receiver? **NO CHANGE IN RECEIVER WIRING IS REQUIRED**; an adapter is merely inserted in its detector socket.

The 675ABC, mounted in its crackle-finish case only  $3\frac{3}{16}$ " thick, is ideal for use either inside or outside of a table-type cabinet or console. Using a 281-type rectifier tube, it supplies B power at 450 volts, with taps at 135, 90, 22, and (variable) 22-90. Plenty of filament current (AC) is available at 1.5, 2.25, and 7.5 volts. The price is only \$54.00 for the complete kit, or \$58.00 wired.

Setbuilders who require only 180 volts maximum will find equal reliability in the S-M 670ABC (kit \$43.00, wired \$46.00) or the 670B (kit \$40.50, wired \$43.50).

## You Can Give S-M Tone Quality to Any Set with S-M Clough Audios



S-M Clough-system audio transformers are guaranteed unconditionally to give better tone quality than others, with *higher amplification*, regardless of size, weight, or price. They sell in tremendous quantities, by the sheer force of their superior merit, as shown by the *comparison amplifiers* used in S-M demonstrations at recent radio shows. They are made in two sizes: S-M 225, 1st stage, and 226, last stage, are \$9.00 each; S-M 255, 1st stage, and 256, last stage, are \$6.00 each.

**DEALERS and SETBUILDERS:** We are the largest S-M New England Distributor, and carry a complete S-M stock including the 730 Round-the-World Short-Wave Kits, and the 710 Sargent-Rayment. Send the coupon for maximum discounts and literature—or send your order to be shipped C. O. D. at the very best trade discount.

## H. JAPPE COMPANY

46 Cornhill

Boston, Mass.

H. JAPPE COMPANY,  
46 Cornhill, Boston, Mass.

Please send your literature and best discounts on all S-M parts, kits and power equipment, as well as all other standard radio supplies, as advertised in Radio Listeners' Guide for December

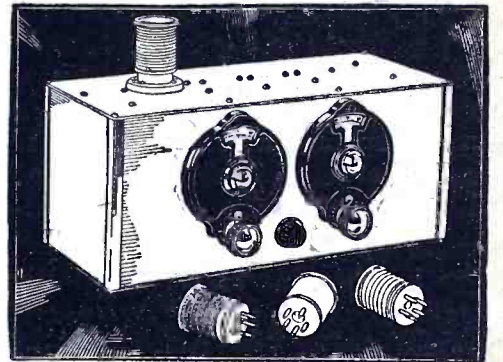
Name.....

Address.....

**SM**

## Setbuilders Supply for Quick Service!

## Hear London's Big Ben Chime in Your Home!



**NOT** with any ordinary radio receiver, of course—the Atlantic is too wide for regular broadcast receivers to bring you London programs. But an S-M "Round-the-World" short-wave set will do just that—quite regularly. Turn yours on, some night. Don't be surprised if the language you hear is a foreign one, or if the announcer mentions "Paris" or "Amsterdam," or "London" instead of the cities you are accustomed to hear from. Call your neighbors to listen if you want to—but be cautious about calling anyone who has already explored the mysterious short-wave channels with an S-M set—your wonders might sound very tame to him. Perhaps by this time he is only interested in New Zealand and Japan! For in short-waves *almost anything is possible*; amazing feats of distant reception are a matter of common knowledge.

S-M 730 "Round-the-World" complete 4-tube set, with aluminum cabinet; factory-wired, \$66, or in kit form \$51.

S-M 731 "Round-the-World" 2-tube adapter with same cabinet (converts any broadcast-band set for short-waves) also comes factory-wired, \$46, or kit \$36.

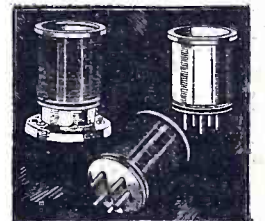
S-M 732 Essential Kit \$16.50.

### S-M 5-Prong Midget Plug-In Coils

The new S-M coils for short and broadcast waves. Wound on forms of threaded moulded bakelite.

You can use your Round-the-World Four on broadcast bands with these new coils—131X for 190-350 meters, \$1.25; 131Y for 360-650 meters, \$1.50.

Unwound coil forms, 130P plain or 130T with 98 threads, 65c. each.



**A**s national distributors of S-M Products, we carry for your convenience a complete line including the Sargent-Rayment 710, High and Medium Voltage Power Supplies, and Audio Transformers. Any of these can be shipped at once, as well as any of the other new S-M kits. Our new catalog will be a revelation to you—use the coupon and get it now!  
**LIBERAL DISCOUNTS TO THE TRADE.**

## Setbuilders Supply Co.

154 Romberg Building

Chicago

SETBUILDERS SUPPLY CO.,  
154 Romberg Bldg., Chicago, Ill.

Send me at once, **FREE**, your big new 100 Page Wholesale Catalog listing S-M and other radio parts, cabinets, consoles, and accessories of highest quality.

Name.....

Address.....

## EARNED \$500 SPARE TIME WITH RADIO

Coplay, Pa., June 4—(RA)—During the few months that Frank J. Deutsch has been a member of the Radio Association of America, he has made over \$500 out of Radio in his spare time.

"Four super-hetrodyne sets of my own construction brought me a profit of \$60.00 each, and the other profit was from sales of supplies purchased through the Wholesale Department of the Association," he said. "The Association certainly has a great plan for ambitious men."

In a neighboring state, Werner Eichler, Rochester, N. Y., another member of the Association, has been making \$50 a week during his spare time.

They are only two of the hundreds of Radio Association members who are making money out of Radio in their spare time.

## BECOMES RADIO ENGINEER IN ONE YEAR

Toronto, Canada, May 20 — (RA) — One of the newly admitted associate members of the Institute of Radio Engineers is Claude DeGrave, a member of the engineering staff of the DeForest Company of this city. "I knew nothing about Radio and started from the ground up." Mr. DeGrave stated, "when I enrolled a year ago in the Radio Association. Its easy lessons and superb training made it possible for me to become a Radio Expert in less than a year's time. My income is now about 225% more than at the time I joined the Association."

The Institute of Radio Engineers is a well-known organization, so that Mr. DeGrave has reason to be proud of his election.

## Clerk Doubles Income In Six Months Through Radio

Chicago, Ill., May 9—Even though his membership in the Radio Association has resulted in W. E. Thon securing the managership of a Radio Department in a large Chicago store, his ambition was not satisfied. Six months later, he started his own store.

"The Radio Association has an excellent plan for the man who wants to get out of the rut and succeed," says this man who quickly rose from clerkdom to the proprietorship of a profitable radio store. "I attribute my success entirely to the Radio Association of America. Six months after I had enrolled, I had doubled my income through its help."

# 5 Easy Ways to make \$3<sup>00</sup> an hour in Your Spare Time in RADIO



EACH of these plans, developed by the Radio Association of America, is a big money-maker. Set owners everywhere want to get rid of static, to have their sets operate from the electric light socket, the tone improved, and the volume increased, and transformed into single-dial controls. Phonograph owners want their machines electrified and radiofied. If you learn to render these services, you can easily make \$3.00 an hour for your spare time, to say nothing of the money you can make installing, servicing, repairing, building radio sets, and selling supplies.

Over \$600,000,000 is being spent yearly for sets, supplies, service. You can get your share of this business and, at the same time, fit yourself for the big-pay opportunities in Radio by joining the Association.

## Join the Radio Association of America

A membership in the Association offers you the easiest way into Radio. It will enable you to earn \$3.00 an hour upwards in your spare time—train you to install, repair, and build all kinds of sets—start you in business without capital or finance an invention—train you for the \$3,000 to \$10,000 big-pay radio positions—help secure a better position at bigger pay for you. *A membership need not cost you a cent!*

The Association will give you a comprehensive, practical, and theoretical training and the benefit of our Employment Service. You earn while you learn. Our cooperative plan will make it possible for you to establish a radio store. You have the privilege of buying radio supplies at wholesale from the very first.

## ACT NOW—If you wish No-Cost Membership Plan

To a limited number of ambitious men, we will give Special Memberships that may not—need not—cost you a cent. To secure one, write today. We will send you details and also our book, "Your Opportunity in the Radio Industry." It will open your eyes to the money-making possibilities of Radio.

### MAIL THIS COUPON NOW

RADIO ASSOCIATION OF AMERICA  
Dept., RR-12, 4513 Ravenswood Ave., Chicago, Ill.  
Gentlemen: Please send me by return mail full details of your Special Membership Plan, and also copy of your book, "Your Opportunity in the Radio Industry."

Name.....

Address.....

City..... State.....

# RADIO LISTENERS' GUIDE and CALL BOOK

A Quarterly Magazine



Sidney Gernsback, Editor

W. G. Manly, Managing Editor

## RADIO BROADCAST STATIONS OF THE UNITED STATES

Indexed Alphabetically by Call Letters

Turn to page 37 for our new FREE SERVICE on Broadcast Station allocations

Radio Call Stations	Broadcast Stations, Location and Owner	Power	Wave length	Kilocycles	Time at Station	Radio Call Stations	Broadcast Stations, Location and Owner	Power	Wave length	Kilocycles	Time at Station	Radio Call Stations	Broadcast Stations, Location and Owner	Power	Wave length	Kilocycles	Time at Station	
KDKA	E. Pittsburgh, Pa.—Westinghouse Elec. & Mfg. Co.	50000	305.9	980	East.	KFCR	Santa Barbara, Cal.—Santa Barbara Brdcast. Co., 1200 Anacapa St.	100	199.9	1500	Pac.	KFIZ	Fon du Lac, Wis.—Fon du Lac Commonwealth Reporter, 22 Forest Ave.	100	211.1	1420	Cent.	
KDLR	Devils Lake, N. Dak.—Radio Elec. Co.	100	247.8	1210	Cent.	KFDM	Beaumont, Tex.—Magnolia Petroleum Co.	500	535.4	560	Cent.	KFJB	Marshalltown, Iowa—Marshalltown Electric Co., 1603 W. Main St. (Divides time with WMT)	100	249.9	1200	Cent.	
KDYL	Salt Lake City, Utah—Intermountain Brdcast. Corp., 1009 Ezra Thompson Bldg.	1000	232.4	1290	Mt.	KFDX	Shreveport, La.—First Baptist Church (Divides time with KWEA)	100	247.8	1210	Cent.	KFJF	Oklahoma City, Okla.—Nat. Radio Mfg. Co., Security Bldg.	5000	204	1470	Cent.	
KEJK	Los Angeles, Cal.—Macmillan Petroleum Co., 218 N. Larchmont Blvd. (Divides time with KFON)	500	239.9	1250	Pac.	KFDY	Brookings, S. Dak.—South Dakota State College (Divides time with KFJR-KFJM)	500	545.1	550	Cent.	KFJI	Astoria, Ore.—Liberty Theatre, Geo. Kincaid (Divides time with KFEC)	50	218.8	1370	Pac.	
KELW	Burbank, Cal.—Earl L. White, 3702 Magnolia Ave. (Divides time with KNRC)	500	384.4	780	Pac.	KFEC	Portland, Ore.—Meier & Frank Co. (Divides time with KFJI)	100	218.8	1370	Pac.	KFJM	Grand Forks, N. D.—Univ. of N. D. (Divides time with KFDY-KFYR)	500	545.1	550	Cent.	
KEX	Portland, Ore.—Western Brdcast. Co. (Divides time with KOB)	5000	254.1	1180	Pac.	KFEL	Denver, Colo.—Eugene P. O'Fallon Argonaut Hotel (Divides time with KFXF)	250	319	940	Mt.	KFJR	Portland, Ore.—Ashley C. Dixon & Son, Fifth & Stark, Lumbermen's Bldg. (Divides time with KTBR)	500	230.6	1300	Pac.	
KFAB	Lincoln, Nebr.—Nebraska Buick Auto Co. (Divides time with WBBM)	5000	389.4	770	Cent.	KFEQ	St. Joseph, Mo.—Scroggin & Co. Bank, Hotel Robidoux (Divides time with WOI)	2500	535.4	560	Cent.	KFJY	Fort Dodge, Iowa—Tunwall Radio Co., 1004 Central (Divides time with KWCR)	100	228.9	1310	Cent.	
KFAD	Phoenix, Ariz.—Elec. Equipment Co.	500	483.6	620	Mt.	KFEY	Kellogg, Ida.—Union High School	10	247.8	1210	Pac.	KFJZ	Fort Worth, Tex.—Henry C. Allison, 2121 Refugio St.	100	218.8	1370	Cent.	
KFBB	Havre, Mont.—F. A. Buttrey Co. (Uses 500 Watts Daytime) (Divides time with KGIR)	250	220.4	1360	Mt.	KFGQ	Boone, Iowa—Boone Biblical College, 924 W. Second St.	10	228.9	1310	Cent.	KFKA	Greeley, Colo.—Colorado State Teachers College (Divides time with KPof)	500	340.7	880	Mt.	
KFBK	Sacramento, Cal.—Kimball-Upson Co., 610 California St.	100	228.9	1310	Pac.	KFH	Wichita, Kans.—Rigby-Gray Hotel Co., Hotel Lassen, First & Market Sts. (Divides time with WIBW)	1000	230.6	1300	Cent.	KFKB	Milford, Kans.—J. R. Brinkley, M.D. (Limited)	5000	265.3	1130	Cent.	
KFBL	Everett, Wash.—Leese Bros., 2814 Rucker Ave. (Divides time with KVL)	50	218.8	1370	Pac.	KFHA	Gunnison, Colo.—Western State College of Colorado	50	249.9	1200	Mt.	KFKU	Lawrence, Kans.—Univ. of Kans. (Divides time with WREN)	1000	245.8	1220	Cent.	
KFBU	Laramie, Wyo.—St. Mathews Cathedral, Bishop N. S. Thomas	500	499.7	600	Mt.	KFI	Los Angeles, Cal.—Earle C. Anthony, Inc., 1000 So. Hope St.	5000	468.5	640	Pac.	KFKX	Chicago, Ill.—Westinghouse Elec. & Mfg. Co., 508 Michigan Ave. (Consolidated with KYW)	5000	293.9	1020	Cent.	
KFCB	Phoenix, Ariz.—Nielson Radio & Sporting Goods Co., Central Ave. at Pierce	100	228.9	1310	Mt.	KFIF	Portland, Ore.—Benson Polytechnic School	50	211.1	1420	Pac.							
						KFIO	Spokane, Wash.—North Central High School (Daytime only)	100	243.8	1230	Pac.							

Radio Call Stations	Broadcast Stations, Location and Owner	Power	Wave length	Kilocycles	Time at Station	Radio Call Stations	Broadcast Stations, Location and Owner	Power	Wave length	Kilocycles	Time at Station	Radio Call Stations	Broadcast Stations, Location and Owner	Power	Wave length	Kilocycles	Time at Station
KFKZ	Kirksville, Mo.—State Teachers Coll.	50	249.9	1200	Cent.	KFUL	Galveston, Tex.—Will H. Ford, 2126 Market St. (Divides time with KTSA)	500	232.4	1290	Cent.	KFXY	Flagstaff, Ariz.—Mary M. Costigan, Orpheum Theatre	100	211.1	1420	Mt.
KFLV	Rockford, Ill.—Swedish Evan. Mission Church (Divides time with WHDI-WDGY-WHBL)	500	212.6	1410	Cent.	KFUM	Colorado Springs, Colo.—Corley Mountain Highway, Mining Exchange Bldg.	1000	236.1	1270	Mt.	KFYO	Breckenridge, Tex.—Kirksey Bros. Battery, Elec. & Radio Service	100	211.1	1420	Cent.
KFLX	Galveston, Tex.—Geo. R. Clough, 3327 Avenue P	100	218.8	1370	Cent.	KFUO	St. Louis, Mo. (Trans. in Clayton)—Lutheran Church of the Mo. Synod, Concordia Theo. Sem. (Divides time with KSD)	500	545.1	550	Cent.	KFYR	Bismarck, N. Dak.—Hoskins-Meyer Inc., 200 Fourth St. (Divides time with KFDY-KFJM)	500	545.1	550	Cent.
KFMX	Northfield, Minn.—Carleton Coll. (Divides time with WCAL-WRHM-WLB)	1000	239.9	1250	Cent.	KFUP	Denver, Colo.—Fitzsimons Gen. Hosp., Red Cross Bldg., Educational and Recreational Dept., U. S. Army (Divides time with KFXJ)	100	228.9	1310	Mt.	KGA	Spokane, Wash.—Northwest Radio Serv. Co., 325 E. Rowan Ave.	5000	204	1470	Pac.
KFNF	Shenandoah, Iowa—Henry Field Seed & Nursery Co. (Divides time with WNAX-KSUD)	500	336.9	890	Cent.	KFUR	Ogden, Utah (Trans. in Farmington)—Peery Bldg. Co., 420 Twenty-fifth St.	50	218.8	1370	Pac.	KGAR	Tucson, Ariz.—Tucson Citizen, 80 South Stone St.	100	218.8	1370	Mt.
KFOA	Seattle, Wash.—Rhodes Dept. Store (Divides time with KTW)	1000	236.1	1260	Pac.	KFVD	Venice, Cal.—(Trans. in Culver City)—McWhinnie Elec. Co., 1825 So. Pacific Ave. (Limited time)	250	428.3	700	Pac.	KGB	San Diego, Cal.—So. Western Brdcast. Corp., Electric Bldg.	250	220.4	1360	Pac.
KFON	Long Beach, Cal.—Nichols & Wariner, Inc., Jergins Trust Bldg. (Divides time with KEJK)	1000	239.9	1250	Pac.	KFVS	Cape Girardeau, Mo.—Hirsch Battery & Radio Co., 312 S. Frederick St. (Divides time with WEBQ)	100	247.8	1210	Cent.	KGBX	St. Joseph, Mo.—Foster-Hall Tire Co., 1221 Fred. Ave. (Divides time with KWKC)	100	218.8	1370	Cent.
KFOR	Lincoln, Nebr.—Howard A. Shuman	100	247.8	1210	Cent.	KFWB	Los Angeles, Cal.—Warner Bros. Pictures, Inc., 5842 Sunset Blvd. (Divides time with KPSN)	1000	315.6	950	Pac.	KGBY	Shelby, Nebr.—(Trans. in Columbus)—Dunning & Taddiken (Cons. with KGBZ)	500	322.4	930	Cent.
KFPL	Dublin, Tex.—C. C. Baxter, 205 Grafton St.	15	228.9	1310	Cent.	KFWC	San Bernardino, Cal. (Trans. in Ontario)—L. E. Wall (Valley Blvd.) (Divides time with KPPC)	100	249.9	1200	Pac.	KGBZ	York, Nebr.—Fed. Live Stock Rem. Co., 715 Grand Ave. (Divides time with KMA)	500	322.4	930	Cent.
KFPM	Greenville, Tex.—The New Furniture Co.	15	228.9	1310	Cent.	KFWF	St. Louis, Mo.—St. Louis Truth Center, 4030 Lindell Blvd. (Divides time with WMAV)	100	249.9	1200	Cent.	KGCA	Decorah, Iowa—Chas. W. Greenley (Divides time with KWLC) (Daytime only)	50	236.1	1270	Cent.
KFPW	Sulphur Springs, Ark. (Trans. in Siloam Spgs.)—St. John's M. E. Church, 120 W. Main St. (Daytime only)	50	223.7	1340	Cent.	KFWI	San Francisco, Cal. (Trans. in So. San Francisco), Radio Entertainments, Inc., 1182 Market St. (Divides time with KFWM)	500	322.4	930	Pac.	KGCB	Oklahoma City, Okla.—Wallace Radio Inst., 103 W. 13th St. (Divides time with KGFG)	100	218.8	1370	Cent.
KFPY	Spokane, Wash.—Symons Inv. Co. (Divides time with KWSC)	500	215.7	1390	Pac.	KFWO	Avalon, Catalina Island, Cal.—Major Lawrence Mott, Signal Corps, U. S. Army (Divides time with KWTC)	100	199.9	1500	Pac.	KGCH	Wayne, Nebr.—Farmers & Merchants Cooperative Radio Corp. of America (Consol. with KGBZ)	500	322.4	930	Cent.
KFQA	St. Louis, Mo.—Voice of St. Louis, Inc.	5000	275.1	1090	Cent.	KFXD	Jerome, Ida.—The Service Radio Co., Main St.	15	211.1	1420	Mt.	KGCI	San Antonio, Tex.—Liberto Radio Sales, 409 S. Flores St. (Divides time with KGRC)	100	218.8	1370	Cent.
KFOB	Ft. Worth, Tex.—W. B. Fishborn, Inc., 205 Worth Bldg. (Divides time with WJAD)	1000	241.8	1240	Cent.	KFXE	Denver, Colo.—Pikes Peak Brdcast. Co., Brown Palace Hotel (Divides time with KFEL)	250	319	940	Mt.	KGCN	Concordia, Kans.—Concordia Brdcast. Co., 105 E. 5th St.	50	211.1	1420	Cent.
KFQU	Holy City, Cal.—W. E. Riker (Divides time with KGTT)	100	211.1	1420	Pac.	KFXF	Edgewater, Colo.—R. G. Howell (Divides time with KFUP)	50	228.9	1310	Mt.	KGCR	Brookings, S. Dak.—Cutler's Radio Brdcast. Serv., Inc., 415 Main St.	100	247.8	1210	Cent.
KFQW	Seattle, Wash.—KFQW Inc., Continental Hotel (Divides time with KKP)	100	211.1	1420	Pac.	KFXR	Oklahoma City, Okla.—Exchange Ave. Baptist Church, 416 W. Grand St.	100	228.9	1310	Cent.	KGCU	Mandan, N. Dak.—Mandan Radio Assn., 320 Main St.	100	249.9	1200	Mt.
KFQZ	Hollywood, Cal.—Taft Radio & Brdcast. Co., Inc., 1641 N. Argyre (Limited time)	1000	352.7	850	Pac.							KGCX	Vida, Mont.—First State Bank of Vida	10	211.1	1420	Mt.
KFRC	San Francisco, Cal.—Don Lee, Inc.	1000	491.5	610	Pac.							KGDA	Dell Rapids, S. Dak.—Home Auto Co.	15	218.8	1370	Cent.
KFRU	Columbia, Mo.—Stephens College, Administration Bldg. (Divides time with WOS-WGBF)	500	475.9	630	Cent.							KGDE	Barrett, Minn.—Jaren Drug Co.	50	249.9	1200	Cent.
KFSD	San Diego, Cal.—Airfan Radio Corp., U. S. Grant Hotel (1000 Watts Daytime)	500	499.7	600	Pac.							KGDM	Stockton, Cal.—E. F. Peffer, 42 S. California St. (Daytime)	50	260.7	1150	Pac.
KFSG	Los Angeles, Cal.—Echo Park Evan. Assn., Angelus Temple (Divides time with KMIC)	500	267.7	1120	Pac.							KGDP	Pueblo, Colo.—Pueblo Council, Boy Scouts of Amer.	10	247.8	1210	Mt.

Radio Call Stations	Broadcast Stations, Location and Owner	Power	Wave length	Kilocycles	Time at Station	Radio Call Stations	Broadcast Stations, Location and Owner	Power	Wave length	Kilocycles	Time at Station	Radio Call Stations	Broadcast Stations, Location and Owner	Power	Wave length	Kilocycles	Time at Station
<b>KGDR</b>	San Antonio, Tex.—Joe B. McShane	100	199.9	1500	Cent.	<b>KGHA</b>	Pueblo, Colo.—Geo. H. Sweeney and N. S. Walpole	50	249.9	1200	Pac.	<b>KICK</b>	Atlantic, Iowa (Trans. in Red Oak)—Red Oak Radio Corp. (Divides time with WIAS)	100	211.1	1420	Cent.
<b>KGDW</b>	Humboldt, Nebr.—Frank J. Rist (Cons. with KGBZ)	500	322.4	930	Cent.	<b>KGHD</b>	Missoula, Mont.—Elmore-Nash Brcast. Corp., 542 S. Third St. West	5	211.1	1420	Mt.	<b>KIDO</b>	Boise, Ida.—Independent School, Dist. of Boise (Divides time with KDYL)	1000	243.8	1230	Mt.
<b>KGDY</b>	Oldham, S. Dak.—J. Albert Loesch	15	249.9	1200	Cent.	<b>KGHF</b>	Pueblo, Colo.—Curtis P. Ritchie and Joe E. Finch	250	227.1	1320	Mt.	<b>KJBS</b>	San Francisco, Cal.—Julius Brunton & Sons Co., 1380 Bush St. (Daytime)	100	272.6	1100	Pac.
<b>KGEF</b>	Los Angeles, Cal.—Trinity Methodist Church, 1201 So. Flower St. (Divides time with KTBI)	1000	230.6	1300	Pac.	<b>KGHG</b>	McGehee, Ark.—Charles W. McCollum	50	228.9	1310	Cent.	<b>KJR</b>	Seattle, Wash.—Northwest Radio Serv. Co., 604 Hom Sav. Bldg.	5000	309.1	970	Pac.
<b>KGEK</b>	Yuma, Colo.—Beehler Elec. Equip. Co., 109 W. Second Ave. (Divides time with KGEW)	50	249.9	1200	Mt.	<b>KGHI</b>	Little Rock, Ark.—Berean Bible Class, 1201 Louisiana St.	100	199.9	1500	Cent.	<b>KKP</b>	Seattle, Wash.—City of Seattle, Harbor Dept. (Divides time with KFQW)	15	211.1	1420	Pac.
<b>KGEO</b>	Grand Island, Nebr.—Hotel Yancey, 116 N. Locust St. (Cons. with KGBZ)	500	322.4	930	Cent.	<b>KGHL</b>	Billings, Mont.—Northwestern Auto Supply Co., Fifth Ave. & North Broadway	500	315.6	950	Mt.	<b>KLCN</b>	Blytheville, Ark.—Daily Courier News	50	232.4	1290	Cent.
<b>KGER</b>	Long Beach, Cal.—C. Merwin Dobyys, 435 Pine Ave.	100	218.8	1370	Pac.	<b>KGHX</b>	Richmond, Tex.—Fort Bend Co. School Board	50	199.9	1500	Cent.	<b>KLDS</b>	Independence, Mo.—Midland Brcast. Co. and Reor. Church of Jesus Christ of Latter Day Saints (Limited) (Divides time with WHB)	1000	315.6	950	Cent.
<b>KGES</b>	Central City, Nebr.—Central Radio Elec. Co. (Cons. with KGBZ)	500	322.4	930	Cent.	<b>KGIO</b>	Idaho Falls, Ida.—Jack W. Duckworth, Jr., 423 Tamarack Ave., Inglewood, Cal. (Divides time with KGIQ)	250	227.1	1320	Mt.	<b>KLRA</b>	Little Rock, Ark.—Arkansas Brcast. Co., 210 Center St. (Divides time with KUOA)	1000	215.7	1390	Cent.
<b>KGEW</b>	Fort Morgan, Colo.—City of Fort Morgan, City Hall Bldg. (Divides time with KGEK)	100	249.9	1200	Mt.	<b>KGIQ</b>	Twin Falls, Ida.—Stanley M. Soule, Walker Bank Bldg., Salt Lake City, Utah (Divides time with KGIO)	250	227.1	1320	Mt.	<b>KLS</b>	Oakland, Cal.—Warner Bros. Radio Supplies Co., 2201 Telegraph Ave. (Divides time with KWG) (250 watts daytime)	100	208.2	1440	Pac.
<b>KGEZ</b>	Kalispell, Mont.—Flathead Brcast. Assn.	100	228.9	1310	Mt.	<b>KGIR</b>	Butte, Mont.—Symons Brcast. Co., 200 E. Broadway (Divides time with KFBB)	250	220.4	1360	Mt.	<b>KLX</b>	Oakland, Cal.—The Oakland Tribune	500	340.7	880	Pac.
<b>KGFF</b>	Alva, Okla.—Earl E. Hampshire, 718 5th St.	100	211.1	1420	Cent.	<b>KGJF</b>	Little Rock, Ark.—First Church of the Nazarene	250	336.9	890	Cent.	<b>KLZ</b>	Denver, Colo. (Trans. in Dupont)—Reynolds Radio Co., Shirley Savoy Hotel	1000	535.4	560	Mt.
<b>KGFG</b>	Oklahoma City, Okla.—Full Gospel Church (Divides time with KGCB)	50	218.8	1370	Cent.	<b>KGKB</b>	Goldthwaite, Tex.—Eagle Pub. Co.	100	199.9	1500	Cent.	<b>KMA</b>	Shenandoah, Iowa—May Seed & Nursery Co. (Divides time with KGBZ)	500	322.4	930	Cent.
<b>KGFH</b>	La Crescenta, Cal. (Trans. in Glendale)—Frederick Robinson, Box 163 (Limited)	250	299.8	1000	Pac.	<b>KGKL</b>	Georgetown, Tex.—M. L. Cates, 1263 Brushy St.	100	218.8	1370	Cent.	<b>KMBC</b>	Kansas City, Mo.—Midland Brcast. Co. (Limited) (Divides time with WHB)	500	315.6	950	Cent.
<b>KGFI</b>	San Angelo, Tex.—San Angelo Brcast. Co.	100	228.9	1310	Cent.	<b>KGKO</b>	Wichita Falls, Tex.—Highland Hts. Christian Church, 2146 Avenue H	250	526	570	Cent.	<b>KMED</b>	Medford, Ore.—W. J. Virgin	50	211.1	1420	Pac.
<b>KGFI</b>	San Angelo, Tex.—San Angelo Brcast. Co.	100	228.9	1310	Cent.	<b>KGO</b>	Oakland, Cal.—General Electric Co.	10000	379.5	790	Pac.	<b>KMIC</b>	Inglewood, Cal.—J. R. Fouch, 219 N. Market St. (Divides time with KFSG)	500	267.7	1120	Pac.
<b>KGFI</b>	San Angelo, Tex.—San Angelo Brcast. Co.	100	228.9	1310	Cent.	<b>KGRC</b>	San Antonio, Tex.—Paramount Radio Co., 103 San Pedro Ave.	100	218.8	1370	Cent.	<b>KMJ</b>	Fresno, Cal.—Fresno Bee	100	249.9	1200	Pac.
<b>KGFI</b>	San Angelo, Tex.—San Angelo Brcast. Co.	100	228.9	1310	Cent.	<b>KGRS</b>	Amarillo, Tex.—Gish Radio Service, 108 E. 8th St. (Divides time with WDAG)	1000	212.6	1410	Cent.	<b>KMMJ</b>	Clay Center, Nebr.—M. M. Johnson Co. (Limited time)	1000	405.2	740	Cent.
<b>KGFI</b>	San Angelo, Tex.—San Angelo Brcast. Co.	100	228.9	1310	Cent.	<b>KGTT</b>	San Francisco, Cal.—Glad Tidings Temple & Bible Inst. (Divides time with KFQU)	50	211.1	1420	Pac.	<b>KMO</b>	Tacoma, Wash.—KMO, Inc., Hotel Winthrop (Divides time with KVI)	500	223.7	1340	Pac.
<b>KGFI</b>	San Angelo, Tex.—San Angelo Brcast. Co.	100	228.9	1310	Cent.	<b>KGW</b>	Portland, Ore.—The Oregonian Pub. Co., 806 Oregonian Bldg.	1000	483.6	620	Pac.	<b>KMOX</b>	St. Louis, Mo. (Trans. in Kirkwood)—The Voice of St. Louis, Inc., Mayfair Hotel	5000	275.1	1090	Cent.
<b>KGFI</b>	San Angelo, Tex.—San Angelo Brcast. Co.	100	228.9	1310	Cent.	<b>KGY</b>	Lacey, Wash.—St. Martins College (Divides time with KKP-KFQV) (10 watts at night)	50	249.9	1200	Pac.	<b>KMTR</b>	Hollywood, Cal.—KMTR Radio Corp., 1025 N. Highland Ave. (Divides time with KPLA)	1000	526	570	Pac.
<b>KGFI</b>	San Angelo, Tex.—San Angelo Brcast. Co.	100	228.9	1310	Cent.	<b>KHJ</b>	Los Angeles, Cal.—Don Lee, Inc.	1000	333.1	900	Pac.						
<b>KGFI</b>	San Angelo, Tex.—San Angelo Brcast. Co.	100	228.9	1310	Cent.	<b>KHQ</b>	Spokane, Wash.—Louis Wasmer, Dav- enport Hotel	1000	508.2	590	Pac.						



Radio Call Stations	Broadcast Stations, Location and Owner	Power	Wave length	Kilocycles	Time at Station	Radio Call Stations	Broadcast Stations, Location and Owner	Power	Wave length	Kilocycles	Time at Station	Radio Call Stations	Broadcast Stations, Location and Owner	Power	Wave length	Kilocycles	Time at Station
<b>KWKC</b>	Kansas City, Mo.—Wilson Duncan Brcdcast. Studios, Werby Bldg. (Divides time with KGBX)	100	218.8	1370	Cent.	<b>WABF</b>	Kingston, Pa.—Markle Broadcasting Corp., 294 Wyoming Ave. (Divides time with WRAX)	250	208.2	1440	East.	<b>WBBL</b>	Richmond, Va.—Grace-Convent Presbyterian Church, 1627 Monument Ave.	100	218.8	1370	East.
<b>KWKH</b>	Shreveport, La. (Trans. in Kennonwood)—W. K. Henderson (Divides time with WWL)	20000	352.7	850	Cent.	<b>WABI</b>	Bangor, Me.—First Univers. Church, Park St.	100	249.9	1200	East.	<b>WBBM</b>	Chicago, Ill. (Trans. in Glenview)—Atlas Invest. Co., 728 Kimball Bldg. (Divides time with KFAB)	25000	389.4	770	Cent.
<b>KWLC</b>	Decorah, Iowa—Luther College (Divides time with KGCA)	50	236.1	1270	Cent.	<b>WABO</b>	Rochester, N. Y.—Hickson Elec. Co. (Divides time with WMAC-WOKO)	500	208.2	1440	East.	<b>WBBR</b>	Rossville, N. Y.—PeoplesPulpitAssn. 117 Adams St., Bklyn. (Divides time with WHAP-WEVD-WHAZ)	1000	230.6	1300	East.
<b>KWSC</b>	Pullman, Wash.—State Coll. of Wash., Mech. Arts Bldg. (Divides time with KFPY)	500	215.7	1390	Pac.	<b>WABY</b>	Philadelphia, Pa.—John Magaldi, Jr. (Divides time with WFKD-WNAT)	50	228.9	1310	East.	<b>WBBW</b>	Norfolk, Va.—Ruffner Jr. High Sch.	100	249.9	1200	East.
<b>KWTC</b>	Santa Ana, Cal.—Pac. Brcdcast. Fed., 1101 N. Rose St. (Divides time with KFWO)	100	199.9	1500	Pac.	<b>WABZ</b>	New Orleans, La.—Colis. Place Bapt. Church, 1376 Camp St. (Divides time with WJBW)	100	249.9	1200	Cent.	<b>WBBY</b>	Charleston, S. Car.—Wash. Lt. Inf.	75	249.9	1200	East.
<b>KWWG</b>	Brownsville, Tex.—Cham. of Com. (Divides time with KRGV)	500	238	1260	Cent.	<b>WADC</b>	Akron, Ohio—Allen T. Simmons, Towell - Cadillac Bldg. (Divides time with WFJC)	1000	227.1	1320	East.	<b>WBBZ</b>	Ponca City, Okla.—C. L. Carrell, 1506 No. Amer. Bldg.	100	249.9	1200	Cent.
<b>KXA</b>	Seattle, Wash.—Amer. Radio Tel. Co. (Divides time with KUOM)	500	526	570	Pac.	<b>WAFD</b>	Detroit, Mich.—Albert B. Parfet Co., Charlotte St. & Woodward Ave. (Divides time with WMBC)	100	199.9	1500	East.	<b>WBCN</b>	Chicago, Ill.—Great Lakes Brcdcast. Co., Straus Bldg. (Divides time with WLS)	5000	344.6	870	Cent.
<b>KXL</b>	Portland, Ore.—KXL Brcdcasters, 719 Bedell Bldg. (Divides time with KFAU)	500	239.9	1250	Pac.	<b>WAGM</b>	Royal Oak, Mich.—Robt. L. Miller, 309 So. Main St. (Divides time with WBMH)	50	228.9	1310	East.	<b>WBET</b>	Boston, Mass. (Trans. at Needford)—Boston Transcript (Divides time with WMAF)	500	220.4	1360	East.
<b>KXO</b>	El Centro, Cal.—E. R. Irely & F. M. Bowels, Cham. of Com. Bldg.	15	249.9	1200	Pac.	<b>WAIU</b>	Columbus, Ohio—Deshler-Malleck Hotel, Am. Ins. Union (Limited time)	5000	468.5	640	East.	<b>WBIS</b>	Boston, Mass.—The Shepard Stores	500	243.8	1230	East.
<b>KXRO</b>	Aberdeen Wash.—KXRO, Inc., Heron & South H Sts.	75	211.1	1420	Pac.	<b>WALK</b>	Willow Grove, Pa.—Albert A. Walker, (Divides time with WHBW-WOO-WPSW)	50	199.9	1500	East.	<b>WBMH</b>	Detroit, Mich.—Braun's Music House, 13214 E. Jefferson Ave. (Divides time with WAGM)	100	228.9	1310	Cent.
<b>KYA</b>	San Francisco, Cal.—Pac. Brcdcast. Co.	1000	243.8	1230	Pac.	<b>WAPI</b>	Auburn, Ala.—Ala. Poly. Inst. (Divides time with KVOO)	5000	263	1140	Cent.	<b>WBMS</b>	Union City, N. J.—WBMS Brcdcast. Corp., 837-34th St. (Divides time with WNJ-WIBS-WKBO)	250	206.8	1450	East.
<b>KYW</b>	Chicago, Ill.—West. Elec. & Mfg. Co. 508 S. Michigan Ave. (Cons. with KFKX)	5000	293.9	1020	Cent.	<b>WASH</b>	Grand Rapids, Mich.—Baxter Laundries, Inc. (Divides time with WOOD)	250	236.1	1270	East.	<b>WBNY</b>	New York, N. Y.—Baruchrome Corp., 400 E. 139th St. (Divides time with WMSG-WCDA-WKBQ)	250	222.1	1350	East.
<b>KZM</b>	Oakland, Cal. (Trans. in Hayward)—Leon P. Tenney, 13th & Harrison Sts. (Divides time with KRE)	100	218.8	1370	Pac.	<b>WBAA</b>	West Lafayette, Ind.—Purdue Univ. (Divides time with WCMA-WKBF)	500	214.2	1400	Cent.	<b>WBOQ</b>	New York, N. Y. (Trans. in Richmond Hill)—Atlantic Brcdcast. Corp., 113 W. 57th St., N. Y. C. (Cons. with WABC)	5000	348.6	860	East.
<b>NAA</b>	Arlington, Va.—United States Navy	1000	434.5	690	East.	<b>WBAK</b>	Harrisburg, Pa.—Penn. State Police (Daytime only)	500	267.7	1120	East.	<b>WBOW</b>	Terre Haute, Ind.—Banks of Wabash Brcdcast. Assn.	100	228.9	1310	Cent.
<b>WAAD</b>	Cincinnati, Ohio—Ohio Mech. Inst. (Divides time with WSRO)	25	211.1	1420	East.	<b>WBAL</b>	Baltimore, Md. (Trans. in Glen Morris)—Cons. Gas, Elec. Lt. & Power Co. (Divides time with WTIC)	10000	282.8	1060	East.	<b>WBRC</b>	Birmingham, Ala.—Birm. Brcdcast. Corp., Loew's Temple Theatre	500	322.4	930	Cent.
<b>WAAF</b>	Chicago, Ill.—Chicago Daily Drivers Journal (Daytime only)	500	325.9	920	Cent.	<b>WBAP</b>	Fort Worth, Tex.—Carter Pub. Co., Inc. (Divides time with KTHS)	5000	374.8	800	Cent.	<b>WBRE</b>	Wilkes-Barre, Pa.—L. G. Baltimore, 16 N. Main St.	100	228.9	1310	East.
<b>WAAM</b>	Newark, N. J.—I. R. Nelson, 1 Bond St., Studio, 626 Central Ave., E. Orange (Divides time with WODA-WGCP)	500	239.9	1250	East.	<b>WBAW</b>	Nashville, Tenn.—Waldrum Drug Co. (Divides time with WLAC)	5000	201.2	1490	Cent.	<b>WBRL</b>	Tilton, N. H.—Booth Radio Lab., 23 Summer St. (Divides time with WICC)	500	209.7	1430	East.
<b>WAAT</b>	Jersey City, N. J.—Bremer Brcdcast. Corp., 210 Jackson Ave.	300	280.2	1070	East.	<b>WBAX</b>	Wilkes-Barre, Pa.—John H. Stenger, Jr., 66 Gildersleeve St. (Divides time with WJBW)	100	247.8	1210	East.	<b>WBSO</b>	Wellesley Hills, Mass. (Trans. in Babson Park)—Babson Statistical Organization (Daytime only)	100	384.4	780	East.
<b>WAAW</b>	Omaha, Nebr.—Omaha Grain Exch. (Daytime only)	500	454.3	660	Cent.	<b>WBBC</b>	Brooklyn, N. Y.—Brooklyn Brcdcast. Corp., 16 Court St. (Divides time with WSDA-WCGU-WLTH-WSGH)	500	214.2	1400	East.	<b>WBT</b>	Charlotte, N. C.—C. C. Coddington, 500 W. Trade St.	10000	277.8	1080	East.
<b>WABC</b>	New York, N. Y.—Atl. Brcdcast. Corp., 113 W. 57th St. (Cons. with WBOQ)	5000	348.6	860	East.							<b>WBZ</b>	Springfield, Mass. (Trans. in East. Spgfield)—West. Elec. & Mfg. Co., Hotel Kimball (Divides time with WBZA)	15000	302.8	990	East.





Radio Call Stations	Broadcast Stations, Location and Owner	Power	Wave length	Kilocycles	Time at Station	Radio Call Stations	Broadcast Stations, Location and Owner	Power	Wave length	Kilocycles	Time at Station	Radio Call Stations	Broadcast Stations, Location and Owner	Power	Wave length	Kilocycles	Time at Station
WEBW	Beloit, Wis.— Beloit College (Daytime only)	250	499.7	600	Cent.	WFCI	Pawtucket, R. I.— Frank Crook, Inc., 103 Exchange St. (Divides time with WDFW-WLSI)	100	247.8	1210	East.	WGN	Chicago, Ill.— The Chicago Tribune, Drake Hotel	25000	416.4	720	Cent.
WEDC	Chicago, Ill.— —Emil Denmark Brdcast. Sta., 3860 Ogden Ave. (Divides time with WCRW-WSBC)	100	247.8	1210	Cent.	WFDF	Flint, Mich.— Frank D. Fallin, 513 So. Saginaw St.	100	228.9	1310	East.	WGR	Buffalo, N. Y.— Federal Radio Corp., Hotel Statler (Divides time with WSYR)	750	545.1	550	East.
WEDH	Erie, Pa.—Erie Dispatch-Herald	30	211.1	1420	East.	WFI	Philadelphia, Pa.— Strawbridge & Clothier (Divides time with WLIT)	500	535.4	560	East.	WGST	Atlanta, Ga.— Georgia Sch. of Tech. (Divides time with WMAZ)	500	336.9	890	Cent.
WEEL	Boston, Mass.— The Edison Elec. Illuminating Co.	500	508.2	590	East.	WFIW	Hopkinsville, Ky.— Acme Mills, Inc.	1000	319	940	Cent.	WGY	Schenectady, N. Y.— Gen. Elec. Co. (Limited)	50000	379.5	790	East.
WEHS	Evanston, Ill.— —A. T. Becker, 1318 Elmwood Ave. (Divides time with WHFC-WCLS-WKBB-WKBI)	100	228.9	1310	Cent.	WFJC	Akron, Ohio— W. F. Jones Brdcast. Inc. (Divides time with WJAY)	500	206.8	1450	East.	WHA	Madison, Wis.— Univ. of Wis. (Divides timewith WPCC-WRM)	750	570	526	Cent.
WEMC	Berrien Springs, Mich.— Emmanuel Missionary (Daytime only)	1000	508.2	590	Cent.	WFKD	Philadelphia, Pa.— Foulkrod Radio Engin. Co. (Divides with WNAT-WABY)	50	228.9	1310	East.	WHAD	Milwaukee, Wis.— Marquette Univ. (Divides time with WISN)	250	267.7	1120	Cent.
WENR	Chicago, Ill.— Great Lakes Radio Brdcast. Co., 310 S. Michigan Ave. (Cons. with WBCN) (Divides time with WLS)	5000	344.6	870	Cent.	WFLA	Clearwater, Fla. (Trans. in City Park at Causeway)— Chamber of Commerce	1000	333.1	900	East.	WHAM	Rochester, N. Y. (Trans. in Victor Tnshp.)— Stromberg-Carlson Tel. Mfg. Co.	5000	260.7	1150	East.
WEPS	Gloucester, Mass.— Matheson Radio Co., 209 Main St. (Divides time with WKBE)	100	249.9	1200	East.	WGAL	Lancaster, Pa.— Lancaster Elec. Supply & Const. Co., 23 E. Orange St. (Divides time with WRAW)	15	228.9	1310	East.	WHAP	New York, N. Y. (Trans. in Carlstadt, N. J.)— Defenders of Truth Soc., Inc., 9 W. 96th St. (Divides time with WBBR-WEVD-WHAZ)	500	230.6	1300	East.
WEVD	New York, N. Y. (Trans. in Woodhaven)— Union Course Labs. Debs Memorial Radio Fund (Divides time with WBBR-WHAP-WHAZ)	500	230.6	1300	East.	WGBB	Freeport, N. Y.— Harry H. Carman, 217 Bedell St. (Divides time with WJBI-WINR-WCOH)	100	247.8	1210	East.	WHAS	Louisville, Ky.— Cour.-Jl. and Louisville Times, 3rd & Liberty Sts.	5000	365.6	820	Cent.
WEW	St. Louis, Mo.— St. Louis Univ. (Daytime only)	1000	394.5	760	Cent.	WGBC	Memphis, Tenn.— First Baptist Church, Linden & Lauderdale Sts. (Divides time with WNBR)	500	209.7	1430	Cent.	WHAZ	Troy, N. Y.— Rehsselaer Poly. Inst. (Divides time with WBBR-WHAP-WEVD)	500	230.6	1300	East.
WFAA	Dallas, Tex.— Dallas News and Sears, Roebuck & Co., Baker Hotel (Divides time with KRLD)	5000	288.3	1040	Cent.	WGBF	Evansville, Ind.— Evansville on the Air, Inc. (Divides time with WOS-KFRU)	500	475.9	630	Cent.	WHB	Kansas City, Mo.— Sweeney Automotive & Elec. School, Sweeney Bldg. (Divides time with KLDS-KMBC)	500	315.6	950	Cent.
WFAN	Philadelphia, Pa.— Keystone Brdcast. Co., Hotel Lorraine (Divides time with WIP)	500	491.5	610	East.	WGBI	Scranton, Pa.— Scranton Broadcasters, Inc., 318 Adams Ave. (Divides time with WQAN)	250	340.7	880	East.	WHBC	Canton, Ohio— St. John's Cath. Ch., 627 McKinley Ave., N. W.	10	249.9	1200	East.
WFBC	Knoxville, Tenn.— First Baptist Church	50	249.9	1200	Cent.	WGBS	New York, N. Y.— (Trans. in Astoria, L. I.)— Gimbel Bros., 33rd St. & Bway. (Limited time)	500	254.1	1180	East.	WHBD	Bellefontaine, Ohio— First Presbyterian Church	100	218.8	1370	East.
WFBE	Cincinnati, Ohio— Park View Hotel	100	249.9	200	East.	WGCM	Gulfport, Miss.— Gulf Coast Music Co., 1319-26th Ave.	100	247.8	1210	Cent.	WHBF	Rock Island, Ill.— Beardsley Specialty Co., 217-18th St.	100	247.8	1210	Cent.
WFBG	Altoona, Pa.— The Wm. F. Gable Co. (Divides time with WHBP)	100	228.9	1310	East.	WGCP	Newark, N. J.— Paramount Brdcast. & Artists' Serv., 591 Broad St. (Divides time with WODA-WAAM)	500	239.9	1250	East.	WHBL	Sheboygan, Wis.— Press Pub. Co., C. L. Carrell, 1506 No. Amer. Bldg. (Divides time with KFLV-WDGY-WHDI)	500	212.6	1410	Cent.
WFBJ	Collegeville, Minn.— St. John's University	100	218.8	1370	Cent.	WGES	Chicago, Ill.— (Trans. in Oak Park)— Oakleaves Broadcasting Corp., 128 N. Crawford Ave. (Divides time with WJKS)	500	220.4	1360	Cent.	WHBP	Johnstown, Pa.— Johnstown Automobile Co., 101 Main St. (Divides time with WFBG)	100	228.9	1310	East.
WFBL	Syracuse, N. Y.— The Onondaga Co. (Divides time with WMAK)	750	333.1	900	East.	WGHP	Mt. Clemens, Mich.— (Trans. in Fraser), —Geo. H. Phelps, Studio 1408 Maccabee Bldg., Detroit.	750	241.8	1240	East.	WHBQ	Memphis, Tenn.— WHBQ, Inc., Dermon Bldg.	100	218.8	1370	Cent.
WFBM	Indianapolis, Ind.— (Trans. in Perry Tnshp.)— Indianapolis Power & Lt. Co. (Divides time with WSBT-WCWK) (Limited)	25000	243.8	1230	Cent.	WGMS	St. Paul-Minneapolis, Minn.— Washburn-Crosby Co. (Divides time with W C A L - K F M X - WRHM)	1000	239.9	1250	Cent.	WHBU	Anderson, Ind.— Citizens Bank, 1101 Meridian St.	100	247.8	1210	Cent.
WFBR	Baltimore, Md.— Balt. Radio Show, Inc., Hoffman & Bolton Sts.	250	267.7	1120	East.							WHBW	Philadelphia, Pa.— D. R. Kienzle, 4916 Chestnut St. (Divides time with WPSW-WALK-WOO)	100	199.9	1500	East.
												WHBY	West De Pere, Wis.— St. Norbert's College	50	249.9	1200	Cent.

Radio Call Stations	Broadcast Stations, Location and Owner	Power	Wave length	Kilocycles	Time at Station	Radio Call Stations	Broadcast Stations, Location and Owner	Power	Wave length	Kilocycles	Time at Station	Radio Call Stations	Broadcast Stations, Location and Owner	Power	Wave length	Kilocycles	Time at Station	
WHDI	—Minneapolis, Minn. — Wm. Hood Dunwoody Indust. Inst., 818 Superior Blvd. (Divides time with WDGY-KFLV-WHBL)	500	212.6	1410	Cent.	WIBW	—Topeka, Kans. — C. L. Carrell, 901 Natl. Reserve Life Ins. Co. Bldg. (Divides time with KFH)	1000	230.6	1300	Cent.	WJBI	—Red Bank, N. J. — Robt. S. Johnson, 63 Broad St. (Divides time with WINR - WCOH - WGGB)	100	247.8	1210	East.	
WHEC	—Rochester, N. Y. — Hickson Elec. Co., 36 South Ave. (Cons. with WABO, Lake Ave. Bapt. Ch.) (Divides time with WMAC-WOKO)	500	208.2	1440	East.	WIBX	—Utica, N. Y. — WIBX, Inc., Hotel Utica	100	249.9	1200	East.	WJBK	—Ypsilanti, Mich. Ernest F. Goodwin, 803 Congress St. (Divides time with WIBM)	50	218.8	1370	Cent.	
WHFC	—Chicago, Ill. — Goodson & Wilson, Inc., Hotel Flanders, 4145 Bway. (Divides time with WKBI - WKBB - WCLS-WEHS)	100	228.9	1310	Cent.	WIBZ	—Montgomery, Ala. — A. D. Trum, 217 Catoma St.	15	199.9	1500	Cent.	WJBL	—Decatur, Ill. — Wm. Gushard Dry Gds. Co., 301 N. Water St. (Divides time with WJBC)	100	249.9	1200	Cent.	
WHK	—Cleveland, Ohio Radlo Air Serv. Corp., 1116 Carnegie Hall	1000	215.7	1390	East.	WICC	—Bridgeport, Conn. (Trans. in Easton)—Bridgeport Brdcast. Co., Inc. (Divides time with WBRL)	500	209.7	1430	East.	WJBO	—New Orleans, La. — Valdemar Jensen, 119 S. St. Patrick St.	100	218.8	1370	Cent.	
WHN	—New York, N. Y. — Marcus Loew Bkg. Agcy., Inc. (Divides time with WQAO - WPAP-WRNY)	250	296.9	1010	East.	WIL	—St. Louis, Mo. — Missouri Brdcast. Corp.,	100	211.1	1420	Cent.	WJBT	—Chicago, Ill. — John S. Boyd, Kimball Bldg.	25000	389.4	770	Cent.	
WHO	—Des Moines, Iowa — Bnks. Life Co., 1110 Liberty Bldg. (Divides time with WOC)	5000	299.8	1000	Cent.	WILL	—Urbana, Ill. — Univ. of Ill. (Divides time with KUSD) (250 watts at night)	500	336.9	890	Cent.	WJBU	—Lewisburg, Pa. — Bucknell Univ. Engrg. Bldg. (Divides time with WBAX)	100	247.8	1210	East.	
WHPP	—New York, N. Y. (Trans. in Englewood Cliffs, N. J.) — Bronx Brdcast. Co. (Divides time with WLBH-WMRJ)	10	211.1	1420	East.	WINR	—Bay Shore, N. Y. — Radiotel Mfg. Co., Carleton Hall (Divides time with WJBI-WGGB-WCOH)	100	247.8	1210	East.	WJBW	—New Orleans, La. — C. Carlson, Jr., 2743 Dumaine St. (Divides time with WABZ)	30	249.9	1200	Cent.	
WHT	—Chicago, Ill. (Trans. in Deerfield) — Radiophone Broadcasting Corp., 410 N. Mich. Blvd. (Divides time with WJAZ - WORD - WIBO)	5000	202.6	1480	Cent.	WIOD	—Miami Beach, Fla. — Isle of Dreams Brdcast. Co. (Divides time with WQAM)	1000	241.8	1240	East.	WJBY	—Gadsden, Ala. — Elec. Const. Co., 517 Broad St.	50	247.8	1210	Cent.	
WIAD	—Philadelphia, Pa. — Hotel Vendig (Divides time with WEAM)	100	218.8	1370	East.	WIP	—Philadelphia, Pa. — Gimbel Bros., Market St. Bldg. (Divides time with WFAN)	500	491.5	610	East.	WJJD	—Mooseheart, Ill. — Supreme Lodge, Loyal Order of Moose (Limited)	20000	254.1	1180	Cent.	
WIAS	—Ottumwa, Iowa — Poling Elec. Co., 107 E. 2nd St. (Divides time with KICK)	100	211.1	1420	Cent.	WISN	—Milwaukee, Wis. — Wisconsin News 115 Michigan St. (Divides time with WHAD)	250	267.7	1120	Cent.	WJKS	—Gary, Ind. — Johnson Kennedy Radio Corp., 540 Lake St. (Divides time with WGES)	500	220.4	1360	Cent.	
WIBA	—Madison, Wis. — Capital Times Studio & Strand Theatre Corp., 14 E. Mifflin St.	100	247.8	1210	Cent.	WJAD	—Waco, Tex. — Frank P. Jackson, 801 Austin Ave. (Divides time with KFQB)	1000	241.8	1240	Cent.	WJR	—Detroit, Mich. (Trans. in Pontiac) — Good Will Sta. WJR, Inc. & Detroit Free Press, Genl. Motors Bldg. & Book Cadillac Hotel	5000	399.8	750	East.	
WIBG	—Elkins Park, Pa. — St. Paul's P. E. Ch. (Daytime)	50	322.4	930	East.	WJAG	—Norfolk, Nebr. — Norfolk Daily News, Hotel Norfolk (Limited)	500	282.8	1060	Cent.	WJSV	—Mt. Vernon Hills, Va. — Independent Pub. Co., 339 Pennsylvania Ave., N. W., Wash., D. C.	10000	205.4	1460	East.	
WIBM	—Jackson, Mich. — C. L. Carrell (Divides time with WJBK)	100	218.8	1370	Cent.	WJAK	—Kokomo, Ind. — J. A. Kautz, Y.M.C.A. Bldg. (Divides time with WLBC)	50	228.9	1310	Cent.	WJZ	—New York, N. Y. (Trans. in Bound Brook, N. J.) — Natl. Brdcast. Co., 711 Fifth Ave.	30000	394.5	760	East.	
WIBO	—Chicago, Ill. (Trans. in Desplaines) — Nelson Bros., Bond & Mtg. Co. (Divides half time with WNAX - WHA-WPCC)	5000	526	570	Cent.	WJAR	—Providence, R. I. — The Outlet Co.	250	336.9	890	East.	WKAR	—East Lansing, Mich. — Michigan State College (Daytime only)	500	288.3	1040	Cent.	
WIBR	—Steubenville, Ohio — Thurman A. Owings (Divides time with WQBZ)	50	211.1	1420	East.	WJAS	—Pittsburgh, Pa. — M. H. Pickering Furn. Co.	1000	232.4	1290	East.	WKAV	—Laconia, N. H. — Laconia Radio Club, Auditorium, Pub. Serv. Co. of N. H.	50	228.9	1310	East.	
WIBS	—Elizabeth, N. J. — New Jersey Brdcast. Corp., 80 Broad St. (Divides time with WBMS-WNJ-WKBO)	250	206.8	1450	East.	WJAX	—Jacksonville, Fla. — City of Jacksonville, Waterworks Park, 1st and Main Sts.	1000	238	1260	East.	WKBB	—Joliet, Ill. — Sanders Bros., 607 Jefferson St. (Divides time with WCLS - WEHS - WKBI-WHFC)	100	228.9	1310	Cent.	
WIBU	—Poynette, Wis. — Wisconsin State Jour.	100	228.9	1310	Cent.	WJAY	—Cleveland, Ohio Cleveland Radio Brdcast. Corp., Hotel Hollenden (Divides time with WFJC)	500	206.8	1450	East.	WKBC	—Birmingham, Ala. — H. L. Ansley, 1428 N. Twelfth Ave.	10	228.9	1310	Cent.	
						WJAZ	—Chicago, Ill. (Trans. in Mt. Prospect) — Zenith Radio Corp., 3620 Iron St. (Divides time with WORD - WIBO-WHT)	5000	202.6	1480	Cent.	WKBE	—Webster, Mass. — K. & B. Elec. Co., 59 Emerald Ave. (Divides time with WEPS)	100	249.9	1200	East.	
						WJBB	—St. Petersburg, Fla. (Trans. in Sarasota) — Financial Jour., 126-13th St., N.	250	296.9	1010	East.	WKBF	—Indianapolis, Ind. — Noble B. Watson, Hoosier Ath. Club. (Divides time with WBAA-WCMA)	500	214.2	1400	Cent.	
						WJBC	—LaSalle, Ill. — Hummer Furn. Co., 2nd & Joliet Sts. (Divides time with WJBL)	100	249.9	1200	Cent.							

Radio Call Stations	Broadcast Stations, Location and Owner	Power	Wave length	Kilocycles	Time at Station	Radio Call Stations	Broadcast Stations, Location and Owner	Power	Wave length	Kilocycles	Time at Station	Radio Call Stations	Broadcast Stations, Location and Owner	Power	Wave length	Kilocycles	Time at Station
<b>WKBH</b>	—La Crosse, Wis.—Callaway Music Co., 221 Main St. (Divides time with KSO)	1000	217.3	1380	Cent.	<b>WLBF</b>	—Kansas City, Mo.—Everett L. Dillard, 32nd & Main Sts.	100	211.1	1420	Cent.	<b>WMAF</b>	—South Dartmouth, Mass.—Round Hills Radio Corp. (Divides time with WBET)	500	220.4	1360	East.
<b>WKBI</b>	—Chicago, Ill.—Fred L. Schoenwolf, Lincoln Tr. & Sav. Bank Bldg. (Divides time with WHFC - WKBB - WCLS-WEHS)	50	228.9	1310	Cent.	<b>WLBG</b>	—Petersburg, Va.—R. A. Gamble	100	249.9	1200	East.	<b>WMAK</b>	—Buffalo, N. Y. (Trans. in Martinsville)—WMAK Brdcast. Sta. (Divides time with WFBL)	750	333.1	900	East.
<b>WKBN</b>	—Youngstown, Ohio—Radio Elec. Serv. Y. M. C. A. (Divides time with WSMK)	500	526	570	East.	<b>WLBH</b>	—Farmingdale, N. Y.—Joseph J. Lombardi (Divides time with WHPP-WMRJ)	30	211.1	1420	East.	<b>WMAL</b>	—Washington, D. C.—M. A. Leese Radio Co., 720 Eleventh St. N. W.	250	475.9	630	East.
<b>WKBO</b>	—Jersey City, N. J.—Camith Corp., 2866 Blvd. (Divides time with WBMS-WNJ-WIBS)	250	206.8	1450	East.	<b>WLBL</b>	—Stevens Point, Wis.—Wis. Dept. of Markets (Daytime only)	5000	333.1	900	Cent.	<b>WMAN</b>	—Columbus, Ohio—W. E. Heskett Radio Station, 507 N. High St.	50	247.8	1210	East.
<b>WKBP</b>	—Battle Creek, Mich.—Battle Creek Enquirer & News	50	211.1	1420	East.	<b>WLBO</b>	—Galesburg, Ill.—Frederick Trebbe, Jr. (Divides time with WKBS)	100	228.9	1310	Cent.	<b>WMAQ</b>	—Chicago, Ill.—Chicago Daily News, 15 North Wells St.	5000	447.5	670	Cent.
<b>WKBQ</b>	—New York, N. Y.—Standard Cahill Co., Inc., 1100 E. 177th St. (Divides time with WBNY-WMSG-WCDA)	250	222.1	1350	East.	<b>WLBV</b>	—Mansfield, Ohio—Mansfield Brdcast. Assn., Cham. of Comm. Bldg.	100	247.8	1210	East.	<b>WMAY</b>	—St. Louis, Mo.—Kings Highway Presbyterian Church (Divides time with KFWF)	100	249.9	1200	Cent.
<b>WKBS</b>	—Galesburg, Ill.—P. N. Nelson, 227 Duffield Ave. (Divides time with WLBO)	100	228.9	1310	Cent.	<b>WLBW</b>	—Oil City, Pa.—Petroleum Telephone Co.	500	238	1260	East.	<b>WMAZ</b>	—Macon, Ga.—Mercer Univ. (Divides time with WGST) (Uses 250 Watts at Night)	500	336.9	890	East.
<b>WKBT</b>	—New Orleans, La.—First Bapt. Ch.	50	211.1	1420	Cent.	<b>WLBX</b>	—Long Island City, N. Y.—John N. Brahy, 283 Crescent St. (Divides time with WCLB-WWRL-WMBQ)	100	199.9	1500	East.	<b>WMBA</b>	—Newport, R. I.—LeRoy Joseph Beebe, 19 Broadway	100	199.9	1500	East.
<b>WKBV</b>	—Brookville, Ind.—Knox Battery & Elec. Co., 1058 Main St.	100	199.9	1500	Cent.	<b>WLBZ</b>	—Dover-Foxcroft, Me.—Thompson L. Guernsey	500	483.6	620	East.	<b>WMBC</b>	—Detroit, Mich.—Mich. Brdcast. Co., Savoy Hotel	100	211.1	1420	East.
<b>WKBW</b>	—Buffalo, N. Y. (Trans. in Amherst)—Churchill Evan. Assn., 1420-1428 Main St.	5000	204	1470	East.	<b>WLBI</b>	—Ithaca, N. Y.—Lutheran Assn. of Ithaca	50	247.8	1210	East.	<b>WMBD</b>	—Peoria Heights, Ill.—Peoria H's. Radio Lab., 107 E. Glen Ave. (Divides time with WTAD)	500	208.2	1440	Cent.
<b>WKBZ</b>	—Ludington, Mich.—Karl L. Ashbacher, First Natl. Bank Bldg.	50	199.9	1500	East.	<b>WLBJ</b>	—Lexington, Mass.—The Lexington Air Sta., 131 Willow Ave. (Divides time with WSSH) (250 Watts Daytime)	100	211.1	1420	East.	<b>WMBF</b>	—Miami Beach, Fla.—Fleetwood Hotel Corp.	500	535.4	560	East.
<b>WKEN</b>	—Buffalo, N. Y. (Trans. in Grand Island)—WKEN, Inc., 2 E. Hazeltine Ave. (Limited)	1000	288.3	1040	East.	<b>WLBT</b>	—Chicago, Ill. (Trans. in Elgin)—Liberty Weekly	25000	416.4	720	Cent.	<b>WMBG</b>	—Richmond, Va.—Havens & Martin, 914 W. Broad St. (Divides time with WTAZ)	100	247.8	1210	East.
<b>WKJC</b>	—Lancaster, Pa.—Kirk Johnson & Co., 16 W. King St. (Divides time with WPRC)	100	249.9	1200	East.	<b>WLIT</b>	—Philadelphia, Pa.—Lit Bros., 8th & Market Sts. (Divides time with WFI)	500	535.4	560	East.	<b>WMBH</b>	—Joplin, Mo.—Edwin Dudley Aber, 1526 E. Fifty-third St.	100	211.1	1420	Cent.
<b>WKRC</b>	—Cincinnati, Ohio—Kodel Radio Corp., 507 E. Pearl St. (Divides time with WEAO)	500	545.1	550	Cent.	<b>WLOE</b>	—Chelsea, Mass.—N. E. Brdcast. Co., 56 Wash. Ave. (Divides time with WMES)	100	199.9	1500	East.	<b>WMBI</b>	—Chicago, Ill. (Trans. in Addison)—Moody Bible Inst. of Chicago, 153 Institute Pl. (Divides time with WCBBD) (Limited)	5000	277.6	1080	Cent.
<b>WKY</b>	—Oklahoma City, Okla.—WKY Radiophone Co., Huckins Hotel	1000	333.1	900	Cent.	<b>WLS</b>	—Chicago, Ill. (Trans. in Crete)—Prairie Farmer (Divides time with WENR-WBCN)	5000	344.6	870	Cent.	<b>WMBL</b>	—Lakeland, Fla.—Benford Radio Studios, 121 N. Kentucky Ave.	100	228.9	1310	East.
<b>WLAC</b>	—Nashville, Tenn.—Dad's Auto Acces. & Radio Store & The Life & Cas. Ins. Co. (Divides time with WBAW)	5000	201.2	1490	Cent.	<b>WLSI</b>	—Cranston, R. I.—Dutee W. Flint and Lincoln Studios, Inc., 335 Westminster St., Providence (Divides time with WFCI)	100	247.8	1210	East.	<b>WMBM</b>	—Memphis, Tenn.—Seventh Day Adventist Church	10	199.9	1500	Cent.
<b>WLAP</b>	—Louisville, Ky.—Virginia Ave. Baptist Church, 2600 Virginia Ave.	30	249.9	1200	Cent.	<b>WLTH</b>	—Brooklyn, N. Y.—Flatbush Radio Labs., 1421 E. 10th St. (Divides time with WCGU-WBBC-WSGH-WSDA)	500	214.2	1400	East.	<b>WMBO</b>	—Auburn, N. Y.—Radio Serv. Lab., 17 South St.	100	218.8	1370	East.
<b>WLB</b>	—Minneapolis, Minn.—Univ. of Minn. (Divides time with W C A L - K F M X - WRHM)	1000	239.9	1250	Cent.	<b>WLW</b>	—Cincinnati, Ohio (Trans. in Harrison)—Crosley Radio Corp.	5000	428.3	700	Cent.	<b>WMBQ</b>	—Brooklyn, N. Y.—Paul J. Gollhofer, 95 Leonard St. (Divides time with WCLB-WLBX-WWRL)	100	199.9	1500	East.
<b>WLBC</b>	—Muncie, Ind.—D. A. Burton, 2224 So. Jefferson St. (Divides time with WJAK)	50	228.9	1310	Cent.	<b>WLWL</b>	—New York, N. Y. (Trans. in Kearney, N. J.)—Paulist Fathers, 415 W. 59th St. (Divides time with WPG)	5000	272.6	1100	East.	<b>WMBR</b>	—Tampa, Fla.—F. J. Reynolds	100	247.8	1210	East.
						<b>WMAC</b>	—Cazenovia, N. Y.—Clive B. Meredith (Divides time with WSYR)	500	526	570	East.	<b>WMBS</b>	—Harrisburg, Pa. (Trans. in Lemoyne)—Mack's Battery Co. (Divides time with WCAH)	500	209.7	1430	East.

Radio Call Stations	Broadcast Stations, Location and Owner	Power	Wave length	Kilocycles	Time at Station	Radio Call Stations	Broadcast Stations, Location and Owner	Power	Wave length	Kilocycles	Time at Station	Radio Call Stations	Broadcast Stations, Location and Owner	Power	Wave length	Kilocycles	Time at Station	
<b>WMC</b> —Memphis, Tenn.	—Memphis Coml. Appeal, Inc., Coml. Appeal Bldg.	500	384.4	780	Cent.	<b>WNBW</b> —Carbondale, Pa.	—Home Cut Glass & China Co., 21 Salem Ave.	5	249.9	1200	East.	<b>WOO</b> —Philadelphia, Pa.	—John Wanamaker (Divides time with WHBW-WALK-WPSW)	100	199.9	1500	East.	
<b>WMCA</b> —New York, N. Y.	(Trans. in Hoboken, N. J.)—Asso. Broadcasters, Inc., Hotel McAlpin. (Divides time with WNYC)	500	526	570	East.	<b>WNBX</b> —Springfield, Vt.	—First Cong. Church (Divides time with WCAX)	10	249.9	1200	East.	<b>WOOD</b> —Grand Rapids, Mich.	(Trans. in Farnwood, Walter B. Stiles, Inc., Hotel Rowe (Divides time with WASH))	500	236.1	1270	Cent.	
<b>WMES</b> —Boston, Mass.	—Educational Society, Barristers Hall (Divides time with WLOE)	50	199.9	1500	East.	<b>WNBZ</b> —Saranac Lake, N. Y.	—Smith & Mace (Daytime only)	10	232.4	1290	East.	<b>WOQ</b> —Kansas City, Mo.	—Unity School of Christianity (Divides time with WDAF)	1000	491.5	610	Cent.	
<b>WMMN</b> —Fairmont, W. Va.	—Holt-Howe Nov. Co., Hotel Fairmont (Uses 500 Watts at Night)	250	336.9	890	East.	<b>WNEW</b> —Norfolk, Va.	—Radio Corp. of Va.	100	228.9	1310	East.	<b>WOR</b> —Newark, N. J.	(Trans. in Kearney)—L. Bamberger & Co.	5000	422.3	710	East	
<b>WMPC</b> —Lapeer, Mich.	—First Meth. Protestant Church	30	199.9	1500	East.	<b>WNJ</b> —Newark, N. J.	—Radio Inv. Co., 89 Lehigh Ave. (Divides time with WBMS-WKBO-WIBS)	250	206.8	1450	East.	<b>WORD</b> —Chicago, Ill.	(Trans. in Batavia)—People's Pulpit Assn., 124 Columbia Heights, Bklyn., N. Y. (Divides quarter time with WHT-WIBO-WJAZ)	5000	202.6	1480	Cent.	
<b>WMRJ</b> —Jamaica, N. Y.	—Peter J. Prinz, 10 New York Blvd. (Divides time with WLBH-WHPP)	10	211.1	1420	East.	<b>WNOX</b> —Knoxville, Tenn.	—People's Tel. & Tel. Co., 313 Commerce Ave.	1000	535.4	560	Cent.	<b>WOS</b> —Jefferson City, Mo.	—Missouri State Marketing Bureau (Divides time with KFRU-WGBF)	500	475.9	630	Cent	
<b>WMSG</b> —New York, N. Y.	—Mad. Sq. Garden Brdcast. Corp., 319 W. 49th St. (Divides time with WBNY-WCDA-WKBQ)	250	222.1	1350	East.	<b>WNRC</b> —Greensboro, N. C.	—Wayne M. Nelson	500	208.2	1440	East.	<b>WOV</b> —New York, N. Y.	(Trans. in Secaucus, N. J.)—Interl. Brdcast. Corp., 485 Fifth Ave. (Daytime)	1000	265.3	1130	East	
<b>WMT</b> —Cedar Rapids, Iowa	(Trans. in Waterloo)—Waterloo Brdcast. Co., 322 Third Ave. W. (Divides time with KFJB)	100	249.9	1200	Cent.	<b>WNYC</b> —New York, N. Y.	—Dept. of Plant & Structures, Municipal Bldg. (Divides time with WMCA)	500	526	570	East.	<b>WOW</b> —Omaha, Nebr.	—Woodmen of the World Life Ins. Assn. (Divides time with WCAJ)	1000	508.2	590	Cent	
<b>WNAC</b> —Boston, Mass.	—The Shepard Stores (New transmitter under const.)	500	243.8	1230	East.	<b>WOAI</b> —San Antonio, Tex.	—So. Equip. Co., 1031 Navarro St. (Divides time with WRR)	5000	252	1190	Cent.	<b>WOWO</b> —Fort Wayne, Ind.	—The Main Auto Supply Co., 213 W. Main St. (Divides time with WWVA)	5000	258.5	1160	Cent.	
<b>WNAD</b> —Norman, Okla.	—Univ. of Okla. (Divides time with KGGF)	500	296.9	1010	Cent.	<b>WOAN</b> —Lawrenceburg, Tenn.	—Church of the Nazarene & Vaughan School of Music (Divides time with WREC)	500	499.7	600	Cent.	<b>WPAP</b> —New York, N. Y.	(Trans. in Cliffside, N. J.)—Palisades Amusement Park, 1540 Bway. (Divides time with WHN-WRNY)	250	296.9	1010	East.	
<b>WNAT</b> —Philadelphia, Pa.	—Lennig Bros. Co., Spring Garden & 9th Sts. (Divides time with WFKD-WABY)	100	228.9	1310	East.	<b>WOAX</b> —Trenton, N. J.	—Franklyn J. Wolff, The Monument Pottery Co. (Divides time with WCAM-WCAP)	500	234.2	1280	East.	<b>WPCC</b> —Chicago, Ill.	—North Shore Congregational Church (Divides time with WRM-WHA)	500	526	570	Cent.	
<b>WNAX</b> —Yankton, S. Dak.	—Gurney Seed and Nursery Co. (Divides half time with WIBO-WHA-WPCC)	500	526	570	Cent.	<b>WOBT</b> —Union City, Tenn.	—Tittsworth's Radio & Music Shop, 114 South First St.	15	228.9	1310	Cent.	<b>WPCH</b> —New York, N. Y.	(Trans. in Hoboken, N. J.)—Concourse Radio Corp., Hotel McAlpin, Bway. & 34th St. (Daytime only)	500	370.2	810	East.	
<b>WNBF</b> —Endicott, N. Y.	—Howitt-Wood Radio Co., Inc., 117 W. Main St., Hotel Frederick	50	199.9	1500	East.	<b>WOBU</b> —Charleston, W. Va.	—Charleston Radio Brdcast. Co., 1026 Quarrier St. (Divides time with WSAZ)	250	516.9	580	East.	<b>WPG</b> —Atlantic City, N. J.	—Municipality of Atlantic City (Divides time with WLWL)	5000	272.6	1100	East.	
<b>WNBH</b> —New Bedford, Mass.	—New Bedford Brdcast. Co., New Bedford Hotel	100	228.9	1310	East.	<b>WOC</b> —Davenport, Iowa	—The Palmer School of Chiropractic, 1002 Brady St. (Divides time with WHO)	5000	299.8	1000	Cent.	<b>WPOR</b> —Norfolk, Va.	—Reliance Elec. Co., 519 W. 21st St. (Divides time with WSEA)	500	384.4	780	East.	
<b>WNBK</b> —Knoxville, Tenn.	—Lonsdale Bapt. Church, 122 W. Conn. Ave.	50	228.9	1310	Cent.	<b>WOCL</b> —Jamestown, N. Y.	—A. E. Newton	25	247.8	1210	East.	<b>WPRC</b> —Harrisburg, Pa.	—Wilson Printing & Radio Co., Fifth & Kelder Sts. (Divides time with WKJC)	100	249.9	1200	East.	
<b>WNBO</b> —Washington, Pa.	—John B. Spriggs, So. Main St.	15	249.9	1200	East.	<b>WODA</b> —Paterson, N. J.	—James K. O'Dea, Inc., 115 Ellison St. (Divides time with WAAM-WGCP)	1000	239.9	1250	East.	<b>WPSC</b> —State College, Pa.	—Penna. State Coll. (Daytime only)	500	243.8	1230	East.	
<b>WNBQ</b> —Rochester, N. Y.	—Gordon P. Brown, 192 S. Goodman St.	15	199.9	1500	East.	<b>WOI</b> —Ames, Iowa	—Iowa State Coll. (Divides time with KFEQ) (Daytime)	3500	535.4	560	Cent.	<b>WPSW</b> —Philadelphia, Pa.	—Phila. School of Wireless Tel., 1533 Pine St. (Divides time with WALK-WOO-WPSW)	50	199.9	1500	East.	
<b>WNBR</b> —Memphis, Tenn.	—Popular Radio Shop, 883 Poplar Ave. (Divides time with WGBC)	500	209.7	1430	Cent.	<b>WOKO</b> —Poughkeepsie, N. Y.	(Trans. at Mt. Beacon Summit)—Harold E. Smith, Hotel Windsor (Divides time with WHEC-WABO-WMAC)	500	208.2	1440	East.	<b>WPTF</b> —Raleigh, N. C.	—Durham Life Ins. Co., 226½ Fayetteville St.	5000	440.9	680	East.	
						<b>WOL</b> —Washington, D. C.	—Amer. Brdcast. Co., Hotel Annapolis (Daytime only)	150	236.1	1270	East.							
						<b>WOMT</b> —Manitowoc, Wis.	—Mikadow Thea.	100	247.8	1210	Cent.							

Radio Call Stations	Broadcast Stations, Location and Owner	Power	Wave length	Kilocycles	Time at Station	Radio Call Stations	Broadcast Stations, Location and Owner	Power	Wave length	Kilocycles	Time at Station	Radio Call Stations	Broadcast Stations, Location and Owner	Power	Wave length	Kilocycles	Time at Station
<b>WQAM</b>	—Miami, Fla. Elec. Equip. Co., 42 Northwest Fourth St. (Divides time with WIOD)	1000	241.8	1240	East	<b>WRC</b>	—Washington, D. C.—Radio Corp. of America.	500	315.6	950	East	<b>WSDA</b>	—Brooklyn, N. Y.—Amateur Radio Spec. Co., 77 Cortlandt St., N. Y. (Divides time with WBBC-WCGU-WLTH)	500	214.2	1400	East
<b>WQAN</b>	—Scranton, Pa.—Scranton Times, Penn Ave. & Spruce St. (Divides time with WGBI)	250	340.7	880	East	<b>WREC</b>	—Memphis, Tenn.—WREC, Inc. (Divides time with WOAN)	500	499.7	600	Cent	<b>WSEA</b>	—Virginia Beach, Va. (Trans. at Portsmouth) — Va. Beach Brdcast. Co., Cavalier Hotel, Main Studio at Norfolk (Divides time with WTAR-WPOR)	500	384.4	780	East
<b>WQAO</b>	—Cliffside, N. J.—Calvary Bapt. Ch., 123 W. 57th St., New York City (Divides time with WHN - WRNY)	250	296.9	1010	East	<b>WREN</b>	—Lawrence, Kan.—Jenny Wren, Inc. (Divides time with KFKU)	1000	245.8	1220	Cent	<b>WSGH</b>	—Brooklyn, N. Y.—Amateur Radio Spec. Co., 77 Cortlandt St., N. Y. (Divides time with WBBC-WCGU-WLTH)	500	214.2	1400	East
<b>WQBC</b>	—Utica, Miss.—Utica Chamber of Com.	300	220.4	1360	Cent	<b>WRHM</b>	—Minneapolis, Minn.—Rosedale Hospital Co., Inc., Andrews Hotel (Divides time with WCAL-KFMX-WLB)	1000	239.9	1250	Cent	<b>WSIX</b>	—Springfield, Tenn.—Six Thirty Eight Tire & Vulc. Co.	100	247.8	1210	Cent
<b>WQBJ</b>	—Clarksburg, W. Va.—John Raikes Willow Beach Club	65	249.9	1200	East	<b>WRJN</b>	—Racine, Wis.—Racine Brdcast. Corp., Hotel Racine (Divides time with WCLO)	100	249.9	1200	Cent	<b>WSKC</b>	—Bay City, Mich.—World's Star Knitting Co.	500	212.6	1410	East
<b>WQBZ</b>	—Weirton, W. Va.—J. H. Thompson, 3337 Elm St. (Divides time with WIBR)	60	211.1	1420	East	<b>WRK</b>	—Hamilton, Ohio—Doron Bros., Elec. Co., 325-329 North "B"	100	228.9	1310	East	<b>WSM</b>	—Nashville, Tenn.—The Natl. Life & Acc. Ins. Co., National Bldg.	5000	461.3	650	Cent
<b>WRAF</b>	—Laport, Ind.—The Radio Club, Inc., 719 Michigan Ave. (Divides time with WWAE)	100	249.9	1200	Cent	<b>WRNY</b>	—New York, N. Y. (Trans. in Coytesville, N. J.)—Experimenter Pub. Co., 230 Fifth Ave. (Divides time with WQAO-WPAP-WHN)	250	296.9	1010	East	<b>WSMB</b>	—New Orleans, La.—Saenger Amusement Co. and Maison Blanche Co.	750	227.1	1320	Cent
<b>WRAK</b>	—Erie, Pa.—C. R. Cummins, 1931 State St.	50	218.8	1370	East	<b>WRR</b>	—Dallas, Tex.—City of Dallas, Police and Fire Signal Dept. (Divides time with WOAI)	5000	252	1190	Cent	<b>WSMD</b>	—Takoma Park, Md. (Trans. in Salisbury)—Tom F. Little	100	228.9	1310	East
<b>WRAW</b>	—Reading, Pa.—Avenue Radio & Elec. Shop, 460 Schuylkill Ave. (Divides time with WGAL)	100	228.9	1310	East	<b>WRUF</b>	—St. Petersburg, Fla. (Trans. in Gainesville)—Univ. of Florida	5000	204	1470	East	<b>WSMK</b>	—Dayton, Ohio—S. M. K. Radio Corp., 39 E. Third St. (Divides time with WKBN)	200	526	570	East
<b>WRAX</b>	—Philadelphia, Pa.—Berachah Church, Inc., 1608 Allegheny Ave. (Divides time with WABF)	250	208.2	1440	East	<b>WRVA</b>	—Richmond, Va.—Larus & Bro. Co., Inc. 22nd & Cary Sts.	5000	270.1	1110	East	<b>WSPD</b>	—Toledo, Ohio—Toledo Brdcast. Co.	500	223.7	1340	East
<b>WRBC</b>	—Valparaiso, Ind.—Immanuel Luth. Church (Daytime)	500	241.8	1240	Cent	<b>WSAI</b>	—Cincinnati, Ohio (Trans. in Mason)—U. S. Playing Card Co., Crosley R. Corp., Lessee (Limited time)	5000	374.8	800	Cent	<b>WSRO</b>	—Middletown, Ohio—Middletown Brdcast. Co., Central & Canal Sts. (Divides time with WAAD)	100	211.1	1420	Cent
<b>WRBH</b>	—Manchester, N. H.—New Hampshire Brdcast. Co., 33 Kimball St.	500			East	<b>WSAJ</b>	—Grove City, Pa.—Grove City College	100	228.9	1310	East	<b>WSSH</b>	—Boston, Mass.—Tremont Temple Baptist Church (Divides time with WLEX)	100	211.1	1420	East
<b>WRBI</b>	—Tifton, Ga.—Kent's Furn. & Music Store (Divides time with WTHS)	20	228.9	1310	Cent	<b>WSAN</b>	—Allentown, Pa.—Allentown Call Pub. Co. (Divides time with WCBA)	100	199.9	1500	East	<b>WSUI</b>	—Iowa City, Iowa—State Univ. of Iowa (Divides time with KSAC)	500	516.9	580	Cent
<b>WRBJ</b>	—Hattiesburg, Miss.—Woodruff Furn. Co., 119 W. Pine St.	10	199.9	1500	Cent	<b>WSAR</b>	—Portsmouth, R. I. (Trans. in Fall River, Mass.)—Doughty & Welch Elec. Co., 46 N. Main St.	250	206.8	1450	East	<b>WSUN</b>	—St. Petersburg, Fla. (Trans. in City Hall Park at Causeway)—Cham. of Com.	1000	333.1	900	East
<b>WRBL</b>	—Columbus, Ga.—R. E. Martin	50	249.9	1200	Cent	<b>WSAZ</b>	—Huntington, W. Va.—McKellar Elec. Co., 1143 Fourth Ave. (Divides time with WOBV)	250	516.9	580	East	<b>WSVS</b>	—Buffalo, N. Y.—Seneca Voc. School, 666 E. Delavan Ave.	50	218.8	1370	East
<b>WRBQ</b>	—Greenville, Miss.—J. Pat Scully	100	247.8	1210	Cent	<b>WSB</b>	—Atlanta, Ga.—The Atlanta Journal	10000	405.2	740	Cent	<b>WSYR</b>	—Syracuse, N. Y.—Clive B. Meredith, Hotel Syracuse	250	526	570	East
<b>WRBT</b>	—Wilmington, N. C.—Wilmington Radio Assn., 720 North Fourth St.	50	218.8	1370	East	<b>WSBC</b>	—Chicago, Ill.—World Battery Co., 1219 S. Wabash Ave. (Divides time with WEDC-WCRW)	100	247.8	1210	Cent	<b>WTAD</b>	—Quincy, Ill.—Illinois Stock Medicine Brdcast. Corp. (Divides time with WMBD)	500	208.2	1440	Cent
<b>WRBU</b>	—Gastonia, N. C.—A. J. Kirby Music Co., 221 E. Main St.	100	247.8	1210	East	<b>WSBT</b>	—South Bend, Ind.—South Bend Tribune, 225 W. Colfax St. (Divides time with WFBM-WCWK)	500	243.8	1230	Cent	<b>WTAG</b>	—Worcester, Mass.—Worcester Telegram Pub. Co., 18 Franklin St.	250	516.9	580	East
<b>WRBW</b>	—Columbia, S. C.—Paul S. Pearce, 2011 Green St.	100	228.9	1310	East												

Radio Call Stations	Broadcast Stations, Location and Owner	Power	Wave length	Kilocycles	Time at Station	Radio Call Stations	Broadcast Stations, Location and Owner	Power	Wave length	Kilocycles	Time at Station	Radio Call Stations	Broadcast Stations, Location and Owner	Power	Wave length	Kilocycles	Time at Station	
WTAM	Cleveland Ohio—Willard Storage Batt. Co., 1100 Chester Ave. (Divides time with WEAR)	3500	280/2	1070	East.	WTAZ	Richmond, Va.—Thos. J. McGuire (Divides time with WMBG)	150	247.8	1210	East.	WWAE	Chicago, Ill. (Trans. in Hammond)—Dr. Geo. F. Courier, 2024 So. Wabash Ave. (Divides time with WRAF)	100	249.9	1200	Cent.	
WTAQ	Eau Claire, Wis.—Gillette Rubber Co. (Divides time with KSCJ)	1000	225.4	1330	Cent.	WTBO	Cumberland, Md.—Cumberland Elec. Co., 138 Va. Ave.	50	211.1	1420	East.	WWJ	Detroit, Mich.—Evening News Assoc.	1000	325.9	920	East.	
WTAR	Norfolk, Va.—Reliance Elec. Co., 519 W. 21st St. (Divides time with WSEA)	500	384.4	780	East.	WTBQ	Wilmington, Del.—E. Brandt Boylan, 2303 Franklin St.	100	199.9	1500	East.	WWL	New Orleans, La.—Loyola Univ. (Divides time with KWKH)	5000	352.7	850	Cent.	
WTAS	Batavia, Ill.—Illinois Brdcast. Co.	15000	461.4	720	Cent.	WTFI	Toccoa Falls, Ga.—Toccoa Falls Inst.	500	206.8	1450	East.	WWNC	Asheville, N. C.—Asheville Cham. of Com., 101 Patton Ave.	1000	526	570	Cent.	
WTAW	College Station, Tex.—Agricul. & Mech. Coll. of Texas (Divides time with KUT)	500	267.7	1120	Cent.	WTHS	Atlanta, Ga.—Atlanta Technological High School. (Divides time with WRBI)	100	228.9	1310	Cent.	WWRL	Woodside, N. Y.—W. H. Rauman (Divides time with WMBQ-WLBX-WCLB)	100	199.9	1500	East.	
WTAX	Streator, Ill.—Williams Hdwe. Co., 115 So. Vermillion St. (Divides time with WCBS)	50	247.8	1210	Cent.	WTIC	Hartford, Conn.—Travelers Ins. Co. (Temp. assigned to 600 Kc., 250 Watts, pending completion of trans.)	50000	282.2	1060	East.	WWVA	Wheeling, W. Va.—W. Va. Brdcast. Corp., 1229 Main St. (Divides time with WOWO)	5000	258.5	1160	East.	
						WTMJ	Milwaukee, Wis. (Trans. in Brookfield)—Milwaukee Jrnl. (Divides time with WHA)	1000	483.6	620	Cent.							

**This list has been corrected up to and including Dec. 10th, 1928**

The following changes have been made by the commission after these lists had been composed.

WNEW	Newport News, Va.	Call letters changed to WGH	KWK	St. Louis, Mo.	Changed to 1350 kilocycles; 1000 watts
KFOA	Seattle, Wash.	Call letters changed to KOL	WBAK	Harrisburg, Pa.	Changed to 1430 kilocycles
KFWO	Avalon, Cal.	Deleted—Effective January 1st.	WDGY	Minneapolis, Minn.	Changed to 1390 kilocycles
KGIW	Trinidad, Colo.	Granted construction permit for 100 watts, 1420 kilocycles	WEBR	Baltimore, Md.	Changed to 1270 kilocycles
KQKX	Sand Point, Idaho	Licensed to construct a 15-watt station on 1420 kilocycles	WFCI	Pawtucket, R. I.	Call letters changed to WPAW
KOOS	Marshfield, Ore.	Licensed to construct a 50-watt station on 1370 kilocycles	WHDF	Calumet, Mich.	Granted construction permit for 100 watts on 1370 kilocycles
KTAB	Oakland, Cal.	Changed to 550 kilocycles	WHOH	Gloucester, Mass.	Granted construction permit 1000 watts day-time on 830 kilocycles
			WHDI	Minneapolis, Minn.	Changed to 1390 kilocycles, shares time with WGDY temporarily



VOL. NO. 5

**RADIO NEWS**

1929

**AMATEURS' HANDIBOOK**

**Complete Diagrams and Construction Data on the Latest Radio and Television Circuits**

Every "fan" should own a copy of the new 1929 edition of RADIO NEWS AMATEURS' HANDIBOOK. The latest and

most complete guide to "what's new in radio and television" that money can buy. Every year as a new revised edition of this valuable book is published over fifty thousand radio fans avidly snatch their copy and place it with its predecessors in their library for continual reference. In fact these books have been truly said to chronicle the entire growth of the radio industry.

The big new 1929 issue is of particular interest. There are over twenty-five complete construction articles, fully illustrated with appropriate

**Experimenter Publishing Co.**  
230 Fifth Avenue New York

diagrams and covering every conceivable angle of radio assembly work. There are several articles dealing with the construction of Television circuits, Short Wave sets, Amplifiers, Electric sets and so forth. Further, there are many pages of helpful hints to the experimenting "fan."

Over 112 pages—Large magazine size (9"x 12")—Complete with circuits and illustrations—Beautiful colored cover.

**50c the copy**

At All Newsstands or Write Direct.

**Mail this coupon Now**

EXPERIMENTER PUBLISHING CO.,  
230 Fifth Avenue, New York.

Gentlemen:  
Enclosed find 50c. Kindly send me a copy of the NEW 1929 ISSUE OF RADIO NEWS AMATEURS' HANDIBOOK.

NAME .....

ADDRESS .....

CITY ..... STATE .....

# RADIO BROADCAST STATIONS OF THE UNITED STATES

## By Wavelengths and Frequencies

Figures in brackets ( ) stand for power of Stations in Watts

**199.9 Meters. 1500 Kilocycles**  
KFCR Santa Barbara, Cal. (100)  
KFWO Avalon, Catalina Isl., Cal. (100)  
KGDR San Antonio, Tex. (100)  
KGGH Little Rock, Ark. (100)  
KGGHX Richmond, Tex. (50)  
KGGKB Goldthwaite, Tex. (100)  
KPPJM Prescott, Ariz. (100)  
KUJ Seattle, Wash. (10)  
KWBS Portland, Ore. (15)  
KWTC Santa Ana, Cal. (100)  
WAFD Detroit, Mich. (100)  
WALK Willow Grove, Pa. (50)  
WCBA Allentown, Pa. (100)  
WCLB Brooklyn, N. Y. (100)  
WIBZ Montgomery, Ala. (15)  
WIBW Philadelphia, Pa. (100)  
WKBV Brookville, Ind. (100)  
WKBZ Ludington, Mich. (50)  
WLBX Long Island City, N. Y. (100)  
WLOE Chelsea, Mass. (100)  
WMBM Newport, R. I. (100)  
WMBM Memphis, Tenn. (10)  
WMBQ Brooklyn, N. Y. (100)  
WMES Boston, Mass. (50)  
WMPC Lapeer, Mich. (30)  
WNBF Endicott, N. Y. (50)  
WNBF Rochester, N. Y. (15)  
WOO Philadelphia, Pa. (100)  
WPSW Philadelphia, Pa. (50)  
WRBJ Hattiesburg, Miss. (10)  
WSAN Allentown, Pa. (100)  
WTBO Wilmington, Del. (100)  
WWRL Woodside, N. Y. (100)

**201.2 Meters. 1490 Kilocycles**  
WBAW Nashville, Tenn. (5000)  
WLAC Nashville, Tenn. (5000)

**202.6 Meters. 1480 Kilocycles**  
WJAZ Chicago, Ill. (5000)  
WHT Chicago, Ill. (5000)  
WORD Chicago, Ill. (5000)

**204 Meters. 1470 Kilocycles**  
KFJF Oklahoma City, Okla. (5000)  
KGA Spokane, Wash. (5000)  
WKBW Buffalo, N. Y. (5000)  
WRUF St. Petersburg, Fla. (5000)

**205.4 Meters. 1460 Kilocycles**  
KSTP St. Paul, Minn. (10000)  
WJSV Mt. Vernon Hills, Va. (10000)

**206.8 Meters. 1450 Kilocycles**  
KSBA Shreveport, La. (1000)  
WBMS Union City, N. J. (250)  
WFJC Akron, Ohio (500)  
WIBS Elizabeth, N. J. (250)  
WJAY Cleveland, Ohio (500)  
WKBO Jersey City, N. J. (250)  
WNJ Newark, N. J. (250)  
WSAR Portsmouth, R. I. (250)  
WTFI Toccoa Falls, Ga. (500)

**208.2 Meters. 1440 Kilocycles**  
KLS Oakland, Cal. (100)  
WABF Kingston, Pa. (250)  
WABO Rochester, N. Y. (500)  
WHEG Rochester, N. Y. (500)  
WMBD Peoria Heights, Ill. (500)  
WNRG Greensboro, N. C. (500)  
WOKO Poughkeepsie, N. Y. (500)  
WRAX Philadelphia, Pa. (250)  
WTAD Quincy, Ill. (500)

**209.7 Meters. 1430 Kilocycles**  
WBRL Tilton, N. H. (500)  
WCAH Columbus, Ohio (250)  
WGBB Memphis, Tenn. (500)  
WICC Bridgeport, Conn. (500)  
WMBS Harrisburg, Pa. (500)  
WNBR Memphis, Tenn. (500)

**211.1 Meters. 1420 Kilocycles**  
KFIF Portland, Ore. (50)  
KFIZ Fond du Lac, Wis. (100)  
KFQU Holy City, Cal. (100)

**KFOW** Seattle, Wash. (100)  
**KFXD** Jerome, Ida. (15)  
**KFXV** Flagstaff, Ariz. (100)  
**KFYO** Breckenridge, Tex. (100)  
**KGCN** Concordia, Kans. (50)  
**KGCX** Vida, Mont. (10)  
**KGFJ** Los Angeles, Cal. (100)  
**KGFV** Ravenna, Nebr. (50)  
**KGGF** Picher, Okla. (100)  
**KGHD** Missoula, Mont. (5)  
**KGTT** San Francisco, Cal. (50)  
**KICK** Atlantic, Iowa (100)  
**KKP** Seattle, Wash. (15)  
**KMED** Medford, Ore. (50)  
**KOCW** Chickasha, Okla. (100)  
**KORE** Eugene, Ore. (100)  
**KTAP** San Antonio, Tex. (100)  
**KTUE** Houston, Tex. (5)  
**KXRO** Seattle, Wash. (75)  
**WAAD** Cincinnati, Ohio (25)  
**WEDH** Erie, Pa. (30)  
**WHPP** New York, N. Y. (10)  
**WIAS** Ottumwa, Iowa (100)  
**WIBR** Steubenville, Ohio (50)  
**WIL** St. Louis, Mo. (1000)  
**WKBP** Battle Creek, Mich. (50)  
**WKBT** New Orleans, La. (50)  
**WLBK** Kansas City, Mo. (100)  
**WLBH** Farmingdale, N. Y. (30)  
**WLEX** Lexington, Mass. (100)  
**WMBC** Detroit, Mich. (100)  
**WMBH** Joplin, Mo. (100)  
**WMRJ** Jamaica, N. Y. (10)  
**WQBZ** Weirton, W. Va. (60)  
**WSRO** Middletown, Ohio (100)  
**WSSH** Boston, Mass. (100)  
**WTBO** Cumberland, Md. (50)

**212.6 Meters. 1410 Kilocycles**  
**KFLV** Rockford, Ill. (500)  
**KGRS** Amarillo, Tex. (1000)  
**WDAG** Amarillo, Tex. (1000)  
**WDEL** Wilmington, Del. (500)  
**WDGY** Minneapolis, Minn. (500)  
**WHBL** Sheboygan, Wis. (500)  
**WHDI** Minneapolis, Minn. (500)  
**WSKC** Bay City, Mich. (500)

**214.2 Meters. 1400 Kilocycles**  
**WBAA** West Lafayette, Ind. (500)  
**WBBC** Brooklyn, N. Y. (500)  
**WCGU** Brooklyn, N. Y. (500)  
**WCMA** Culver, Ind. (500)  
**WKBF** Indianapolis, Ind. (500)  
**WLTH** Brooklyn, N. Y. (500)  
**WSDA** Brooklyn, N. Y. (500)  
**WSGH** Brooklyn, N. Y. (500)

**215.7 Meters. 1390 Kilocycles**  
**KFPY** Spokane, Wash. (500)  
**KLRA** Little Rock, Ark. (1000)  
**KOW** Denver, Colo. (500)  
**KUOA** Fayetteville, Ark. (1000)  
**KWSC** Pullman, Wash. (500)  
**WHK** Cleveland, Ohio (1000)

**217.3 Meters. 1380 Kilocycles**  
**KQV** Pittsburgh, Pa. (500)  
**KSO** Clarinda, Iowa (1000)  
**WCSSO** Springfield, Ohio (500)  
**WKBH** LaCrosse, Wis. (1000)

**218.8 Meters. 1370 Kilocycles**  
**KFBL** Everett, Wash. (50)  
**KFEC** Portland, Ore. (100)  
**KFJI** Astoria, Ore. (50)  
**KFJZ** Fort Worth, Tex. (100)  
**KFLX** Galveston, Tex. (100)  
**KFUR** Ogden, Utah (50)  
**KGAR** Tucson, Ariz. (100)  
**KGBX** St. Joseph, Mo. (100)  
**KGCB** Oklahoma City, Okla. (100)  
**KGCI** San Antonio, Tex. (100)  
**KGDA** Dell Rapids, S. Dak. (15)  
**KGER** Long Beach, Cal. (100)  
**KGFG** Oklahoma City, Okla. (50)  
**KGFL** Raton, N. Mex. (50)

**KGGM** Albuquerque, N. Mex. (100)  
**KGKL** Georgetown, Tex. (100)  
**KGRC** San Antonio, Tex. (100)  
**KOH** Reno, Nev. (100)  
**KRE** Berkeley, Cal. (100)  
**KVL** Seattle, Wash. (100)  
**KWKC** Kansas City, Mo. (100)  
**KZM** Oakland, Cal. (100)  
**WBBL** Richmond, Va. (100)  
**WGBM** Baltimore, Md. (100)  
**WEAM** North Plainfield, N. J. (100)  
**WFBJ** Collegeville, Minn. (100)  
**WBBD** Bellefontaine, Ohio (100)  
**WHBQ** Memphis, Tenn. (100)  
**WIAD** Philadelphia, Pa. (100)  
**WIBM** Jackson, Mich. (100)  
**WJBK** Ypsilanti, Mich. (50)  
**WJBO** New Orleans, La. (100)  
**WMBO** Auburn, N. Y. (100)  
**WRKA** Erie, Pa. (50)  
**WRBT** Wilmington, N. C. (50)  
**WSVS** Buffalo, N. Y. (50)

**220.4 Meters. 1360 Kilocycles**  
**KFBB** Havre, Mont. (250)  
**KGB** San Diego, Cal. (250)  
**KGIR** Butte, Mont. (250)  
**WBET** Boston, Mass. (500)  
**WGES** Chicago, Ill. (500)  
**WJKS** Gary, Ind. (500)  
**WMAF** South Dartmouth, Mass. (500)  
**WQBC** Utica, Miss. (300)

**222.1 Meters. 1350 Kilocycles**  
**KGFL** Trinidad, Colo. (50)  
**KWK** St. Louis, Mo. (1000)  
**WBNY** New York, N. Y. (250)  
**WCDA** New York, N. Y. (250)  
**WKBQ** New York, N. Y. (250)  
**WMSG** New York, N. Y. (250)

**223.7 Meters. 1340 Kilocycles**  
**KFPW** Sulphur Springs, Ark. (50)  
**KMO** Tacoma, Wash. (500)  
**KVI** Tacoma, Wash. (1000)  
**WSPD** Toledo, Ohio (500)

**225.4 Meters. 1330 Kilocycles**  
**KSCJ** Sioux City, Iowa (1000)  
**WCAC** Mansfield, Conn. (500)  
**WDRC** New Haven, Conn. (500)  
**WTAQ** Eau Claire, Wis. (1000)

**227.1 Meters. 1320 Kilocycles**  
**KGHF** Pueblo, Colo. (250)  
**KGIO** Idaho Falls, Ida. (250)  
**KGIO** Twin Falls, Ida. (250)  
**WADC** Akron, Ohio (1000)  
**WSMB** New Orleans, La. (750)

**228.9 Meters. 1310 Kilocycles**  
**KFBK** Sacramento, Cal. (100)  
**KFCB** Phoenix, Ariz. (100)  
**KFGQ** Boone, Iowa (10)  
**KFJY** Fort Dodge, Iowa (100)  
**KFPL** Dublin, Tex. (15)  
**KFFM** Greenville, Tex. (15)  
**KFUP** Denver, Colo. (100)  
**KFXJ** Edgewater, Colo. (50)  
**KFXR** Oklahoma City, Okla. (100)  
**KGEZ** Kalispell, Mont. (100)  
**KGFI** San Angelo, Tex. (100)  
**KGGH** Cedar Grove, La. (50)  
**KGHG** McGehee, Ark. (50)  
**KRMD** Shreveport, La. (50)  
**KWCR** Cedar Rapids, Iowa (100)  
**WABY** Philadelphia, Pa. (50)  
**WAGM** Royal Oak, Mich. (50)  
**WBMH** Detroit, Mich. (100)  
**WBOW** Terre Haute, Ind. (100)  
**WBRE** Wilkes-Barre, Pa. (100)  
**WCLS** Joliet, Ill. (100)  
**WDAH** El Paso, Tex. (100)  
**WDEB** Buffalo, N. Y. (100)  
**WEHS** Evanston, Ill. (100)  
**WFBG** Altoona, Pa. (100)  
**WFDF** Flint, Mich. (100)

**WFKD** Philadelphia, Pa. (50)  
**WGAL** Lancaster, Pa. (15)  
**WHBP** Johnstown, Pa. (100)  
**WHFC** Chicago, Ill. (100)  
**WIBU** Poyette, Wis. (100)  
**WJAK** Kokomo, Ind. (50)  
**WKAJ** Laconia, N. H. (50)  
**WKBH** Joliet, Ill. (100)  
**WKBC** Birmingham, Ala. (10)  
**WKBI** Chicago, Ill. (50)  
**WKBS** Galesburg, Ill. (100)  
**WLBC** Muncie, Ind. (50)  
**WLBO** Galesburg, Ill. (100)  
**WMBL** Lakeland, Fla. (100)  
**WNAT** Philadelphia, Pa. (100)  
**WNBH** New Bedford, Mass. (100)  
**WNBK** Knoxville, Tenn. (50)  
**WNEW** Norfolk, Va. (100)  
**WOBT** Union City, Tenn. (15)  
**WRAW** Reading, Pa. (100)  
**WRBI** Tifton, Ga. (20)  
**WRBW** Columbia, S. C. (100)  
**WRK** Hamilton, Ohio (100)  
**WSAJ** Grove City, Pa. (100)  
**WSMD** Takoma Park, Md. (100)  
**WTHS** Atlanta, Ga. (100)

**230.6 Meters. 1300 Kilocycles**  
**KFH** Wichita, Kans. (1000)  
**KFJR** Portland, Ore. (500)  
**KGEF** Los Angeles, Cal. (1000)  
**KTBI** Los Angeles, Cal. (1000)  
**KTBR** Portland, Ore. (500)  
**WBRR** Rossville, N. Y. (1000)  
**WEVD** New York, N. Y. (500)  
**WHAP** New York, N. Y. (1000)  
**WHAZ** Troy, N. Y. (500)  
**WIBW** Topeka, Kans. (1000)

**232.4 Meters. 1290 Kilocycles**  
**KDYL** Salt Lake City, Utah (1000)  
**KFUL** Galveston, Tex. (500)  
**KLCN** Blytheville, Ark. (50)  
**KTSA** San Antonio, Tex. (1000)  
**WJAS** Pittsburgh, Pa. (1000)  
**WNBZ** Saranac Lake, N. Y. (10)

**234.2 Meters. 1280 Kilocycles**  
**KTAB** Oakland, Cal. (500)  
**WCAM** Camden, N. J. (500)  
**WCAP** Asbury Park, N. J. (500)  
**WDAY** Fargo, N. Dak. (1000)  
**WDOD** Chattanooga, Tenn. (1000)  
**WEBC** Superior, Wis. (1000)  
**WOAX** Trenton, N. J. (500)

**236.1 Meters. 1270 Kilocycles**  
**KFOA** Seattle, Wash. (1000)  
**KFUM** Colorado Springs, Colo. (1000)  
**KGCA** Decorah, Iowa (50)  
**KTW** Seattle, Wash. (1000)  
**KWLC** Decorah, Iowa (50)  
**WASH** Grand Rapids, Mich. (250)  
**WDSU** New Orleans, La. (1000)  
**WEAI** Ithaca, N. Y. (500)  
**WOL** Washington, D. C. (150)  
**WOOD** Grand Rapids, Mich. (500)

**238 Meters. 1260 Kilocycles**  
**KOIL** Council Bluffs, Iowa (1000)  
**KRGV** Harlingen, Tex. (500)  
**KWWG** Brownsville, Tex. (500)  
**WJAX** Jacksonville, Fla. (1000)  
**WLBW** Oil City, Pa. (500)

**239.9 Meters. 1250 Kilocycles**  
**KEJK** Los Angeles, Cal. (500)  
**KFMX** Northfield, Minn. (1000)  
**KFON** Long Beach, Cal. (1000)  
**KXL** Portland, Ore. (500)  
**WAAM** Newark, N. J. (500)  
**WCAL** Northfield, Minn. (1000)  
**WGCP** Newark, N. J. (500)  
**WGMS** St. Paul-Minn., Minn. (1000)  
**WLB** Minneapolis, Minn. (1000)  
**WODA** Paterson, N. J. (1000)  
**WRHM** Minneapolis, Minn. (1000)





**483.6 Meters. 620 Kilocycles**  
**KFAD** Phoenix, Ariz. (500)  
**KGW** Portland, Ore. (1000)  
**WDAE** Tampa, Fla. (1000)  
**WDBO** Orlando, Fla. (1000)  
**WLBZ** Dover-Foxcroft, Me. (500)  
**WTMJ** Milwaukee, Wis. (1000)

**491.5 Meters. 610 Kilocycles**  
**KFRC** San Francisco, Cal. (1000)  
**WDAF** Kansas City, Mo. (1000)  
**WFAN** Philadelphia, Pa. (500)  
**WIP** Philadelphia, Pa. (500)  
**WOO** Kansas City, Mo. (1000)

**499.7 Meters. 600 Kilocycles**  
**KFBU** Laramie, Wyo. (500)  
**KFSD** San Diego, Cal. (500)  
**WCAO** Baltimore, Md. (250)

**WEBW** Beloit, Wis. (250)  
**WOAN** Lawrenceburg, Tenn. (500)  
**WREC** Memphis, Tenn. (500)

**508.2 Meters. 590 Kilocycles**  
**KHQ** Spokane, Wash. (1000)  
**WCAJ** Lincoln, Nebr. (500)  
**WEEI** Boston, Mass. (500)  
**WEMC** Berrien Springs, Mich. (1000)  
**WOW** Omaha, Nebr. (1000)

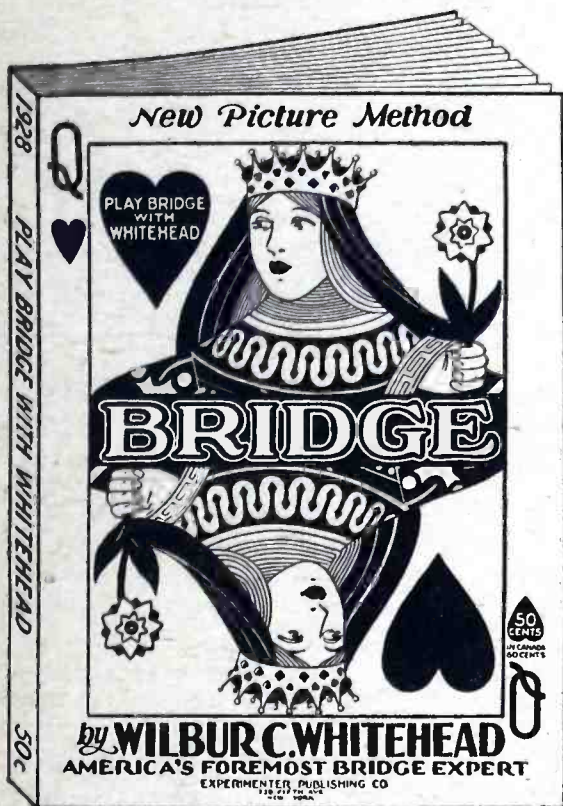
**516.9 Meters. 580 Kilocycles**  
**KGFF** Alva, Okla. (500)  
**KGFX** Pierre, S. Dak. (200)  
**KSAC** Manhattan, Kans. (500)  
**WOBU** Charleston, W. Va. (250)  
**WSAZ** Huntington, W. Va. (250)  
**WSUI** Iowa City, Iowa (500)  
**WTAG** Worcester, Mass. (250)

**526 Meters. 570 Kilocycles**  
**KGKO** Wichita Falls, Tex. (250)  
**KMTR** Hollywood, Cal. (1000)  
**KPLA** Los Angeles, Cal. (1000)  
**KUOM** Missoula, Mont. (500)  
**KXA** Seattle, Wash. (500)  
**WHA** Madison, Wis. (750)  
**WIBO** Chicago, Ill. (5000)  
**WKBN** Youngstown, Ohio (500)  
**WMAC** Cazenovia, N. Y. (500)  
**WMCA** New York, N. Y. (500)  
**WNAX** Yankton, S. Dak. (500)  
**WNYC** New York, N. Y. (500)  
**WPCC** Chicago, Ill. (500)  
**WSMK** Dayton, Ohio (200)  
**WSYR** Syracuse, N. Y. (250)  
**WWNC** Asheville, N. C. (1000)

**535.4 Meters. 560 Kilocycles**  
**KFDM** Beaumont, Tex. (500)  
**KFEQ** St. Joseph, Mo. (2500)

**KLZ** Denver, Colo. (1000)  
**KOAC** Corvallis, Ore. (1000)  
**WFI** Philadelphia, Pa. (500)  
**WFLA** Clearwater, Fla. (1000)  
**WLIT** Philadelphia, Pa. (500)  
**WMBF** Miami Beach, Fla. (500)  
**WNOX** Knoxville, Tenn. (1000)  
**WOI** Ames, Iowa (3500)  
**WSUN** St. Petersburg, Fla. (1000)

**545.1 Meters. 550 Kilocycles**  
**KFDY** Brookings, S. Dak. (500)  
**KFJM** Grand Forks, N. Dak. (500)  
**KFUO** St. Louis, Mo. (500)  
**KFYR** Bismarck, N. Dak. (500)  
**KSD** St. Louis, Mo. (500)  
**WEAN** Providence, R. I. (500)  
**WEAO** Columbus, Ohio (750)  
**WGR** Buffalo, N. Y. (750)  
**WKRC** Cincinnati, Ohio (500)



WILBUR C. WHITEHEAD'S  
 new "Picture Method" teaches  
**BRIDGE**  
*easily and quickly*

Printed in 2 COLORS :: Red and Black Cards

WILBUR C. WHITEHEAD, the world-renowned bridge expert, has written this interesting instruction course for you. *BRIDGE by Whitehead* is unique in that it teaches the entire game of bridge by a new and original form of illustration known as Whitehead's

"PICTURE METHOD." Every hand is illustrated, each card in its proper color, red or black, as the case may be. Thus the beginner, or even the most seasoned player, has an actual illustration of the manner in which the play is made always before him.

Whitehead, whose reputation as the foremost authority, national or international, on the game of bridge, is one whose advice cannot be taken lightly; he knows the game as few others know it. In this book he passes on to his readers, in an easily understandable fashion, his picture method—that made him a success.

Get your copy of *BRIDGE by Whitehead* today—100 pages—9" x 12" size. Beautiful colored cover. Each point illustrated.

**50c** THE COPY

At all Newstand or write direct  
**EXPERIMENTER PUBLISHING COMPANY, Inc.**  
 230 Fifth Avenue, New York, N. Y.

EXPERIMENTER PUBLISHING CO.  
 230 Fifth Avenue  
 New York, N. Y.

GENTLEMEN:  
 Enclosed find 50 cents, for which please send me a copy of *BRIDGE by Whitehead*.

Name.....  
 Address.....  
 City..... State.....





# Canadian Radio Broadcast Stations

Indexed Alphabetically by Call Letters

Radio Call Letters	BROADCAST STATIONS Location and Owner	Power (Watts)	Wave Length (Meters)	Frequency (Kilo-cycles)	Time at Station	Radio Call Letters	BROADCAST STATIONS Location and Owner	Power (Watts)	Wave Length (Meters)	Frequency (Kilo-cycles)	Time at Station
<b>CFAC</b>	—Calgary, Alberta — The Calgary Herald, Herald Bldg.	500	434.5	690	Mountain	<b>CHGS</b>	—Summerside, P.E.I. —R. T. Holman, Ltd., Holman Bldg.	25	267.7	1120	Atlantic
<b>CFBO</b>	—St. John, N. B.—C. A. Munro, Ltd., Imperial Theatre, King Square.	50	336.9	890	Atlantic	<b>CHLS</b>	—Vancouver, B. C.—W. G. Hassell (Uses Station CKCD).	50	410.7	730	Pacific
<b>CFCA</b>	—Toronto, Ont. — Star Publishing & Printing Co., S. W. Cor. Yonge St. and St. Clair Ave.	500	356.9	840	Eastern	<b>CHMA</b>	—Edmonton, Alberta— Christian and Missionary Alliance, 9618—106A Ave.	250	516.9	580	Mountain
<b>CFCF</b>	—Montreal, Que.—Canadian Marconi Co., Mount Royal Hotel.	1650	410.7	730	Eastern	<b>CHML</b>	—Mt. Hamilton, Ont.— Maple Leaf Radio Co., Ltd., Yale Ave.	50	340.7	880	Eastern
<b>CFCH</b>	—Iroquois Falls, Ont.— Abitibi Power & Paper Co., Ltd.	250	499.7	600	Eastern	<b>CHNC</b>	—Toronto, Ont. — Toronto Radio Research Society, Hillcrest Park (Uses Station CKNC).	500	516.9	580	Eastern
<b>CFCN</b>	—Calgary, Alberta — W. W. Grant (Ltd.), 708 Crescent Rd., N. W.	1800	434.5	690	Mountain	<b>CHNS</b>	—Halifax, Nova Scotia— Northern Electric Co., Carleton Hotel, Cor. Prince and Argyle Sts. (New 500 Watt Station under construction).	500	322.4	930	Atlantic
<b>CFCO</b>	—Chatham, Ont.—Western Ontario "Better Radio" Club, 49 Park Ave E.	25	247.8	1210	Eastern	<b>CHRC</b>	—Quebec, Que. — E. Fontaine, 46 Palace Hill.	5	340.7	880	Eastern
<b>CFCT</b>	—Victoria, B. C.—Victoria Broadcasting Assoc., 1405 Douglas St.	500	475.9	630	Pacific	<b>CHWC</b>	—Regina, Sask.—R. H. Williams & Sons, Ltd., Cor. Hamilton St. and 11th Ave.	500	312.3	960	Mountain
<b>CFCY</b>	—Charlottetown, P. E. Island—Island Radio Company, 143 St. George St.	100	312.3	960	Atlantic	<b>CHWK</b>	—Chilliwack, B. C. — Chilliwack Broadcasting Co., Ltd., Wellington Ave.	5	247.8	1210	Pacific
<b>CFJC</b>	—Kamloops, B. C.—N. S. Dalgleish & Sons and Weller & Weller, 186 Victoria St.	15	267.7	1120	Pacific	<b>CHYC</b>	—Montreal, Que. — Northern Electric Co., Ltd., 121 Shearer St.	750	410.7	730	Eastern
<b>CFLC</b>	—Prescott, Ont. — Radio Association of Prescott, Victoria Hall.	50	296.9	1010	Eastern	<b>CJBC</b>	—Toronto, Ont.—Jarvis Street Baptist Church (Uses one of the stations in Toronto City or District).	500 1000 5000	516.9 356.9 312.3	580 840 960	Eastern
<b>CFMC</b>	—Kingston, Ont.—Monarch Battery Co., Montreal St.	20	267.7	1120	Eastern	<b>CJBR</b>	—Regina, Sask. — Saskatchewan Co-Operative Wheat Producers, Ltd. (Uses Station CKCK).	500	312.3	960	Mountain
<b>CFNB</b>	—Fredericton, N. B. — James S. Neill & Sons, Limited, 212 Waterloo Row.	50	247.8	1210	Atlantic	<b>CJCA</b>	—Edmonton, Alberta — The Edmonton Journal, Ltd., Journal Bldg.	500	516.9	580	Mountain
<b>CFQC</b>	—Saskatoon, Sask.—The Electric Shop, Ltd., 1322 Osler St.	500	329.5	910	Mountain	<b>CJCJ</b>	—Calgary, Alberta — Radio Service and Repair Shop, 18th Ave. and 7th St., E.	250	434.5	690	Mountain
<b>CFRB</b>	—York Co., Ont. — Standard Radio Mfg. Corp., Ltd., Township of King.	1000	312.3	960	Eastern	<b>CJGC</b>	—London, Ont. — London Free Press Printing Co., Ltd., Hotel London.	500	329.5	910	Eastern
<b>CFRC</b>	—Kingston, Ont. — Queen's University, Dept. of Electrical Engineering, Fleming Hall.	500	267.7	1120	Eastern	<b>CJGX</b>	—Yorkton, Sask. — The Winnipeg Grain Exchange.	500	475.9	630	Mountain
<b>CHCA</b>	—Calgary, Alberta — The Albertan Publishing Co., Ltd. (Uses Station CJCJ).	250	434.5	690	Mountain	<b>CJHS</b>	—Saskatoon, Sask. — Radio Service, Ltd., 238—1st Ave S.	250	329.5	910	Mountain
<b>CHCK</b>	—Charlottetown, P. E. Island—W. E. Burke, 36 Upper Hillsboro St.	30	312.3	960	Atlantic	<b>CJOC</b>	—Lethbridge, Alberta — J. E. Palmer, 1235—5th Ave. A, South.	50	267.7	1120	Mountain
<b>CHCS</b>	—Hamilton, Ont. — The Hamilton Spectator, Spectator Bldg.	10	340.7	880	Eastern						
<b>CHCT</b>	—Red Deer, Alberta — G. F. Tull & Ardern, Ltd. (Uses Station CKLC).	1000	356.9	840	Mountain						

Radio Call Letters	BROADCAST STATIONS Location and Owner	Power (Watts)	Wave Length (Meters)	Frequency (Kilo-cycles)	Time at Station	Radio Call Letters	BROADCAST STATIONS Location and Owner	Power (Watts)	Wave Length (Meters)	Frequency (Kilo-cycles)	Time at Station
<b>CJOR</b>	Sea Island, B. C.—Geo. C. Chandler, Block 20.	50	291.1	1030	Pacific	<b>CKOW</b>	Toronto, Ont.—Nestle's Food Co. of Canada. (Uses Station CFCFA).	500	356.9	840	Eastern
<b>CJRM</b>	Moose Jaw, Sask.—Jas. Richardson & Sons, Ltd., 337 Coteau St., W.	500	296.9	1010	Mountain	<b>CKPC</b>	Preston, Ont.—Wallace Russ, 40 Russ Ave.	25	247.8	1210	Eastern
<b>CJRW</b>	Fleming, Sask.—Jas. Richardson & Sons, Ltd.	500	296.9	1010	Mountain	<b>CKPR</b>	Midland, Ont.—E. O. Swan.	50	267.7	1120	Eastern
<b>CJRX</b>	Winnipeg, Man.—Jas. Richardson & Sons, Ltd., Grain Exchange Bldg.	2000	256.3	1170	Central	<b>CKSH</b>	St. Hyacinthe, Que.—City of St. Hyacinthe, Que., Mondor and Cascades St.	50	296.9	1010	Eastern
<b>CJSC</b>	Toronto, Ont.—The Evening Telegram (Uses Station CKCL).	500	516.9	580	Eastern	<b>CKUA</b>	Edmonton, Alberta—University of Alberta.	500	516.9	580	Mountain
<b>CKAC</b>	Montreal, Que.—La Presse Publishing Co., Ltd., Cor. St. James St. and St. Lawrence Blvd.	1200	410.7	730	Eastern	<b>CKWX</b>	Vancouver, B. C.—A. Holstead & W. Hanlon, 1220 Seymour St.	100	410.7	730	Pacific
<b>CKCD</b>	Vancouver, B. C.—Vancouver Daily Province, 142 Hastings St., W.	50	410.7	730	Pacific	<b>CKX</b>	Brandon, Man.—Manitoba Telephone System, 8th St.	500	555.6	540	Central
<b>CKCI</b>	Quebec, Que.—Le "Soleil", Ltd., 46 Palace Hill.	22½	340.7	880	Eastern	<b>CKY</b>	Winnipeg, Manitoba—Manitoba Telephone System, Sherbrooke St.	5000	384.4	780	Central
<b>CKCK</b>	Regina, Sask.—Leader Publishing Co., Ltd.	500	312.3	960	Mountain	<b>CNRA</b>	Moncton, N. B.—Canadian National Railways.	500	475.9	630	Atlantic
<b>CKCL</b>	Toronto, Ont.—Dominion Battery Co., Ltd., 20 Trinity St. (Call signal CFCL used during Sunday broadcasts only).	500	516.9	580	Eastern	<b>CNRC</b>	Calgary, Alberta—Canadian National Railways (Uses Station CFAC).	500	434.5	690	Mountain
<b>CKCO</b>	Ottawa, Ont.—Dr. G. M. Geldert (for Ottawa Radio Assoc.), 282 Somerset St., W.	100	434.5	690	Eastern	<b>CNRE</b>	Edmonton, Alberta—Canadian National Railways (Uses Station CJCA).	500	516.9	580	Mountain
<b>CKCR</b>	Brantford, Ont.—John Patterson, Arcade Bldg.	50	296.9	1010	Eastern	<b>CNRM</b>	Montreal, Que.—Canadian National Railways (Uses Stations, CHYC, CKAC and CFCF).	1000-1650	410.7	730	Eastern
<b>CKCV</b>	Quebec, Que.—G. A. Vandry, 66 St. Joseph St.	50	340.7	880	Eastern	<b>CNRO</b>	Ottawa, Ont.—Canadian National Railways, Jackson Bldg.	500	434.5	690	Eastern
<b>CKFC</b>	Vancouver, B. C.—United Church of Canada, Cor. Thurlow and Pendrell Sts.	50	410.7	730	Pacific	<b>CNRO</b>	Quebec, Que.—Canadian National Railways (Uses Station CKCV).	50	340.7	880	Eastern
<b>CKGW</b>	Bowmanville, Ont.—Gooderham & Worts.	5000	312.3	960	Eastern	<b>CNRR</b>	Regina, Sask.—Canadian National Railways (Uses Station CKCK).	500	312.3	960	Mountain
<b>CKLC</b>	Red Deer, Alberta—Alberta Pacific Grain Co., Ltd.	1000	356.9	840	Mountain	<b>CNRS</b>	Saskatoon, Sask.—Canadian National Railways (Uses Station CFQC).	500	329.5	910	Mountain
<b>CKMC</b>	Cobalt (East Side), Ont.—R. L. MacAdam.	15	247.8	1210	Eastern	<b>CNRT</b>	Toronto, Ont.—Canadian National Railways (Uses Station CFCFA).	500	356.9	840	Eastern
<b>CKMO</b>	Vancouver, B. C.—Sprott-Shaw Radio Co., Bekins Bldg.	50	410.7	730	Pacific	<b>CNRV</b>	Vancouver, B. C.—Transmitter is on Lulu Island, —Canadian National Railways.	500	291.1	1030	Pacific
<b>CKNC</b>	Toronto, Ont.—Canadian National Carbon Co., Ltd., Hillcrest Park.	500	516.9	580	Eastern	<b>CNRW</b>	Winnipeg, Manitoba—Canadian National Railways (Uses Station CKY).	500	384.4	780	Central
<b>CKOC</b>	Hamilton, Ont.—Wentworth Radio and Auto Supply Co., Ltd., Royal Connaught Hotel.	100	340.7	880	Eastern						

# Canadian Radio Broadcast Stations

## By Provinces and Cities

Provinces	Cities	Call Letters	Wave Length (Meters)	Power (Watts)
<b>ALBERTA</b>	Calgary	CFAC	434.5	500
"	Calgary	CFCN	434.5	1800
"	Calgary	CHCA	434.5	250
"	Calgary	CJCJ	434.5	250
"	Calgary	CNRC	434.5	500
"	Edmonton	CHMA	516.9	250
"	Edmonton	CJCA	516.9	500
"	Edmonton	CKUA	516.9	500
"	Edmonton	CNRE	516.9	500
"	Lethbridge	CJOC	267.7	50
"	Red Deer	CHCT	356.9	1000
"	Red Deer	CKLC	356.9	1000
<b>BRITISH COLUMBIA</b>	Chilliwack	CHWK	247.8	5
"	Kamloops	CFJC	267.7	15
"	Sea Island	CJOR	291.1	50
"	Vancouver	CHLS	410.7	50
"	Vancouver	CKCD	410.7	50
"	Vancouver	CKFC	410.7	50
"	Vancouver	CKMO	410.7	50
"	Vancouver	CKWX	410.7	100
"	Vancouver	CNRV	291.1	500
"	Victoria	CFCT	475.9	500
<b>MANITOBA</b>	Winnipeg	CJRX	256.3	2000
"	Winnipeg	CKX	555.6	500
"	Winnipeg	CKY	384.4	5000
"	Winnipeg	CNRW	384.4	500
<b>NEW BRUNSWICK</b>	Fredericton	CFNB	247.8	50
"	Moncton	CNRA	475.9	500
"	St. John	CFBO	336.9	50
<b>NOVA SCOTIA</b>	Halifax	CHNS	322.4	500
<b>ONTARIO</b>	Bowmanville	CKGW	312.3	5000
"	Brantford	CKCR	296.9	50
"	Chatham	CFCO	247.8	25
"	Cobalt	CKMC	247.8	15
"	Hamilton	CHCS	340.7	10
"	Hamilton	CKOC	340.7	100
"	Iroquois Falls	CFCH	499.7	250
"	Kingston	CFMC	267.7	20
"	Kingston	CFRC	267.7	500
"	London	CJGC	329.5	500
"	Midland	CKPR	267.7	50
"	Mt. Hamilton	CHML	340.7	50
"	Ottawa	CKCO	434.5	100
"	Ottawa	CNRO	434.5	500
"	Prescott	CFLC	296.9	50
"	Preston	CKPC	247.8	25
"	Toronto	CFCA	356.9	500
"	Toronto	CHNC	516.9	500
"	Toronto	CJBC	516.9-356.9-312.3	500-1000-5000
"	Toronto	CJSC	516.9	500
"	Toronto	CKCL	516.9	500
"	Toronto	CKNC	516.9	500
"	Toronto	CKOW	356.9	500
"	Toronto	CNRT	356.9	500
"	York Co.	CFRB	312.3	1000

Provinces	Cities	Call Letters	Wave Length (Meters)	Power (Watts)
<b>P. E. ISLAND</b>	<b>Charlottetown</b>	<b>CFCY</b>	312.3	100
"	<b>Charlottetown</b>	<b>CHCK</b>	312.3	30
"	<b>Summerside</b>	<b>CHGS</b>	267.7	25
<b>QUEBEC</b>	<b>Montreal</b>	<b>CFCF</b>	410.7	1650
"	<b>Montreal</b>	<b>CHYC</b>	410.7	750
"	<b>Montreal</b>	<b>CKAC</b>	410.7	1200
"	<b>Montreal</b>	<b>CNRM</b>	410.7	1000-1650
"	<b>Quebec</b>	<b>CHRC</b>	340.7	5
"	<b>Quebec</b>	<b>CKCI</b>	340.7	22½
"	<b>Quebec</b>	<b>CKCV</b>	340.7	50
"	<b>Quebec</b>	<b>CNRQ</b>	340.7	50
"	<b>St. Hyacinthe</b>	<b>CKSH</b>	296.9	50
<b>SASKATCHEWAN</b>	<b>Fleming</b>	<b>CJRW</b>	296.9	500
"	<b>Moose Jaw</b>	<b>CJRM</b>	296.9	500
"	<b>Regina</b>	<b>CHWC</b>	312.3	500
"	<b>Regina</b>	<b>CJBR</b>	312.3	500
"	<b>Regina</b>	<b>CKCK</b>	312.3	500
"	<b>Regina</b>	<b>CNRR</b>	312.3	500
"	<b>Saskatoon</b>	<b>CFQC</b>	329.5	500
"	<b>Saskatoon</b>	<b>CJHS</b>	329.5	250
"	<b>Saskatoon</b>	<b>CNRS</b>	329.5	500
"	<b>Yorkton</b>	<b>CJGX</b>	475.9	500

**Licenses Required for Both Transmitters and Receivers in Canada**

All radio stations, whether used for transmitting or receiving purposes are required to be licensed in Canada. The penalty on summary conviction for operating an unlicensed radio station is a fine not exceeding \$50.00, and on conviction or indictment a fine not exceeding \$500.00, with imprisonment for a term not exceeding 12 months, in addition to forfeiture of all unlicensed apparatus. The different classes of stations for which licenses are issued and their license fees vary from \$1.00 for a private receiving set to \$50.00 for a public commercial station.

The issue of licenses for transmitting stations is limited to British subjects or to companies incorporated under the laws of the Dominion of Canada or its provinces. Licenses for private receiving sets are issued to any person irrespective of nationality. Licenses for receiving sets are obtained from the Postmaster of the larger towns and cities in the Dominion, radio dealers, Royal Canadian Mounted Police, Department of Radio Inspectors, Departmental Agencies or from the Department of Marine and Fisheries. Licenses for all other classes of stations are obtained from the Department of Marine and Fisheries at Ottawa.

**A NEW SERVICE TO OUR READERS**

Fill out the coupon below and mail it to Editor, Radio Listeners' Guide & Call Book, 230 Fifth Ave., New York. We will put you on our mailing list and you will receive at different times, without cost, a list containing all changes which the Federal Radio Commission may make from time to time, enabling you thus to keep all your Broadcast Station lists up-to-date.

**Editor, Radio Listeners' Guide & Call Book**  
**230 Fifth Ave., N. Y.**

My name is.....

My occupation is.....

My address is.....

My town and state.....

**Please put me on your free list to receive bulletin of changes made by the Radio Commission.**

# Foreign Radio Broadcast Stations

Including U. S. Possessions

Countries, Cities and Owners	Call Letters	Wave Length (Meters)	Power (Watts)	Countries, Cities and Owners	Call Letters	Wave Length (Meters)	Power (Watts)
<b>ALASKA</b>				Sydney—Trades Hall Broadcasting Station.....	2KY	280	1500
Anchorage—Anchorage Radio Club	KFQD	243.8	100	Sydney—Farmer & Co., Ltd.....	2FC	442	5000
Juneau—Alaska Elec. Light & Power Co.	KFIU	228.9	10	Sydney.....	2WA	462	100
Ketchikan—Alaska Radio & Service Co.	KGBU	333.1	500	Sydney—Broadcasters Sydney Ltd.....	2BL	358	5000
<b>ALGERIA</b>				Sydney—Otto Sandel.....	2UW	267	500
Algiers—Colin & Fils.....	8DB	310	2000	Toowomba—Gold Radio Elec. Service..	4GR	294	100
<b>ARGENTINE</b>				Wagga—Otto Sandel.....	2UX	300	500
Buenos Aires.....	LOJ	270	1000	<b>AUSTRIA</b>			
Buenos Aires—Radio America	LOL	236	2000	Graz—Oesterreichische Radio-verkehrs Gesellschaft.....		357.1	500
Buenos Aires—Radio Fenix.....	LON	210	5000	Innsbruck.....		294.1	500
Buenos Aires—Radio Prieto.....	LOO	252	1000	Klagenfurt.....		272.7	1500
Buenos Aires—Radio Buenos Aires.....	LOQ	261	500	Vienna—Oesterreichische Radio-verkehrs Gesellschaft.....	ORV	577	750
Buenos Aires—Sociedad Radio Argentina.....	LOR	344.8	1000	Vienna.....		517.2	20000
Buenos Aires—Municipality of Buenos Aires.....	LOS	291.2	5000	<b>BELGIUM</b>			
Buenos Aires—Radio Broadcasting.....	LOT	400	1000	Brussels—Radio Belgique Co.....	BAV	508.5	1500
Buenos Aires—Francisco J. Brusa.....	LOV	361.5	1000	Brussels—Radio Belgique Co.....	SBR	481	1500
Buenos Aires—Grand Splendid.....	LOW	303	1000	<b>BOLIVIA</b>			
Buenos Aires—Radio Cultura.....	LOX	380	1000	La Paz.....		175-300	50
Buenos Aires—Sociedad Radio Nacional	LOY	315.8	1000	La Paz.....		300	50
Buenos Aires—"La Nacion".....	LOZ	330	1000	<b>BRAZIL</b>			
Buenos Aires—Gino Bocci y Hno.	B2	275	100	Bahia—Radio Sociedade de Bahia.....	SQAD	350	50
Buenos Aires.....	D3	253.3	100	Bello Horizonte—Radio Sociedade de Mina Geraes.....		400	500
Cordoba—Antonio Vanelli.....	H5	275	100	Ceara—Radio Club Cearense.....			50
Cordoba—Diario "Los Principios".....	H6	250	20	Curytiba—Livio Moreira.....			300
La Plata, FCS.—Universidad Nacional.	LOP	425	1000	Fortazela—Radio Club.....			300
Mendoza—Ministerio de Obras Publicas	LOU	380	500	Goyanna—Benedicto Ravello.....			300
Rosario—Manuel Fugardo.....	F2	270	100	Juiz de Fora.....	SQAY	380	200
Santa Fe—Jose Roca Soler.....	F1	279	20	Matto Grosso—Radio Club de Campo Grande.....			100
<b>AUSTRALIA</b>				Minas Geraes—Luiz de Fora.....			100
Adelaide—Central Broadcasters Ltd.....	5CL	395	5000	Para—Radio Club de Para.....			100
Adelaide—5 DN Pty. Ltd.....	5DN	313	500	Parana.....		370	300
Adelaide—Sports Radio Broadcasting Station.....	5KA	250	1000	Parahyba—Radio Sociedade de Parahyba.....			
Adelaide—Millswood Auto & Radio Co.....	5MA			Pelotas—Radio Sociedade Pelotense.....			
Adelaide—Marshall & Co.....	5MC	273	500	Penedo—A. G. Oliveira.....			
Bathurst—Mockler Bros.....	2MK	275	250	Pernambuco—Radio Club de Pernambuco.....		310	1000
Brighton.....	3PB			Pernambuco—Cia Radiotelegrafica Brasileira.....		250-380	500
Brisbane—Dr. V. McDowell.....	4CM	278	250	Pernambuco—Radio Sociedade de Jader de Andrada.....			
Brisbane—Radio Manufacturers Ltd.....	4MB	337	250	Pernambuco—Radio Sociedade de Garanhuns.....			
Brisbane—Queensland Radio Service.....	4QG	385	5000	Petropolis—Radio Club de Petropolis.....			
Hobart—Tasmanian Broadcasting Pty.....	7ZL	516	3000	Porto Alegre—Radio Sociedade Rio-grandense.....	RSR	381	80
Melbourne—Associated Radio Co.....	3AR	481	3000	Praia Vermelha—Radio Club do Brasil.....	SQIB	320	500
Melbourne—Druleigh Business & Technical College.....	3DB	225	500	Rio de Janeiro—Radio Sociedade de Rio de Janeiro.....	SQAA	400	2000
Melbourne—Broadcasting Co. Australia	3LO	371	5000	Rio de Janeiro.....	SQAB	320	500
Melbourne—O. J. Nilson & Co.....	3UZ	319	100	Rio de Janeiro.....	SQAJ	260	250
Melbourne—L. J. Hellier.....	3WR	303	100	Sao Paulo.....	SQAG	365	1000
Mildura—R. J. Egge.....	3EO	286	100	Sao Paulo.....	SQBO	225.4	1000
Newcastle—H. A. Douglas.....	2HD	288	100	Sorocaba.....		425	....
Northbridge—Otto Sandel.....	2UW	263	500				
Perth—Westralian Farmers, Ltd.....	6WF	1250	3000				
Rockhampton—Queensland Gov't.....	4RN	323	500				
Sydney—The Electrical Utilities Supply Co.....	2UE	293	250				
Sydney—Burgin Electric Co.....	2BE	316	100				
Sydney—Theosophical Broadcasting Service.....	2GB	316	3000				



Countries, Cities and Owners	Call Letters	Wave Length (Meters)	Power (Watts)	Countries, Cities and Owners	Call Letters	Wave Length (Meters)	Power (Watts)
<b>CANARY ISLANDS</b>				<b>Havana—Julio Power</b> .....			
La Laguna—Servando Ortoll Delmotte	EAJ5	280	50	Havana—Frederick W. Borton	2JP	312	30
Las Palmas—Canary Islands Radio Club		300	6	Havana—Alberto S. Bustamante	2CX	320	10
Teneriffe—Servando Ortoll Delmotte	EAR5	350	200	Havana—Cuban Telephone Co.	2AB	250	10
<b>CEYLON</b>				Havana—Jose Leiro	PWX	400	500
Colombo		800	1500	Havana—Alvara Daza	2JL	275	5
<b>CHILE</b>				Havana—E. Sanchez de Fuentes	2K	200	20
Antofagasta—Sr. J. Pedreny	CHAO			Havana—“El Pais”	2KD	350	50
Concepcion	CMAI	345	1500	Havana—Bernardo Barrie	2EP	355	400
Santiago—“El Mercurio”	CMAC	360	1200	Havana—Frederick W. Borton	2BB	250	15
Santiago—Castagneto Felli	CMAD	320	1000	Havana—Jose Lara	2BY	260	100
Santiago—Radio Comercial	CMAE	280	100	Havana—Manuel y Guillermo Salas	2LR	215	15
Santiago—Sociedad Broadcasting de Chile	CRC	385	350	Havana—R. B. Waters	2MG	284	15
Tacna—Ministerio de Relaciones Exteriores	CMAT	550	200	Havana—R. B. Waters	2MK	32	100
Tacna—Chilean Government	CRCT	550	200	Havana—Mario Garcia Velez	2OK	360	100
Temuco	CMAK	245	100	Havana—Oscar Collado	2OL	257	100
Valparaiso		400	50	Havana—Roberto E. Ramirez	2TW	270	30
<b>CHINA</b>				Havana—Benito Veita Ferro	2UF	265	20
Hong Kong—Government	GOW	300	1500	Havana—Raul Karman	2RK	315	100
Kharbin—Chinese Government	COHB	340	50	Havana—Homero Sanchez	2SZ	180	10
Mukden	COMK	425	2000	Havana—Miguel Troncoso	2WX	340	150
Peking—Chinese Government	COPK			Havana—Lecuona Music Co.	2XA	230	200
Shanghai—Kellogg Switchboard & Supply Co.	KRC	335	150	Havana—Raul Perez Falcon	2JD	105	20
Shanghai—Shinsho Co.	NKS	318	50	Havana—Heraldo de Cuba	2HC	275	500
Tientsin—Gisho Electric Co.	GEC	288	50	Hershey—Alberto Alvarez	2FG	200	20
Tientsin—Chinese Government	COTN	480	500	Marianao—Jose L. Ferriol	2JF	245	5
Victoria (Hongkong)—Hongkong Radio Society	5HK	475	150	Marianao—Jose Leiro	2JL	294	5
<b>CHOSEN</b>				Marianao—Modesto Alvarez	2MA	215	50
Seoul	JODK	345	1000	Marianao—Samuel I. Wheeldon	2WD	274	7½
<b>COSTA RICA</b>				Mariano—Antonio A. Genard	2XX	225	5
San Jose—Government				Nueva Gerona—Isle of Pines Telephone Co.	8JQ	130	20
<b>CUBA</b>				Sagua la Grande—Santiago Ventura	6HS	200	10
Caibarien—Maria J. Alvarez	6EV	250	50	Sancti Spiritus—Antonio Galguera	6KP	250	20
Caibarien—Manuel A. Alvarez	6LO	325	250	Santiago—Alfredo Vinnel	8FU	225	15
Camaguey—Pedro Noguerras	7AZ	225	10	Santiago—Pedro C. Anduz	8DW	275	50
Camaguey Armanda Vaquer	7GT	195	5	Santiago—Alfredo Broock Galo	8AZ	240	50
Camaguey—Melchor Aguero	7KP	300	15	Santiago—Ceferino Ramos	8IR	190	20
Camajuani—Diego Iborra	6YR	200	20	Santiago—Alberto Ravelo	8BY	250	20
Caney—Juan Fdez. de Castro	8KP	30	100	Santiago—Guillermo Polanco	8HS	200	30
Caney	8LO	300	100	<b>CZECHOSLOVAKIA</b>			
Central Elia—Salvador Rionda	7SR	350	500	Bratislava	OKR	300	500
Central Tuinucu—Frank H. Jones	6KW	368	100	Brunn—Radio Journal	OKB	441.2	3000
Central Tuinucu—Frank H. Jones	6JK	272	100	Kbely		1100	1000
Ciego de Avila—Eduardo V. Figueroa	7BY	235	20	Koszice (Kassa)		1870	5000
Ciego de Avila—Feliciano Isaac	7FU	200	15	Prague—Radio Journal	OKP	348.9	5000
Ciego de Avila—Porfirio de la Cruz	7HS	192	15	<b>DANZIG</b>			
Florida—Leonard B. Fox	7JQ	42	5	Danzig		272.7	750
Cienfuegos—Jose Ganduxe	6BY	260	200	<b>DENMARK</b>			
Cienfuegos—Eduardo Terry	6DW	225	10	Copenhagen—Copenhagen Radio Broadcasting Station		337	1000
Cienfuegos—Gustavo Rodriguez	6GR	150	10	Kalundborg		1153.8	7500
Cienfuegos—Juan Pablo Ros	6GT	190	50	Ryvang		1150	1000
Colon—Leopoldo V. Figueroa	5EV	360	100	Soro—Ministry of War		1153.8	1500
Guanajay—Antonio Zarazola	1AZ	275	30	<b>EGYPT</b>			
Havana—Ulpiano Muniz	2MU	265	10	Cairo	SRE	255	
Havana—Casimiro Pujadas	2CP	280	10	<b>ESTONIA</b>			
Havana—Cristina W. Vda. de Cruet	2HP	205	200	Tallinn		408	2200
				Tallinn		1200	100
				<b>FINLAND</b>			
				Bjorneborg—Nuoren Voiman Liiton Radiohydistsys		311	200
				Hango—Nuoren Voiman Liiton Radiohydistsys		260	250

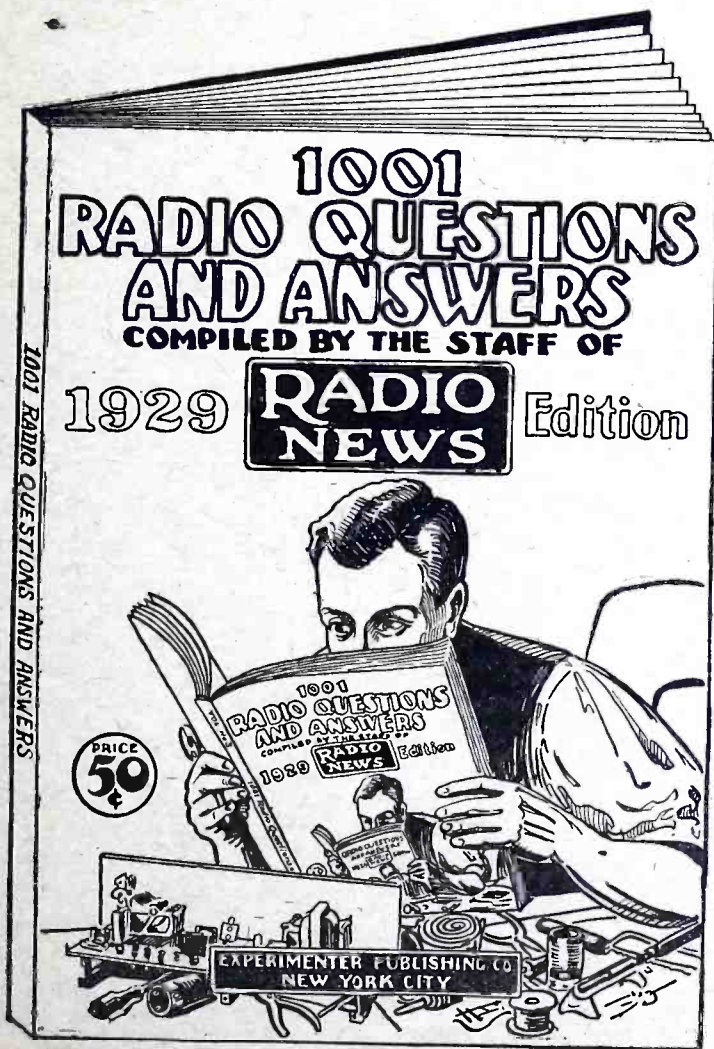
Countries, Cities and Owners	Call Letters	Wave Length (Meters)	Power (Watts)	Countries, Cities and Owners	Call Letters	Wave Length (Meters)	Power (Watts)
<b>FINLAND</b>				<b>Dortmund</b> —Westdeutsche Funkstunde.		283	750
Helsingfors—Civil Guards of Finland.		375	1200	<b>Dresden</b> —Mitteldeutscher Rundfunk.		275.2	700
Jacobstad.		275.2	200	<b>Elberfeld</b> —Westdeutsche Funkstunde.		468.8	750
Jyvaskyla—Nuoren Voiman Liiton Radiohydists.		297	250	<b>Frankfort-on-the-Main</b> —Sudwestdeutscher Rundfunkdienst.	LP	428.6	4000
Lahti.		1522	20000	<b>Freiburg im Breisgau</b> —Suddeutscher Rundfunk.		574.7	750
Mikkeli—Nuoren Voiman Liiton Radiohydists.		566	250	<b>Gleiwitz</b> —Schlesische Funkstunde.		250	750
Pori—Nuoren Voiman Liiton Radiohydists.		255.3	100	<b>Hamburg</b> —Nordischer Rundfunk.	HA	394.7	4000
Skatudden—Military Station Radio Div.		318	750	<b>Hanover</b> —Nordischer Rundfunk.		297	750
St. Michel—Nuoren Voiman Liiton Radiohydists.		566	250	<b>Kassel</b> —Sudwestdeutscher Rundfunk.		272	750
Tammerfors—Nuoren Voiman Liiton Radiohydists.	3NB	400	250	<b>Kiel</b> —Nordischer Rundfunk.		254.2	750
Tampere.		373	250	<b>Koenigsberg</b> —Ostmarken Rundfunk.		329.7	4000
Uleaborg.		250	250	<b>Langenberg</b> .	LA	468.8	25000
Viborg.		214.3	750	<b>Leipzig</b> —Mitteldeutscher Rundfunk.	MR	365.8	4000
				<b>Munich</b> —Deutsche Stunde in Bayern.		535.7	4000
				<b>Muenster</b> —Westdeutsche Funkstunde.	MS	241.9	1500
				<b>Norddeich</b> .	KAV	1829	
				<b>Nuremberg</b> —Deutsche Stunde in Bayern.		303	4000
				<b>Stettin</b> —Funkstunde A. G.		236.2	500
				<b>Stuttgart</b> —Suddeutscher Rundfunk.	OKP	379.7	4000
<b>FRANCE</b>				<b>HAITI</b>			
Agen—Dept. of Lot et Garonne.	2BD	297	250	<b>Port-au-Prince</b> —Haitien Government.	HHK	361.2	1000
Angers—Radio Anjou.		275.2	500	<b>HAWAII</b>			
Beziere.		158	500	<b>Honolulu</b> —Radio Sales Co.	KGHB	227.1	250
Biarritz—Cote d'Argent.		200	250	<b>Honolulu</b> —Honolulu Advertiser.	KGU	319	500
Bordeaux.		275	1000	<b>HUNGARY</b>			
Bordeaux.		238.1	1500	<b>Budapest</b> —Hungarian States' Post and Telegraph.	MTI	555.6	20000
Dijon.		207.5	1000	<b>Budapest</b> —Magyar Tavirati Iroda.		1050	2000
Grenoble—Ministry of P. T. T.		588.2	1500	<b>ICELAND</b>			
Issy-les-Moulineaux—Ministry of War	QGA	1800	500	<b>Reykjavik</b> .		333.3	1000
Juan-les-Pins.		230	500	<b>INDIA</b>			
Lille.		287	500	<b>Bangalore</b> —Indian Broadcasting Co.			
Limoges.		273	500	<b>Bombay</b> —Walter Rogers & Co.	2AX	226	
Lyon—Ministry of P. T. T.	YN	476	1000	<b>Bombay</b> .	7BY	357.1	3000
Lyon—Radio Lyon.		291.3	1500	<b>Bombay</b> —Bombay Residency Radio Club.	2FV	375	220
Marseilles—Ministry of P. T. T.		309	500	<b>Calcutta</b> —Radio Club of Bengal.	2BZ	800	500
Mont-de-Marsan—Radio Club Landrais.		400	4000	<b>Calcutta</b> —Indian States & Eastern Agency.	5AF	425	1500
Montpellier—Societe Languedocienne de T. S. F.		252.1	250	<b>Calcutta</b> .	7CA	370.4	3000
Paris—Ecole Superieure de P. T. T.	FPTT	464	500	<b>Karachi</b> —Karachi Radio Club.		425	40
Paris—Eiffel Tower, Army.	FL	1400	5000	<b>Madras</b> —Crampton Elec. Co.		220	120
Paris—Societe Francaise Radioelectrique	8AJ	1780	100	<b>Madras</b> —Madras Presidency Club.	2GR	400	200
Paris—Lucien Levy.		350	250	<b>Rangoon</b> —Radio Club of Burmah.	2HZ	350	350
Paris—Petit Parisien.	5NG	340.9	500	<b>IRISH FREE STATE</b>			
Paris—Cie. Francaise de Radiophone.		1750	6000	<b>Cork</b> .	6CK	400	1500
Paris—Radio Paris.	CFR	1765	12000	<b>Dublin</b> —Government.	2RN	319.1	1500
Paris—Radio Vitus.		308	1000	<b>ITALY</b>			
Pic du Midi.		350		<b>Milan</b> .		547.4	7000
Reims.		204.1	500	<b>Milan</b> —Unione Radiofonica Italiana.	IMI	315.8	1500
Reziere.		178	500	<b>Naples</b> —Unione Radiofonica Italiana.	INA	333.3	1500
St. Etienne—Radio Club Forezien.		220	50	<b>Nice</b> .		362	1000
Strasbourg—Military Station Radio Club.	8GF	222.2	250	<b>Rome</b> —Unione Radiofonica Italiana.	IRO	450	3000
Toulouse—Aerodrome.	MRD	260	1000	<b>JAPAN</b>			
Toulouse—La Radio.		391	3000	<b>Hiroshima</b> —Broadcasting Corp. of Japan.	JOFK	353	10000
<b>GERMANY</b>				<b>Keijo</b> —Keijo Broadcasting Association.	JODK	366	1000
Aix-la-Chapelle.		401	750				
Augsburg.		566	1500				
Berlin—Koenigswusterhausen Deutsche Welle A. G.	AFP	2900	8000				
Berlin—Koenigswusterhausen Station.	AFT	1250	35000				
Berlin—Vox Haus Funkstunde.	AB	566	2000				
Berlin—Witzleben Funkstunde A. G.		483.9	4000				
Berlin—Wolff's Bureau.		2525	5000				
Bremen—Nordischer Rundfunk.	BMN	400	1500				
Breslau—Schlesische Funkstunde.		322.6	5000				
Cologne.	SMXO	283	4000				

Countries, Cities and Owners	Call Letters	Wave Length (Meters)	Power (Watts)	Countries, Cities and Owners	Call Letters	Wave Length (Meters)	Power (Watts)
<b>JAPAN</b>				<b>NEW ZEALAND</b>			
Kumamoto—Broadcasting Corp. of Japan.....	JOGK	380	10000	Auckland—Newcomb (Ltd.).....	1YL	260	500
Nagoya—Broadcasting Corp. of Japan..	JOCK	370	1000	Auckland—The Radio Broadcasting Co. of New Zealand.....	1YA	333	500
Osaka—Broadcasting Corp. of Japan...	JOBK	385-400	10000	Auckland—La Gloria Gramophone Co..	1YB	275	50
Sapporo—Broadcasting Corp. of Japan	JOIK	361	10000	Auckland—L. R. Keith.....	IZO	330	50
Sendai—Broadcasting Corp. of Japan..	JOHK	396	10000	Christchurch—Radio Broadcasting Co. of New Zealand.....	3AC	240	10
Tokyo—Broadcasting Corp. of Japan...	JOAK	345-375	10000	Christchurch—Radio Broadcasting Co. of New Zealand.....	3YA	306	500
<b>JAVA</b>				Dunedin—Otago University.....	4XO	140	
Batavia—Bataviasche Radio Vereeninging.....	JFC	220	40	Dunedin—Radio Broadcasting Co. of New Zealand.....	4YA	463	750
<b>KWANTUNG</b>				Dunedin—Radio Supply Co.....	4YO	370	500
Dairen—Government Bureau of Communications.....	JOAK	395	5000	Dunedin—Radio Broadcasting Co.....	VLDN	380	750
<b>LATVIA</b>				Gisborne—Gisborne Radio Co.....	2YM	260	500
Riga.....	KCX	526.3	2000	Napier—B. C. Spackman.....	2YL	190	100
<b>LITHUANIA</b>				Wellington—Broadcastings Ltd.....	2YB	275	15
Kovno.....		2000	15000	Wellington—Radio Broadcasting Co. of New Zealand.....	2YA	420	5000
<b>LUXEMBURG</b>				Whangerei—N. C. Shepherd.....	1YC	250	15
Luxemburg.....	LOAA	217.4	250	<b>NORWAY</b>			
<b>MEXICO</b>				Bergen—Bergen Broadcasters.....		370.4	1500
Chihuahua—Federal Government.....	CZF	310	250	Fredrikstad—Broadcasting Co. A. S.....		434.8	750
Guadalajara—Federal Military Command.....	FAM	490	1000	Hamar—Broadcasting Co. A. S.....		566	750
Mazatlan—Castulo Llamas.....	CYR	475	250	Natodden—Broadcasting Co. A. S.....		423	700
Merida—Partido Socialista del Surestan	CYY	549	100	Oslo—Broadcasting Co. A. S.....	OSLO	461.5	1500
Mexico City—Efran R. Gomez.....	CYA	300	500	Porsgrund—Broadcasting Co. A. S.....		524	1000
Mexico City—Jose J. Reynosa (El Buen Tono).....	CYB	275	500	Rjuken—Broadcasting Co. A. S.....		443	250
Mexico City—Miguel S. Castro (La High Life).....	CYH	375	100	Stavanger.....		277.8	250
Mexico City—General Electric Co.....	CYJ	400	2000	Tromso—Tromso Broadcasters.....		500	
Mexico City—"El Universal".....	CYL	400	500	Trondhjem.....		243.9	
Mexico City—Martinez y Zetina.....	CYO	425	100	<b>PARAGUAY</b>			
Mexico City—Excelsior Compania Editorial.....	CYX	325	500	Asuncion.....			12
Mexico City—Departamento de Educacion	CZE	350	500	<b>PERU</b>			
Monterey—D. Constantino de Tarnava, Jr.....	CYH			Lima—Peruvian Broadcasting Co.....	OAX	360	1500
Monterey—Constantino de Tarnava....	CYS	311	250	<b>PHILIPPINE ISLANDS</b>			
Oaxaca—Federico Zonilla.....	CYF	265	100	Baguio.....	KZUY	359.9	500
Puebla—Augustin del P. Saenz.....	CYU	312	100	Iloilo.....	KPM	400	500
Tampico.....	CYQ	322	100	Manila—Radio Corp. of the Philippines	KZIB	260	500
Torreón.....	CYM	225	1500	Manila—Radio Corp. of the Philippines	KZKZ	270	500
Vera Cruz—Ministerio de Comunicaciones.....	CYC	337	50	Manila—Radio Corp. of the Philippines	KZRM	413	1000
Vera Cruz.....	CYD			Manila—Radio Corp. of the Philippines	KZRQ	400	1000
<b>MOROCCO</b>				<b>POLAND</b>			
Casablanca—Radio Club de Moroc....	CNO	305	2500	Cracow.....		567	1500
<b>NETHERLANDS</b>				Kattowitz.....		422	10000
Amsterdam.....		760		Posen.....		344.8	1500
Bloemendaal.....		566		Vilna.....		435	500
De Bilt.....	PCFF	1100	1250	Warsaw—Government.....	PTR	380	700
Eindhoven—Phillips Lamp Works.....	PCJJ	30.2	1950	Warsaw.....	AXO	1111.1	8000
Huizen.....				<b>PORTO RICO</b>			
Hilversum—Nederlandische Seintoellen Fabriek.....	HDO	1060	5000	San Juan—Radio Corp. of Porto Rico..	WKAQ	516.9	500
Scheveningen.....		1950	2500	<b>PORTUGAL</b>			
<b>NETHERLANDS EAST INDIES</b>				Lisbon—Grandes Armazens do Chiado..	PIAA	267.8	500
Soeabaya—Radiotelegraph Club.....		90		Montesanto—Government Wireless Station.....	CTV	2450	1500
				<b>SAN SALVADOR</b>			
				San Salvador—Government of el Salvador.....	AQM	482	500
				<b>SENEGAL</b>			
				St. Louis—Senegal Radio Club.....		300	100

Countries, Cities and Owners	Call Letters	Wave Length (Meters)	Power (Watts)	Countries, Cities and Owners	Call Letters	Wave Length (Meters)	Power (Watts)
<b>SIBERIA</b>				<b>Stockholm—The Swedish Broadcasting Co.</b>	<b>SASA</b>	454.5	1500
Tomsk	RA21	300	250	Sundsvall—Radiotjanst	SASD	545.8	800
<b>SPAIN</b>				Trolhattan — Trolhattans Rundradio-station	SMXQ	277.8	1000
Almeria	EAJ18	323.8	1000	Uddevalla	SMZP	294.1	250
Barcelona—Radio Barcelona (Hotel Colon)	EAJ1	344.8	1500	Umea	SMSN	229	250
Barcelona—Radio Catalana	EAJ13	277.6	1000	Uppsala		500	250
Bilbao—Radio Club Vizcaina	EAJ9	436	1000	Varborg	SMSO	297	250
Bilbao—Radio Vizcaya	EAJ11	418	2000				
Bilbao—Armando de Otera		383	200	<b>SWITZERLAND</b>			
Cadiz—Radio Cadiz	EAJ3	400	500	Basle	HB3	1000	250
Cadiz—Radio Lahera	EAJ10	297	1000	Berne—Radio—Genossenschaft	HBA	411	1500
Cartagena—Enrique de Orbe	EAJ16	335	1000	Geneva—Radio Broadcasting Soc. of Geneva	HBI	760	500
Cartagena	EBX	1200	1000	Lausanne—Lausanne Radio Society	HB2	680	600
Madrid—Radio Espana	EAJ2	393	3000	Zurich—Zurich University	RGZ	515-650	500
Madrid—Escuela Superior	PTT	458	1000	Zurich—Zurich Radio Genossenschaft	HBZ	500	1000
Madrid—Antonio Castilla	EAJ4	375	6000				
Madrid—Radio Iberica	EAJ6	392	1000	<b>TUNISIA</b>			
Madrid—Union Radio	EAJ7	373	1500	Carthage	TNV	1850	5000
Madrid	EAJ12	306	2000	Carthage		1840	4000
Madrid—Radio Espanola	EAJ15	490	1000	Tunis—French Army	OCTU-TUA	1450-45	500
Madrid	EGC	1650-2200	2000				
Malaga—Spanish Telecommunication Co.	EAJ25	325	1000	<b>TURKEY</b>			
Malaga—Alfonso Villota		325	200	Angora		1800	6000
Oviedo (Cima)—Arturo Cima Fernandez	EAJ19	340	100	Osmanieh—Broadcasting Co.		1200	6000
Salamanca	EAJ22	405	1000	Stamboul		1800	15000
San Sebastian—Sabino Ucelayeta	EAJ8	335	500				
Sevilla—Manuel Garcia Ballesta	EAJ17	400	1000	<b>UNION OF SO. AFRICA</b>			
Sevilla—Jorge la Riva	EAJ21	300	1000	Cape Town—African Broadcasting Assn.	WAMG	375	1500
Sevilla—Radio Club Sevillano	EAJ5	344.8	1000	Durban—Town Council		400	1500
Valencia	EAJ24	360	1000	Johannesburg — African Broadcasting Co.	JB	450	500
Valencia—Jose Lopez Aznar	EAJ14	500	500				
Zaragoza	EAJ23	325	1500	<b>UNION OF SOVIET SOCIALIST REPUBLICS (formerly Russia)</b>			
<b>STRAITS SETTLEMENTS</b>				Astrakhan	RA26	700	1000
Singapore—Malaya Amateur Wireless Society		330	150	Baku	RA45	760	1250
<b>SWEDEN</b>				Bogorodsk	RA8	750	
Boden—Radiotjanst	SASE	1200	1000	Ekaterinburg	RA15	750	250
Boras	SMBY	230.8	1000	Homel	RA39	925	1250
Eskilstuna—Radio Club	SMUC	250	250	Irkutsk		1300	
Falun—Radiotjanst	SMZK	357	2000	Ivanovo Voznesensk	RA7	800	1000
Gaevle—Radio Club	SMXF	204.1	250	Kharkov	RA43	640	4000
Goteborg—Radiotjanst	SASB	416.7	1000	Kharkov	RA24	475	4000
Halmstad	SMSB	215.8	250	Kiev	RA5	775	1000
Helsingborg	SMYE	229	250	Kniepropetrovsk		560	1000
Hudiksvall	SMSL	272.7	250	Krasnodar	RA38	513	1000
Jonkopings—Jonkopings Rundradiostation	SMZD	201.3	500	Leningrad	RA6	940	2000
Kalmar	SMSD	254.2	250	Leningrad	RA42	1000	10000
Kalmar	SMSW	252.1	250	Minsk	RA18	950	1250
Karlsborg—Radiotjanst	SASF	1350	50	Moscow—Sokolniki		1010	2000
Karlsborg	SAJ	1365	5000	Moscow—Trade Union	KAZ	450	2000
Karlskrona	SMSM	196	250	Moscow—Lubovitch		365	
Karlstadt—Radio Club of Karlstad	SMXG	221	250	Moscow	MSK	650	2000
Karlstadt	SMXZ	221	250	Moscow—Union of Soviet Workers	RA4	675	500
Kiruna		238.1	250	Moscow—Kominern	RDW	1450	40000
Kristinehamn	SMTY	202.7	250	Moscow—Radio-Peredatcha	RAI	420	2000
Linkoeeping—Radio Club	SMUV	588.2	250	Niji-Novgorod	RA13	1400	1500
Linkoeeping	SMUW	497.5	250	Novosibirsk	RA33	700	4000
Malmo—Radiotjanst	SASC	260.9	1000	Odessa	RA40	1000	1250
Motala		1380	20000	Rostov-on-Don	RA14	820	1250
Norrkoeping—Radio Club	SMVV	275.2	250	Saratoff		700	1000
Orebro	SMTI	236.2	250	Sevastopol	RA9	800	1000
Ostersund		720	2000	Stavropol	RA20	655	1250
Saffle	SMTS	252.1	500	Tashkent	RA27	800	4000
				Tiflis		870	4000

Countries, Cities and Owners	Call Letters	Wave Length (Meters)	Power (Watts)	Countries, Cities and Owners	Call Letters	Wave Length (Meters)	Power (Watts)
<b>UNION OF SOVIET SOCIALIST REPUBLICS (formerly Russia)</b>				<b>Liverpool—British Broadcasting Corp....</b>			
Tver.....	RA44	965	1250	London—British Broadcasting Corp....	6LV	297	200
Ust-Syssolsk.....	REG	1000	1250	Manchester—British Broadcasting Corp.	2LO	361.4	2000
Veliky-Ustjuk.....	RA16	1010	1250	Newcastle—British Broadcasting Corp...	2ZY	384.6	1000
Vladivostok.....	RA17	456	1250	Nottingham—British Broadcasting Corp.....	5NO	312.5	1000
Vladivostok—Union of Soviet Worker's Radio Club.....	RL20	480	1500	Plymouth—British Broadcasting Corp....	5NG	275.2	200
Voronesh.....	RA12	950	1250	Sheffield—British Broadcasting Corp....	5PY	400	200
<b>UNITED KINGDOM</b>				Stroke-on-Trent—British Broadcasting Corp.....	6FL	272.7	200
Aberdeen—British Broadcasting Corp....	2BD	306.1	1000	Swansea—British Broadcasting Corp.....	6ST	294.1	200
Belfast—British Broadcasting Corp....	2BE	500	1000	<b>URUGUAY</b>			
Bournemouth—British Broadcasting Corp.....	6BM	326.1	1000	Montevideo—Diario "El Dia".....	CWOR	350	500
Bradford.....	2LS	252.1	200	Montevideo—Danree & Cia.....	CWOF	300	100
Cardiff—British Broadcasting Corp.....	5WA	353	1000	Montevideo—Templo Metodista.....	CWOG	280	10
Chelmsford—British Broadcasting Corp.	5SW			Montevideo—General Electric Co. of Uruguay.....	CWOS	380	500
Daventry (Experimental).....	5GB	491.8	25000	<b>VENEZUELA</b>			
Daventry—British Broadcasting Corp....	5XX	1562.5	25000	Caracas—Empresa Venezolana de Radio-telefonía.....	AYRE	375	1000
Dundee—British Broadcasting Corp.....	2DE	294.1	200	<b>YUGOSLAVIA</b>			
Edinburgh—British Broadcasting Corp....	2EH	288.5	200	Agram (Zagreb).....		310	350
Glasgow—British Broadcasting Corp.....	5SC	405.4	1000	Belgrade—Cie. Generalle De T.S.F.....	HFF	225.6	1000
Hull—British Broadcasting Corp.....	6KH	294.1	200				
Leeds—British Broadcasting Corp.....	2LS	277.8	200				

# FANS! third big edition —



Completely Revised Up-to-the-Minute  
Compiled by the Staff of RADIO NEWS

1001 RADIO QUESTIONS AND ANSWERS, the most sensational seller in the radio field, is now in its third new and revised edition. No one interested in radio should be without a copy. The staff of RADIO NEWS, the leading fan magazine, has striven to make 1001 RADIO QUESTIONS AND ANSWERS the foremost work of its kind available. There is a full and complete explanation of every worthwhile circuit that has appeared since the beginning of radio, not only the explanation, but also complete diagrams from which the set can be constructed. Concise, authentic answers to every question that can possibly be asked concerning the many and varied branches of radio reception on both short-wave and broadcast bands.

FANS! Don't hesitate! Get your copy today:  
Over 112 pages—fully illustrated—large magazine size

**50c** THE COPY

Ask Your Newsdealer or Write Direct to

EXPERIMENTER PUBLISHING CO.  
230 Fifth Avenue  
New York, N. Y.

GENTLEMEN:

Enclosed find 50 cents, for which please send me a copy of "1001 RADIO QUESTIONS AND ANSWERS."

Name.....

Address.....

City..... State.....

**EXPERIMENTER PUBLISHING COMPANY, Inc.**  
230 Fifth Avenue, New York, N. Y.

# SHORT-WAVE RADIO STATIONS OF THE WORLD

Operating on Wavelengths Below 100 Meters

Stations by Call Letters

Call Letters	Stations and Location	Wave Length (Meters)	Remarks	Call Letters	Stations and Location	Wave Length (Meters)	Remarks
<b>AFI</b>	Konigswusterhausen	26.3		<b>FAMJ</b>	French SS. Jeane d'Arc (French Navy)	26-60	
<b>AFJ</b>	Konigswusterhausen	53.5		<b>FL</b>	Eiffel Tower	54.02, 32.0, 75.0	
<b>AFK</b>	Doberi, †2 (Berlin)	45.3, 42.12, 41.5		<b>FTJ</b>	SS. Jacques Cartier (France)	75.0	
<b>AFL</b>	Hamburg	52.0, 70.0		<b>FW</b>	St. Assize, Cie. Radio, France	14.28, 23.25, 25.0, 41.95, 43.0	Traffic with Buenos Aires
<b>AFU</b>	Konigswusterhausen	39.7		<b>FUA</b>	Bizerta-Sidi-Abdallah, Tunis	42.5, 56.0, 73.0	
<b>AGA</b>	Nauen	14.9, 12.25, 13.5, 14.25, 16.0, 26.0		<b>FUE</b>	Mengam, France	38.5	
<b>AGB</b>	Nauen	25.5, 26.6, 27.0	Phone occasionally.	<b>FUL</b>	Beyrouth-Djedeide, Lebanon	28.0, 80.0	
<b>AGC</b>	Nauen	17.2, 26.0, 39.8, 40.2	Phone after 1800 G.M.T.	<b>FUM</b>	Montebourg (Air Station)	37.0	
<b>AGJ</b>	Nauen	56.7		<b>FUT</b>	Toulon-Mourillon, France	36.5	
<b>AGK</b>	Nauen	11.0, 20.0 (2 kw.)		<b>F 8AV</b>	Nogent, France	80.0	
<b>AJN</b>	Casablanca, Ain Bordja	51.0	Weather reports, 0830 & 1930 G.M.T.	<b>F 8GA</b>	Clichy	30.0	
<b>AKA</b>	German Naval Vessel, M.81	54.0		<b>F 8GB</b>	St. Assize, Paris (S.F.R.)	75.0	S.F.R. Bulletins Phone
<b>AKB</b>	German Naval Vessel, M.82	54.0		<b>F 8GC</b>	Radio LL, Paris	60.0	
<b>ANC</b>	Tjililin, Java	26.2, 40.2	Code	<b>F 8KR</b>	Constantine, Algeria	42.8	
<b>AND</b>	Tjililin, Java	18.8, 28.8, 37.5	Code	<b>GBH</b>	Grimsby (Beam Station)	25.906	
<b>ANDIR</b>	Malabar, Java (Military Aerodrome)	38.5	Code and Phone	<b>GBI</b>	Grimsby (Beam, Indian Circuit)	16.216, 34.168	
<b>ANE</b>	Bandoeng, Java	19.93	Code	<b>GBJ</b>	Bodmin (Beam, S. Africa Circuit)	16.146, 34.013	
<b>ANF</b>	Tjililin, Java	20.3, 36.5	Code	<b>GBK</b>	Bodmin (Beam Station)	16.574, 32.397	
<b>ANH</b>	Malabar, Java	17.4, 27.0, 32.0	Code. Phone Sat. 1200-1700 G.M.T. Exp. Tests	<b>GBL</b>	Leafield (P. O. Station)	17.5, 21.5, 24.0, 30.0, 56.0	
<b>ANK</b>	Malabar, Java	19.4, 30.20		<b>GBM</b>	Leafield (P. O. Station)	17.5, 21.5, 24.0, 30.0, 56.0	
<b>AQE</b>	SS. Sir James Clark Ross	33.5		<b>GBO</b>	Leafield (P. O. Station)	17.5, 21.5, 24.0, 30.0, 56.0	
<b>ARCX</b>	Norwegian Whaler Nielsen Alonso	30.5	After 0700 G.M.T.	<b>GDKB</b>	SS. Dorsetshire	24.0, 41.7	
<b>ARDI</b>	SS. C. A. Larsen	32.0		<b>GFA</b>	Air Ministry, London	44.0	
<b>AYG</b>	Guayra, Venezuela	31.8		<b>GFR</b>	Winchester (R.A.F. School)	20.0	
<b>A 2FC</b>	Sydney, N. S. W.	32.0	Phone	<b>GFY</b>	Royal Air Force, Henlow	76.0	
<b>A 2ME</b>	Sydney, Australia	28.50	Phone Sun., 1830-2000 G.M.T.	<b>GLG</b>	Royal Air Force, Henlow	15.740, 15.707	
<b>A 3LO</b>	Melbourne	29.8, 32 or 36	Phone Sun., 1830-2030 G.M.T.	<b>GLH</b>	Dorchester (Beam Station)	22.091	U.S. Circuit
<b>BAM</b>	Tahiti	40.0		<b>GLQ</b>	Ongar (for communication with New York, Buenos Aires, and Rio de Janeiro)	24.5	
<b>BVJ</b>	R. N. College, Dartmouth	46.0		<b>GLS</b>	Ongar	15.0	
<b>BWW</b>	Gibraltar, North Front (Naval Station)	35.0		<b>GLSQ</b>	SS. Olympic	20.0	
<b>BXW</b>	Seletar, Singapore (Naval)	35.0		<b>GLW</b>	Dorchester (Beam Station, South American Circuit)	15.707	
<b>BXY</b>	Stonecutters Island, Hong-Kong	35.0		<b>GLYX</b>	SS. Derbyshire	37.0	
<b>BYB</b>	Whitehall R. C. (Naval)	35.0		<b>G 2BR</b>	Chelmsford	15.0, 17.0	
<b>BYC</b>	Horsea (Naval)	35.0		<b>G 2NM</b>	G. Marcuse, Caterham	32.5	Phone Tues., Thurs., Sat., Sun., 0600-0700, and Sun., 1600-1800 G.M.T.
<b>BYZ</b>	Rinella, Malta (Naval)	35.0		<b>G 2YT</b>	Poldhu	25.0, 32.0, 60.0, 92.0, 94.0	
<b>BZC</b>	Portsmouth Signal School	35.5		<b>G 5DH</b>	Dollis Hill (P. O. Station)	21.7, 27.6, 35.3, 47.0	
<b>BZE</b>	Matara, Ceylon (Naval)	35.0		<b>G 5SW</b>	Chelmsford (B.B.C. Exp.)	24.0	Phone 1330, 1430, and 1930 onwards
<b>BZF</b>	Aden (Naval)	35.0		<b>HBC</b>	Berne, Switzerland	34.2	
<b>B82</b>	Uccle, Belgium	40.0		<b>HJG</b>	Bogotá, Colombia	22.0	
<b>CF</b>	Drummondville, Montreal (Beam Station)	32.0	Temporary	<b>HVA</b>	Hanoi, Tonkin	32.0	
<b>CG</b>	Drummondville, Montreal	16.501, 32.128		<b>HZA</b>	Saigon	25.0	
<b>CH</b>	Quilicura, Chile	15-20		<b>H 90C</b>	Telegraphic and Radio Service, Case No. 63, Poste Transit, Berne	32.0	Relays, Berne Mon., Thurs. and Sat., 2000-2100
<b>CJRX</b>	Winnipeg, Man.	25.60		<b>H 9XD</b>	Radio Club of Zurich	32.0, 85.0	
<b>CRHA</b>	Lourenco Marques, Portuguese East Africa	18.360		<b>IAA</b>	Iwatsuki	40.0	
<b>CRHB</b>	Praia, Cape Verde Islands	18.094		<b>ICC</b>	Coltano	18.0	
<b>CRHC</b>	Loanda, Angola	18.182		<b>ICD</b>	Rome (Cento Celle)	63.0	
<b>DCP</b>	SS. Cap Polonio (German)	25.0, 34.0		<b>ICF</b>	Messina, Sicily	49.0	
<b>DNSC</b>	Royal Danish Dockyard Copenhagen	47.0		<b>ICJ</b>	Bengasi, Cyrenaica	26.0, 53.0	
<b>DS</b>	H.M.S. Renown	36.0		<b>ICK</b>	Tripoli	45.0	
<b>EAM</b>	Madrid	30.7		<b>ICO</b>	Derna, Cyrenaica	54.0	
<b>EAR 55</b>	Barcelona	22.30					
<b>EATH</b>	Vienna	37.00					
<b>EB 4A2</b>	Brussels	42.00					
<b>EH 90C</b>	Berne	32.00					
<b>EH 9XD</b>	Zurich	85.00					
<b>EK 4ZZZ</b>	Dantzig	40.00					

Call Letters	Stations and Location	Wave Length (Meters)	Remarks	Call Letters	Stations and Location	Wave Length (Meters)	Remarks
<b>ICU</b>	Tobruk, Cyrenaica	54.0		<b>KQS</b>	Lone Pine, Calif. (City of Los Angeles)	45.77	
<b>ICX</b>	Massawa	47.0		<b>KQT</b>	Los Angeles, Calif. (City of Los Angeles)	45.77	
<b>IDO</b>	Rome, San Paulo	33.0-37.5		<b>KRP</b>	Salt Lake City, Utah (Western Air Express, Inc.)	49.5	
<b>IDX</b>	Amara, Erythrea	32.5, 64.0		<b>KSS</b>	Bolinas, Calif. (R.C.A.)	14.40, 28.80	
<b>IHF</b>	Catania, Italy	53.5		<b>KSZ</b>	McCamey, Texas	48.05	
<b>IST</b>	Chisimaio, It. Somaliland	38.0		<b>KTA</b>	Guam (Mackay R. & T. Co.)	18.0, 21.8, 22.0, 23.5, 36.0, 43.6, 44.0, 47.0	
<b>I 1AX</b>	Rome, Via Savoia 80	45.0	Phone occasionally	<b>KTF</b>	Midway Island (Mackay R. & T. Co.)	21.6, 33.2, 43.2, 66.4	
<b>I 1AY</b>	Rome	45.00		<b>KUN</b>	Bolinas, Calif. (R.C.A.)	16.93, 33.88	
<b>I 1EA</b>	Rome	40.20		<b>KUY</b>	Bear Creek, Alaska	82.0	
<b>I 1FC</b>	Royal Frederico Cesi School, Rome	33.0, 34.0		<b>KVR</b>	Las Vegas, Nev. (Western Air Express, Inc.)	49.5	
<b>I 1MA</b>	Rome, Via Bramante 3	43	Sun., 1700-1930 G.M.T.	<b>KWE</b>	Bolinas, Calif. (R.C.A.)	14.08, 28.15	
<b>I 1RG</b>	"Radiogiornale," Lake Como	10.0, 18.0, 35.0, 65.0		<b>KWJ</b>	Portland, Ore.	53.54	1/4 kw.
<b>JB</b>	Johannesburg	32.0	Phone	<b>KWT</b>	Palo Alto, Calif. (Fed. Telegraphic Co.)	34.86, 48.05, 49.97, 58.10	
<b>JBK</b>	Kagoshima, Japan	30.0, 40.5, 70.0		<b>KWV</b>	Bakersfield (Pacific Air Transport)	66.48	
<b>JES</b>	Osaka, Japan	24-71		—	Lyons, Radio Lyon	39.5	Phone 1700-1800 G.M.T. except Sun.
<b>JEW</b>	Osaka, Japan	24-71		<b>LA1E</b>	Meteorological Hut, Bergen	43.0	
<b>JFAV</b>	Taipeh, Formosa	39.5	0900 G.M.T.	<b>LA1M</b>	Meteorological Inst., Oslo	45.0	
<b>JHBB</b>	Ibarakiken	37.50		<b>LCHO</b>	Telegraph Administration, Oslo	33.0	
<b>JHL</b>	Hiroshima, Japan	32.0, 58.0, 74.0	Temporary	<b>LPI</b>	Buenos Aires	34.0	
<b>JKV</b>	Kanasawa, Japan	37.5		<b>LPZ</b>	Buenos Aires	36.0, 75.0	
<b>JKZB</b>	Tokyo Electric Co.	20.5		<b>LY</b>	Bordeaux, Lafayette	32.0	
<b>JOC</b>	Otchishi, Japan	43.0		—	Matagora (Spain), Cie. Transatlantic Espagnola	70.0	
<b>JPP</b>	Tokyo, Japan	16-73		<b>NAA</b>	Washington	24.9, 37.4, 74.7	
<b>JPS</b>	Sapporo, Japan	29.0, 38.0, 60.0		<b>NAJ</b>	Great Lakes, Illinois	40.0, 76.0, 34.0	
<b>JYB</b>	Tokyo, Japan	16-73		<b>NAL</b>	Navy Yard, Washington, D. C.	20.0, 30.6	
<b>JYZ</b>	Tokyo, Japan	16-73		<b>NAS</b>	Pensacola, Florida	40.0	
<b>J 1AA</b>	Iwatsuki, Japan	40.5		<b>NBA</b>	Balboa, Canal Zone	54.0	
<b>J 1PP</b>	Tokyo	20.0, 21.5, 35.0		<b>NEL</b>	Lakehurst, N. J.	80.0	
<b>KAV</b>	Norddeich	39.0, 68.0		<b>NEPQ</b>	U. S. SS. Relief	20.0	
<b>KDKA</b>	East Pittsburgh, Pa. (Westinghouse E. & M. Co.)	26.3, 42.95, 62.5	Phone from 2300 G.M.T.	<b>NERM</b>	U. S. SS. Los Angeles	70.0-84.5	
<b>KDO</b>	SS. Esparta (United Fruit Co. U. S. A.)	33.0		<b>NFV</b>	U. S. Marine Corps, Quantico, Va.	77.4, 77.5	
<b>KDZ</b>	Point Barrow, Alaska	21.4, 42.08, 74.77		<b>NIRX</b>	U. S. SS. Canopus	75.0	
<b>KEB</b>	Oakland, Calif. (G. E. Co.)	18.62, 21.8		<b>NKF</b>	Naval Lab., Bellevue, Anacostia	16.0, 17.0, 20.8, 21.0, 25.5, 41.3, 54.4, 61.0, 71.3, 81.5	
<b>KEG</b>	Vancouver, Washington (Pacific Air Transport)	45.0		<b>NKL</b>	Arlington	29.0, 37.4, 74.7	
<b>KEL</b>	Bolinas, Calif. (R.C.A.)	14.1, 29.3, 95.0		<b>NOSN</b>	U. S. Submarine Base, Coco Solo, Panama	40.0	
<b>KEMM</b>	Bolinas, Calif. (R.C.A.)	14.29, 28.58		<b>NPC</b>	Puget Sound, Washington	37.0	
<b>KESS</b>	Bolinas, Calif. (R.C.A.)	14.40, 28.80		<b>NPG</b>	San Francisco, Calif.	16.49, 32.98	
<b>KET</b>	Bolinas, Calif. (R.C.A.)	99.0		<b>NPL</b>	U. S. Training Ship, San Diego, Calif.	71.7	
<b>KEU</b>	Los Angeles, Calif. (Pacific Air Transport)	45.02		<b>NPM</b>	Honolulu, Hawaii	35.0 and 36.8	
<b>KEUN</b>	Bolinas, Calif. (R.C.A.)	14.08, 38.38		<b>NPO</b>	Cavite, Philippine Islands	68.0, 70.0	
<b>KEWE</b>	Bolinas, Calif. (R.C.A.)	14.08, 28.15		<b>NPU</b>	Tutuila, Samoa	37.0-40.0, 53.0	
<b>KFD</b>	Denver, Colo. (G. E. Co.)	17.7, 24.3		<b>NQC</b>	San Diego, Calif.	75.0, 86.0	
<b>KFHW</b>	SY. Poinsettia	40.0		<b>NQW</b>	U. S. SS. Mexico	40.0	
<b>KFOU</b>	Holy City, Calif.	31.0, 53.0, 63.0		<b>NRRG</b>	Winter Park, Florida	39.5, 82.0	
<b>KFVM</b>	SS. Idalia	17.0, 37.0, 74.0		<b>NRRL</b>	U. S. SS. Seattle	40.0	
<b>KFWB</b>	Los Angeles, Calif.	40.0		<b>NUQB</b>	U. S. SS. Pope	75.0	
<b>KFY</b>	Poinciana, Florida	68.4		<b>OCBA</b>	Bamako (Soudan)	41.50	
<b>KFZG</b>	Port Barrow	45.32, 69.25		<b>OCBV</b>	French Military Station at Beyreuth	58.0	
<b>KFZH</b>	Fairbanks, Alaska	44.71, 68.32		<b>OCCO</b>	Conakry (French W. Africa)	33.0	
<b>KFZO</b>	SS. Robador	37.5		<b>OCDA</b>	Dakar (French W. Africa)	35.0	
<b>KGBB</b>	U. S. SS. Ungava (R. B. Metcalf)	22.0, 37.0		<b>OCDB</b>	Djibouti	72.0	
<b>KGDU</b>	SS. Four Winds	35.03		<b>OCDJ</b>	Issy-les-Moulins	33.0	
<b>KGE</b>	Medford, Oregon (Pacific Air Transport)	46.06				65.0	1008-1028 G.M.T., Corresponding with OCDB Time Signal 0756 and 0955
<b>KGFT</b>	Portable Station, Texas	50.0				32.0	
<b>KGH</b>	Hillsbro', Oregon (Fed. Telegraphic Co.)	36.52, 46.99					
<b>KGT</b>	Fresno, Calif. (Pacific Air Transport)	46.06					
<b>KIO</b>	Kahuku, Hawaii (R.C.A.)	90.04					
<b>KKC</b>	Palo Alto, Calif. (Fed. Telegraphic Co.)	17.0, 27.5					
<b>KLL</b>	Bolinas, Calif. (R.C.A.)	21.85					
<b>KMM</b>	Bolinas, Calif. (R.C.A.)	14.29, 28.58					
<b>KMV</b>	Bandini, Calif. (Western Air Express, Inc., Morse)	49.5					
<b>KNN</b>	Honolulu (Mackay, R. & T. Co.)	17.2, 23.0, 23.7, 28.0, 34.4, 46.0, 47.4, 56.0					
<b>KNR</b>	Clearwater, Calif. (Fed. Telegraphic Co.)	29.5, 49.15					
<b>KNW</b>	Palo Alto, Calif. (Mackay, R. & T. Co.)	16.7, 17.0, 24.0, 33.4, 34.0, 48.0, 51.0					

	Stations and Location	Wave Length (Meters)	Remarks	Call Letters	Stations and Location	Wave Length (Meters)	Remarks
<b>OCMV</b>	French Military Station, Mont Valerien, Suresnes (Seine).....	39.0, 44.0, 46.0	At 1000, 1100 1230, 1330, 1600, 1900, 2000, 2100 and 2200 G.M.T. on either 600 cycles or D.C.	<b>PT</b> <b>PVC</b>	Quartel-General, Brazil..... Curacao.....	30.5 15.0-20.0	
<b>OCNG</b>	Nogent-le-Rotrou.....	29.0, 32.0, 45.0, 48.0, 72.0		<b>RABL</b> <b>RAU</b> <b>RA 19</b> <b>RCRL</b> <b>RCT</b> <b>RDI</b> <b>RDRL</b> <b>RDW</b> <b>RFM</b> <b>RFN</b>	Habarousk..... Tashkent..... Tomsk..... Central Lab., Leningrad..... Sebastopol..... Petrozavodsk..... Leningrad..... Moscow..... Khabarousk..... Moscow.....	22.0 23.0, 34.0 37.0 27.0 64.0 34.2 28.5 83.0 70.2 29.0	800-1000 G. M.T.
<b>OCRB</b>	Rinck, Meteo Aviation, Rabat, Morocco.....	36.0		<b>RKV</b> <b>RLT</b> <b>RRP</b> <b>RTRL</b>	Moscow..... Tommot..... Nijni Novgorod..... Tiflis.....	21.0, 34.0 23.0 20.0-42.0 22.0-42.0	
<b>OCRF</b>	Reggu, Morocco.....	74.0	2130-2145 G.M.T.	<b>SAA</b> <b>SAB</b> <b>SAD</b> <b>SAJ</b> <b>SDK</b> <b>SFR</b> <b>SGT</b> <b>SIC</b> <b>SKB</b> <b>SMHA</b> <b>SOJ</b> <b>SOK</b> <b>SPM</b>	Karlskrona..... Goteborg..... Flottads Stations, Stockholm..... Karlesborg, Sweden..... SS. Kiruna..... Paris..... Motorship Suecia..... SS. Masilia..... Motorship Gripsholm..... Stockholm..... Brazilian SS. Jaquarao..... Moskwa Sokoleniki Radio..... Radio Laboratory, Ministry of Posts, Helsingfors.....	44.0 36.5 31.0-51.0 50.0 54.0 75.0, 85.0 42.0, 50.0 42.0, 51.5 37.5 41.0 100.0 37.0 47.0	
<b>OCRU</b>	Rufisque (French W. Africa).....	39.0	Series of "a" from 1530-1540 G.M.T.	<b>SPR</b>	Sepetiva, Rio de Janeiro, Brazil.....	22.180	Meteorological reports, 1530 local time
<b>OCTN</b>	Mourillon, Toulon.....	20.0	Series of "b" from 1545-1555 G.M.T.	<b>SPU</b> <b>SPW</b> <b>SPX</b> <b>SP 1</b> <b>SUC 2</b>	Santa Cruz (Beam)..... Rio de Janeiro..... Rio de Janeiro..... Rio de Janeiro..... Abuzabal (Cairo).....	15.576 29.3 40.5 17.0, 44.5, 47.0 47.0	
<b>OCTP</b>	The Military Station of Nogent-le-Rotrou.....		Series of "c" from 1600-1610 G.M.T. daily, except Sun.	<b>TFA</b> <b>TSB</b> <b>TUK</b> <b>TVE</b>	Reykjavik, Iceland..... Norwegian SS. Helder..... Tomsk, Siberia..... SS. Solderijk.....	42.5, 49.5 46.5, 51.0 20.0 31.1	
<b>OCTU</b>	Tunis la Casbah.....	48.0, 50.0		<b>VAS</b> <b>VGJL</b> <b>VIS</b>	Louisburg, Nova Scotia..... SS. Canadian Commander..... Sydney.....	52.0 43.0 22.0, 26.0, 32.0, 42.0, 51.5 22.0, 42.0	Press report
<b>OHK</b>	Vienna.....	39.5, 40.6		<b>VIT</b> <b>VIZ</b>	Townsville, Queensland..... Ballan, Melbourne (Beam Station).....	25.728	
<b>OLO</b>	SS. Slammat.....	19.0, 22.5, 37.0		<b>VJZ</b> <b>VKO</b> <b>VNB</b>	Rabaul, New Britain..... Garden Island, Sydney..... Klipheupal, South Africa (Beam).....	22.0, 26.0, 32.0, 42.0 35.0 16.077, 33.708	
<b>OP</b>	Paris, Radio LL..... Paris, Radio Vitus..... Alfragidi, Lisbon (Beam).....	61.0 37.0 15.641	Phone Wed., Fri., Sun., 2100 - 2245 G.M.T.	<b>VQF</b> <b>VWZ</b> <b>VZDK</b>	Kuching, Sarawak..... Kirkee, Bombay (Beam)..... SS. Jervis Bay.....	32-38 16.286, 34.483 33.0	
<b>OU 7MK</b>	Copenhagen, Denmark.....	32.90		<b>W1XAO</b>	Belfast, Maine.....	40.0, 56.0, 60.0, 70.0	
<b>OU 7RL</b>	Copenhagen.....	42.12, 84.25		<b>W 1XAB</b>	Portland, Maine (Congress Square Hotel Co.).....	63.79	250 watts
<b>PCA</b>	Amsterdam.....	33.33		<b>W 1XR</b> <b>W 2XAA</b>	Manila, Philippine Islands..... Houlton, Maine.....	30.0 22.99	Phone after 2300 G.M.T.
<b>PCG</b>	Malabar, Java.....	17.0		<b>W 2XAC</b> <b>W 2XAD</b>	G. E. Co., Schenectady, N. Y..... G. E. Co., Schenectady, N. Y.....	50.0 21.96	Phone, Mon. Wed., Fri., 2300; Sat., 1900 - 2200 G.M.T.
<b>PCH</b>	Scheveningen Port.....	20.0, 20.6, 20.69, 21.127, 28.800, 29.226, 29.283		<b>W 2XAF</b>	G. E. Co., Schenectady, N. Y. transmitting program from WGY.....	32.7	Phone Tues., Thurs., and Sat., 2300 G.M.T.
<b>PCJJ</b>	Hilversum, Holland (Philips Lamp Works).....	30.2	Phone Wed., 1400-1600 G.M.T. and occasionally on Mon. and Fri., and other wavelengths below 60 meters (40 kw.)	<b>W 2XAI</b> <b>W 2XAL</b>	Newark, N. J. (Westinghouse Electric Co.)..... New York, short-wave transmitter of WRNY (Experimenter Publ. Co.).....	43.0 30.91	Phone and Television
<b>PCLL</b>	Kootwijk, Holland.....	46.0, 32.0, 18.0	and other wavelengths below 60 meters				
<b>PCMM</b>	Ministry of Posts and Telegraphs, Kootwijk.....	25.0, 27.5, 36.0	and other wavelengths below 60 meters				
<b>PCPP</b>	Kootwijk, Holland.....	27.0	and other wavelengths below 60 meters				
<b>PCRR</b>	Kootwijk, Holland.....	20.0, 25.0, 37.0	and other wavelengths below 60 meters				
<b>PCTT</b>	Kootwijk, Holland.....	21.0, 29.5	and other wavelengths below 60 meters				
<b>PCUU</b>	Dutch Colonial Ministry, The Hague.....	34.0	and other wavelengths below 60 meters (10 kw.)				
<b>PKD</b>	Koebang.....	24.0					
<b>PKE</b>	Amboina.....	20.0					
<b>PKH</b>	Soerabaja, Java (D. E. Indies).....	23.0					
<b>PHP</b>	Medan.....	15.5					
<b>PKX</b>	Java.....	27.0, 32.0					
<b>POF</b>	Nauen.....	13.5, 18.0					
<b>POX</b>	Nauen.....	20.0					
<b>POY</b>	Nauen.....	25.0					
<b>POZ</b>	Nauen.....	47.0					
<b>POS</b>	Alfragidi, Lisbon (Beam).....	118.270					



Call Letters	Stations and Location	Wave Length (Meters)	Remarks	Call Letters	Stations and Location	Wave Length (Meters)	Remarks
<b>W2XAO</b>	Belfast, Maine.....	40.0, 56.0, 60.0, 70.0		<b>WEQB</b>	Rocky Point, N. Y. (R.C.A.)	16.71, 33.42	
<b>W 2XAP</b>	New York (Bull Insular Line)	18.3, 18.7, 36.6, 37.5		<b>WEQC</b>	Rocky Point, N. Y. (R.C.A.)	16.78, 33.37	
<b>W 2XAW</b>	G. E. Co., Schenectady, N. Y.	3.0-20.0, 15.0		<b>WEQX</b>	Rocky Point, N. Y. (R.C.A.)	14.85, 29.71	
<b>W 2XBA</b>	Newark, N. J. (Short-wave Station of WAAM).....	65.18	Phone Mon., Wed., Fri., 2355 - 0500 G.M.T. 1 kw.	<b>WEQY</b>	Rocky Point, N. Y. (R.C.A.)	14.91, 29.83	
<b>W 2XBB</b>	New York (R.C.A.)	1-5		<b>WFV</b>	Poinciana, Florida (Florida RT Co.).....	70.54	
<b>W 2XBC</b>	Rocky Point, N. J. (R.C.A.)	14.09 and 5.35-18.74		<b>WFX</b>	Rocky Point, N. Y. (R.C.A.)	15.70, 31.59	
<b>W 2XBI</b>	Rocky Point, N. Y. (R.C.A.)	1-15	10 kw.	<b>WGI</b>	Alpena, Mich. (Alpena Marine Radio Service).....	98.3	
<b>W 2XAO</b>	Richmond Hill, N. Y. (Short-wave of WABC).....	22.1	Phone after 2300 G.M.T.	<b>WGT</b>	S. Juan, Porto Rico (R.C.A.)	21.75, 65.3	
<b>W 2XG</b>	Rocky Point, N. J. (Western Electric Co.).....	16.02	Phone Mon. and Fri. after 1700 G.M.T.	<b>WGW</b>	Vieques, Porto Rico (Bureau of Insular Telegraphs)....	52.0	
<b>W 2XH</b>	Schenectady, N. Y.....	50.0		<b>WGY</b>	Schenectady, N. Y. (G. E. Co.).....	35.0	
<b>W 2XI</b>	Schenectady, N. Y.....	30.0, 35.0, 38.0		<b>WHD</b>	Sharon, Pa. (Westinghouse Co.).....	49.0	
<b>W 2XK</b>	South Schenectady, N. Y. (General Electric Co.)....	65.5		<b>WHK</b>	Cleveland, Ohio.....	66.04	1/2 kw.
<b>W 2XN</b>	Rocky Point (R.C.A.).....	5-80	150 watts	<b>WHR</b>	Rocky Point, N. Y. (R.C.A.)	15.93, 31.96	
<b>W 2XS</b>	Rocky Point (R.C.A.).....	14.93	80 kw.	<b>WHW</b>	Highland Park, Ill. (Wireless Telegraph & Communication Co.).....	45.02	
<b>W 2XT</b>	Rocky Point, N. Y. (R.C.A.)	16.17	80 kw.	<b>WIK</b>	New Brunswick, N. J.....	21.48, 21.5	
<b>W 3XK</b>	Washington, D. C.....	46.72	Radio Movies) 30 kw.	<b>WIR</b>	New Brunswick, N. J. (R.C.A.).....	74.0	20 kw.
<b>W 3XL</b>	Bound Brook, N. J.....	60.0		<b>WIZ</b>	New Brunswick, N. J. (R.C.A.).....	43.35	Phone occasionally from 2300 G.M.T
<b>W 3XQ</b>	Mountain Lakes, N. J.....	37.95, 75.9		<b>WJD</b>	New York International News Service.....	37.01	
<b>W 4XK</b>	San Juan, Porto Rico (Bull Insular Line).....	18.3, 18.7, 36.6, 37.5		<b>WJZ</b>	Boundbrook, N. J. (R.C.A.)	18.17	
<b>W 5XH</b>	New Orleans (Tropical Radio Telegraphic Co.).....	42.0		<b>WKC</b>	Newark, N. J.....	17.5, 27.9	
<b>W 6XAI</b>	Inglewood, Calif.....	66.04	Phone 2400 G.M.T. on-wards	<b>WKI</b>	Newark, N. J. (Fed. Telegr. Co.).....	17.3, 27.9	
<b>W 6XAR</b>	San Francisco, Calif.....	33.00	Phone 2400 G.M.T. on-wards	<b>WKK</b>	Cuba, Porto Rico (Bureau of Insular Telegraphs).....	52.0	
<b>W 6XI</b>	Bolinas, Calif.....	29.3		<b>WLL</b>	Rocky Point, N. Y. (R.C.A.)	16.57	
<b>W 8XAO</b>	Detroit, Mich.....	32.0		<b>WLW</b>	Cincinnati, Ohio (Crosley Radio Corporation).....	52.02	2200 - 0400 G.M.T. except Fri. Special Time Signals
<b>W 8AXV</b>	East Pittsburg, Pa.....	62.50	(Radio Movies)	<b>WNBT</b>	Elgin, Ill.....	33.5	
<b>W 6XO</b>	Kahuhu, Hawaii.....	90.0		<b>WND</b>	Ocean Township, N. J. (American Telephone & Telegraph Co.).....	13.88, 16.35, 22.38, 32.69, 46.48	
<b>W 8XJ</b>	Columbus, Ohio.....	54.02		<b>WNU</b>	New Orleans, La.....	26.0, 40.0	Press reports
<b>W 8XK</b>	East Pittsburg (Westinghouse Co.).....	26.8	Mon. and Fri. 1900-2100 G.M.T.	<b>WOBD</b>	SS. Radio.....	37.0, 43.74, 77.0	
<b>W 8XS</b>	East Pittsburg, Pa.....	67.0, 96.0		<b>WOBV</b>	U. S. SS. Nippekontu.....	36.2, 72.4	
<b>W 9XU</b>	Council Bluffs, Iowa.....	61.06	Phone	<b>WOP</b>	Rocky Point, N. Y. (R.C.A.)	21.57, 43.14	
<b>WABC</b>	Richmond Hill, N. Y. (Atlantic Broadcasting Cpn.)	64.0		<b>WOWO</b>	Fort Wayne, Ind. (Main Auto Supply Co.).....	22.80	1 kw. Phone after 2300 G.M.T.
<b>WAJ</b>	Rocky Point, N. Y. (R.C.A.)	22.24, 44.48		<b>WPE</b>	Rocky Point, N. Y. (R.C.A.)	21.63, 43.14	
<b>WAQ</b>	Newark, N. J. (Westinghouse Elec. & Mfg. Co.)..	44.03		<b>WQA</b>	Rocky Point, N. Y. (R.C.A.)	14.13, 28.26	
<b>WBO</b>	Dearborn, Mich. (Ford Motor Co.).....	44.62		<b>WQB</b>	Rocky Point, N. Y. (R.C.A.)	16.71, 33.42	
<b>WBU</b>	Rocky Point, N. Y. (R.C.A.)	14.09		<b>WQC</b>	Rocky Point, N. Y. (R.C.A.)	16.78, 33.57	
<b>WBZ</b>	Springfield, Mass. (Westinghouse E. & M. Co.).....	50.0, 70.0	20 kw.	<b>WQN</b>	Rocky Point, N. Y. (R.C.A.)	51.5, 54.5, 57.0	
<b>WCFL</b>	Chicago, Ill. (Fed. of Labor)	37.24	1/2 kw.	<b>WQO</b>	Rocky Point, N. Y. (R.C.A.)	35.03, 44.0	
<b>WCGB</b>	Brooklyn, N. Y.....	54.0	1/2 kw.	<b>WQQ</b>	Rocky Point, N. Y. (R.C.A.)	14.8	
<b>WCSH</b>	Portland, Maine.....	63.79	1/2 kw.	<b>WQX</b>	Rocky Point, N. Y. (R.C.A.)	14.85, 29.71	
<b>WDJ</b>	Harrison, Ohio (Crosley Radio Corporation).....	21.4, 26.3		<b>WQY</b>	Rocky Point, N. Y. (R.C.A.)	14.91, 29.83	
<b>WDS</b>	Rocky Point, N. Y. (R.C.A.)	15.86, 31.73		<b>WRB</b>	Miami, Florida (Florida Radio Telegraph Co.).....	70.74	
<b>WEAJ</b>	Rocky Point, N. Y. (R.C.A.)	22.24, 44.48		<b>WRNY</b>	Coytesville, N. J. ("Radio News").....	30.91	Phone Mon., Wed., Fri., 1930 - 2215 G.M.T.; other days, 2355 - 0500
<b>WEAO</b>	Columbus, Ohio (Ohio State University).....	54.02		<b>WSS</b>	Rocky Point, N. Y. (R.C.A.)	16.0, 20.0	
<b>WEDS</b>	Rocky Point, N. Y. (R.C.A.)	15.86, 31.73		<b>WTT</b>	Rocky Point, N. Y. (R.C.A.)	16.02	
<b>WEEM</b>	Rocky Point, N. Y. (R.C.A.)	16.41, 32.84		<b>XC 51</b>	Mexico City.....	44.00	From 0400
<b>WETF</b>	Rocky Point, N. Y. (R.C.A.)	15.79, 31.39		<b>XDA</b>	Mexico City, Mex.....	34.0	Press reports 0500 G.M.T.
<b>WEGT</b>	S. Juan, Porto Rico (R.C.A.)	21.75, 65.3		<b>XEK 4AP</b>	German Aeroplane.....	42.5	
<b>WEHR</b>	Rocky Point, N. Y. (R.C.A.)	15.93, 31.96		<b>YN</b>	Lyons, France.....	58.0, 16.30, 17.30	
<b>WEM</b>	Rocky Point, N. Y. (R.C.A.)	16.41, 32.84		<b>YR</b>	Lyons.....	40.20	
<b>WEOP</b>	Rocky Point, N. Y. (R.C.A.)	21.57, 43.14		<b>YZ</b>	Fort d'Issy, France.....	45-47	
<b>WEP</b>	Cape Charles, Virginia (Norfolk Cape Charles Radio Telegraph Co.).....	99.9		<b>ZWT</b>	Bremerhaven.....	53.0	
<b>WEPE</b>	Rocky Point, N. Y. (R.C.A.)	21.63, 43.33		<b>ZZ</b>	Fort d'Issy (Portable).....	45-47	
<b>WEQA</b>	Rocky Point, N. Y. (R.C.A.)	14.13, 28.26					

# Custom Setbuilders!

## The Radio Set Market Tells Our Readers of Your Services FREE

### ARE YOU REPRESENTED?

In this magazine there appears, each month, a number of pages entitled the RADIO SET MARKET. In it we list, as a FREE Service the name and address of all custom setbuilders desiring to take advantage of this generous offer. The purpose of this section is to inform our readers of the whereabouts of these professional builders so that they may benefit by the superior quality of a custom-built set as compared to the manufactured radio receiver.

Turn to page 102 and glance over this section. If you are a custom setbuilder who works industriously and wholeheartedly to produce high quality radio receivers we will list your advertisement in the RADIO SET MARKET section of this magazine at no cost to you. Names are arranged geographically for the convenience of our readers. In this way, all that a reader, interested in procuring a custom-built radio set, need do is locate the name and address of the setbuilders in his locality and call on them for prices and specifications.

### CONDITIONS

Each advertisement will be keyed and listed geographically in the "RADIO SET MARKET" section as seen on page 102.

No advertisement more than fifty words. Each must be clearly written on a piece of white paper and attached to the coupon herewith. No request will be considered without the coupon.

No ad will be accepted from persons merely desiring to sell a set and who are not bonafide custom setbuilders.

We invite you to take advantage of this service. Fill in the coupon and mail it to us with your ad.

**RADIO LISTENERS' GUIDE and CALL BOOK**  
230 Fifth Avenue, New York City, N. Y.

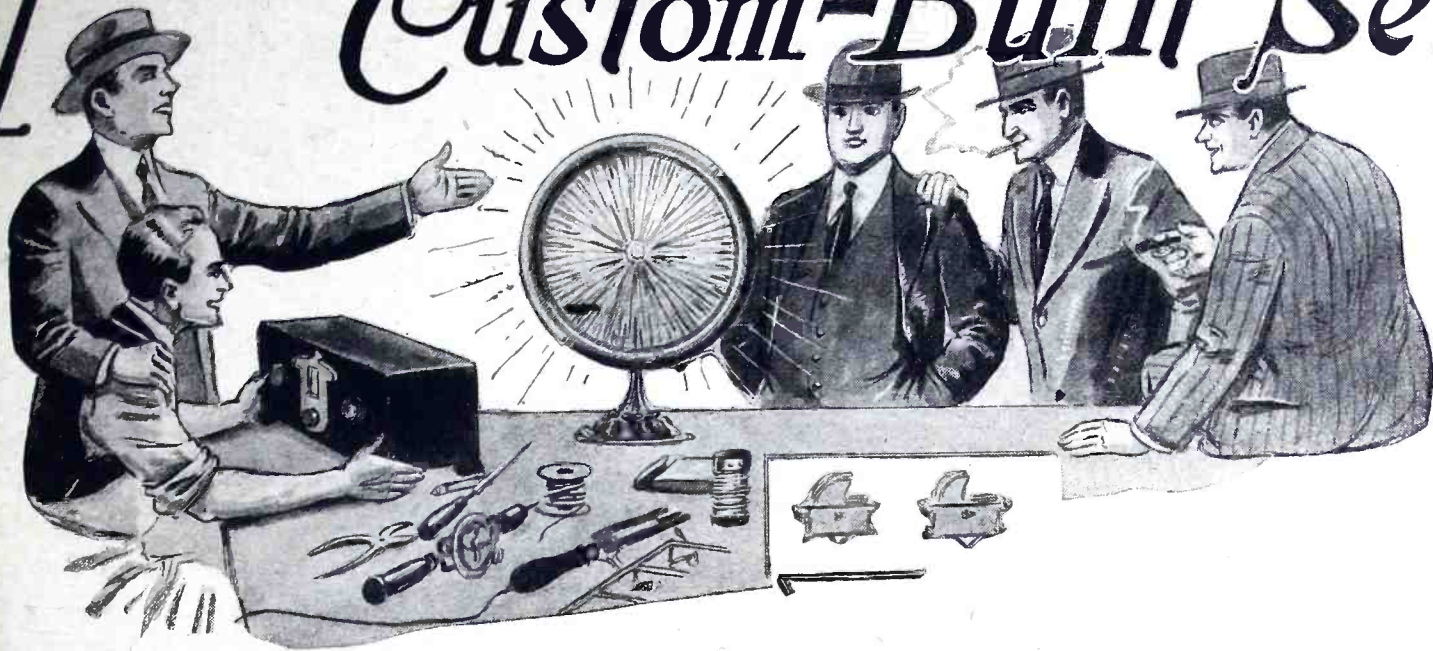
Radio Listeners' Guide and Call Book,  
230 Fifth Avenue, New York, N. Y.

1/29

Gentlemen:—Without cost or obligation to me, kindly insert the attached "custom made set offer" in your next issue.

Name .....  
Address .....  
City ..... State .....

# The Business of Selling Custom-Built Sets



ALL the way up and down Cortlandt Street, in New York City, radio dealers were asked: "How do the custom set builders sell the sets that they build?"

Cortlandt Street knows a lot about the business of radio. It has one of the greatest aggregations of radio shops to be found anywhere in the world. It is a radio street, from the big stores up near Broadway to the little holes in the wall down toward the docks.

Radio overflows into the side streets, where cabinet shops flourish and little establishments fill big display stands on the sidewalks with miscellaneous parts.

Commuters crowd every doorway and flock around every window and counter. They lug home everything from an electric console to a nickel's worth of bus bar. The dynamic loud speakers in front of the shops sound like a flock of brass bands, orchestras and opera companies engaged in a jamming contest.

Half the stores on Cortlandt Street carry large stocks of parts for radio sets. Some of them give half their space, or more, to parts. Hundreds of thousands of dollars worth of parts can be seen by walking two or three blocks up one side of the street and down the other.

Cortlandt Street knows its radio, and its answer to the question "Where do the custom set builders sell the sets that they make?" is: "They sell them to their friends." That statement shows that custom set building is on the surest, safest, most profitable foundation that any business could be built on. It may not be a business that a man can develop into a great enterprise of national scope, but it is an ideal business for the man whose genius lies more in the handling of tools than in executive work or the gift of gab that characterizes a certain type of salesman.

Cortlandt Street's statement is a true one, as anyone knows who has met many custom set builders. Take, for example, Johnson, who has worked up a large list of customers in a Pennsylvania city. Johnson is a mixer. He belongs to several lodges and he attends their gatherings and does his bit to enliven every

occasion. A man who shows himself friendly always has friends, and Johnson's friends give him all the advertising he needs. The more friends he has the more sets he sells, and the more sets he sells the more friends he has.

Sanford, a New Englander, has a different personality and his sales methods are adapted to his personality. He is not so much of a glad-hander as Johnson. He is primarily a mechanic. He loves to handle tools. He works so easily and efficiently that it is a pleasure to watch him.

Whenever Sanford is introduced to anyone, the fact that he is a radio man is likely to be mentioned. That gives them a topic of conversation, and the

way Sanford can talk radio makes it as romantic as a movie. The conversation usually winds up with the new acquaintance wanting to see Sanford's work shop. Here Sanford shows him the latest things in radio and answers the questions that a layman naturally asks. Before the visit is ended, the visitor finds that he wants a new and up-to-date receiver, although Sanford never asks anyone to buy anything. Which reminds us that everyone is interested in skilled mechanics, and inventors, but that no one ever erected a monument to a salesman.

Another thing that Cortlandt Street said about the custom set builder was that in almost every case he took an order for a set before he built it.



He goes home with the set. He changes the wiring in a half hour so that the set will meet the requirements of the customer who wants the latest type of radio receiver.

How a radio manufacturer would like to have that advantage, instead of being compelled to finance the production of thousands of sets before he knows whether anyone will buy them or not!

On Cortlandt Street customers can buy well-known and well-built radio receivers, in the original factory cartons, for \$15, \$25, \$39.50, almost any old price. A little while ago these same sets were selling for \$150 to \$500 or more. The manufacturers had to build enormous numbers of sets in order to be ready for the anticipated demand. Some other set caught the public fancy and the demand for these sets did not come up to the manufacturers' estimates.

Either the manufacturers made their customers pay enough profit on the sets that they did sell to cover also the surplus that they did not sell, or else they lost money. If they charged the high profit, their sets were priced above what a custom set builder could sell a good set for. If they lost money, they did something that the custom set builder does not have to do, because the custom set builder does not have to carry a stock large enough to lose much money on.

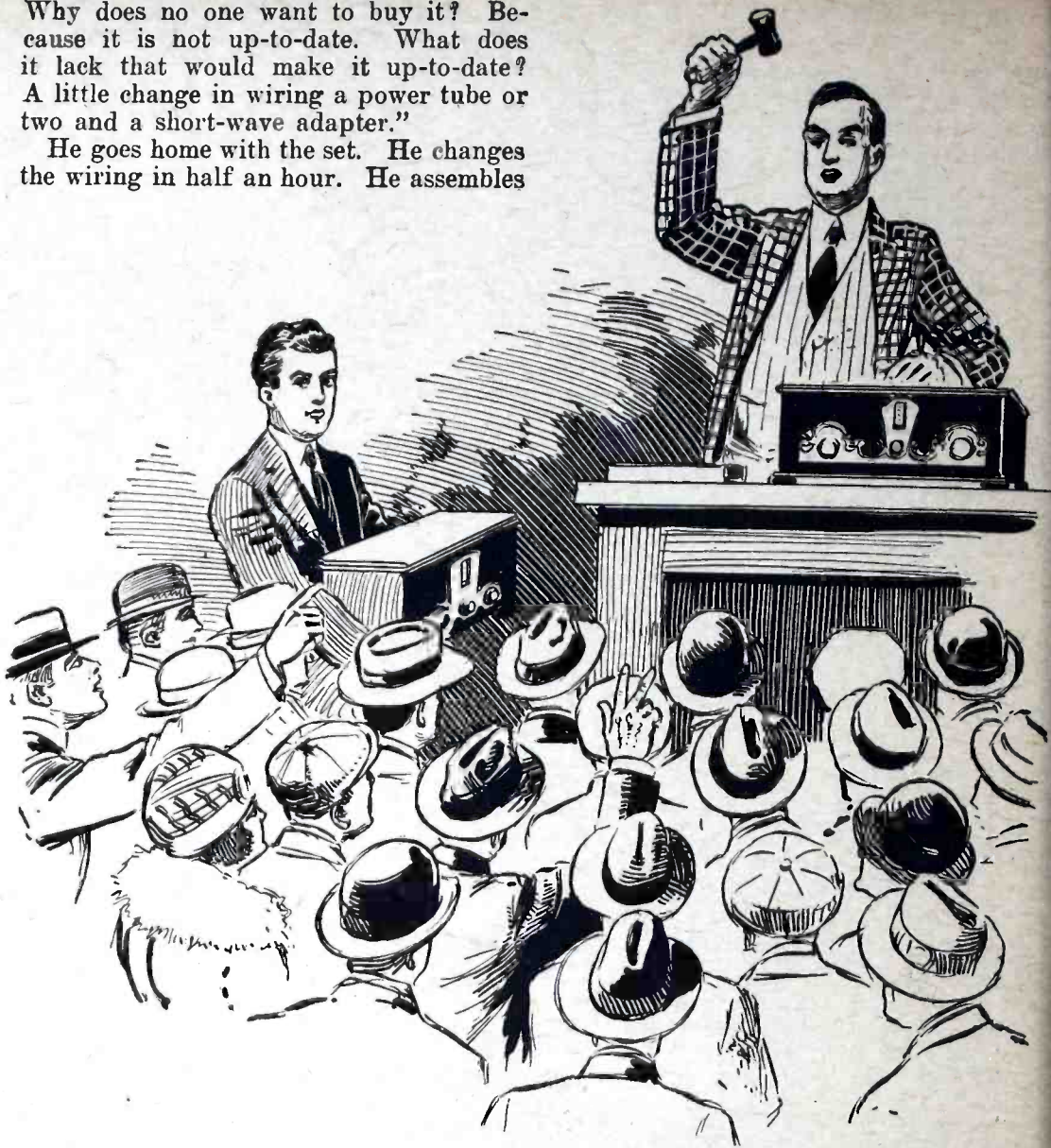
These bargain-sale sets, said one Cortlandt Street salesman, are knocking out the custom set builder. Is zat so! Look around almost anywhere and you can find a custom set builder who has solved that problem, as Holcombe did.

Holcombe, being in near-by New Jersey, visits Cortlandt Street to buy parts for sets that customers order. He runs across a set that was manufactured to sell at \$150 a few months ago but that is marked down to \$30.50. Some set builders are dumb enough to conclude that there is no use trying to meet the competition of such good and low-priced sets. They go home and shut up shop. Holcombe is sensible enough to figure it out this way:

"Why is a \$150 set marked down to

\$30.50. Because no one wants to buy it. Why does no one want to buy it? Because it is not up-to-date. What does it lack that would make it up-to-date? A little change in wiring a power tube or two and a short-wave adapter."

He goes home with the set. He changes the wiring in half an hour. He assembles



The people who attend auctions develop a desire for things that they never dreamed of wanting before. Sometimes they bid sets up to prices that they would not pay at a regular store.

a short-wave adapter and installs it so that his customer can get down out of the interference by slipping out a tube and inserting a plug. If his customer

wants the last word in radio Holcombe sells him a television outfit.

For the price of an ordinary factory job, Holcombe installs in the home of his customer a set with all the latest attachments, a set that nobody can buy in the radio shops. He makes \$25 or \$50. His customer is in a position to kid the neighbors for being behind the times. They call on Holcombe to build them sets like that.

Holcombe finds that in radio, as in all lines of business, being at the head of the procession is better advertising than talking your head off to sell what everyone else is selling. He keeps months ahead of the factories by putting out the new things, although he uses many sets and parts which, by themselves are somewhat out of date.

Rooney, a Middle-West set builder, says that any custom set builder who will guarantee his sets can sell them. And why not guarantee them? he asks. When you sell to your friends you naturally have to stand back of your goods. If not, you do not have any friends long.

And what an advantage he has over the manufacturer in giving a guarantee and making it good. He found, for example, that a set manufacturer located in Ohio sold to a jobber in Indiana. The jobber sold to a dealer in Indianapolis and the dealer sold to a customer in Rooney's town.

Something went wrong with the set.



A man at work in a window will stop more passers-by than any known device.

The customer complained to the dealer. The dealer sent a service man to look at the set. One day gone. The service man reported that the set was defective and that it was up to the manufacturer. The dealer wrote a letter to the jobber. Two days gone.

The jobber replied. Two or three more days gone. He said that he was taking it up with the factory. That meant a week or two. In the meantime, the dealer had to do one of two things. Either he had to take care of the customer by loaning him a set, which would cost money, or he had to let the customer grow madder every minute.

The factory assumed the responsibility for making good and the complaint was adjusted in about a month. But in another case the job of a favorite inspector in the factory depended on his proving that a set was not defective. It was his job to see that no defective set got by him. All arguments were hopeless. The dealer concluded that the manufacturer's guarantee meant nothing. For his own protection against crookedness the manufacturer had to word his guarantee so that his own interpretation governed in the handling of the complaint. He said that the set was not defective and that settled it. There was no redress.

Rooney tells of another dealer in his territory who asked for a new condenser bank to replace one that had gone bad in a power pack and who received this reply:

"Dear Sir:

"You should be spending your time selling radio instead of fussing with obsolete stuff."

The dealer went after the manufacturer, for the pack was less than a year old, and he was told that if he would send a check for the condenser bank the same would be forwarded to him. For the sake of the customer, the dealer sent the check. At the last report, three weeks had elapsed since the check went through the bank and the goods that were paid for had not been heard from!

Rooney says that he can take care of a similar complaint the same day that it is received and with a small fraction of the expense required when one goes the usual rounds. The way in which he takes care of complaints sells sets for him. He says he can always depend on manufacturers and dealers to do enough dumb things in his neighborhood to make his own meth-

ods stand out in a very favorable light by comparison. One manufacturer, he says, shipped a local dealer three new A.C. sets and every one of them blew up the first time the juice was turned on. The burning insulation threw off such a stench that it took hours to get the smell out of the house.

design. He says that he wants to try it out in a new location before delivering it. When the set goes in, it usually stays, for the customer finds it better than anything he has heard and asks Leslie to let him have it and build another for the other fellow.

Mahlon, who builds his own in a Connecticut town where a dozen New York concerns send their delivery trucks every day, secures customers by offering better exchange propositions than the dealers do. He finds that when a radio user wants a new set his first question usually is: "How much will you allow for the old set?"

The used set is a nuisance to the dealer. Often the allowance that he makes on it comes out of his profits. It is not good policy to put second-hand goods in the window with new goods. He cannot afford to sell a second-hand set to a customer who might buy a new set.

Mahlon has no such restrictions. He deals with each customer individually and the deal that he makes today sets no precedent for tomorrow. He remodels the old sets before selling them, to suit the customers' requirements.

Ivanko was an amateur, as most custom set builders are or have been. He bought parts at the radio counter of a department store. He did not like the way in which the radio

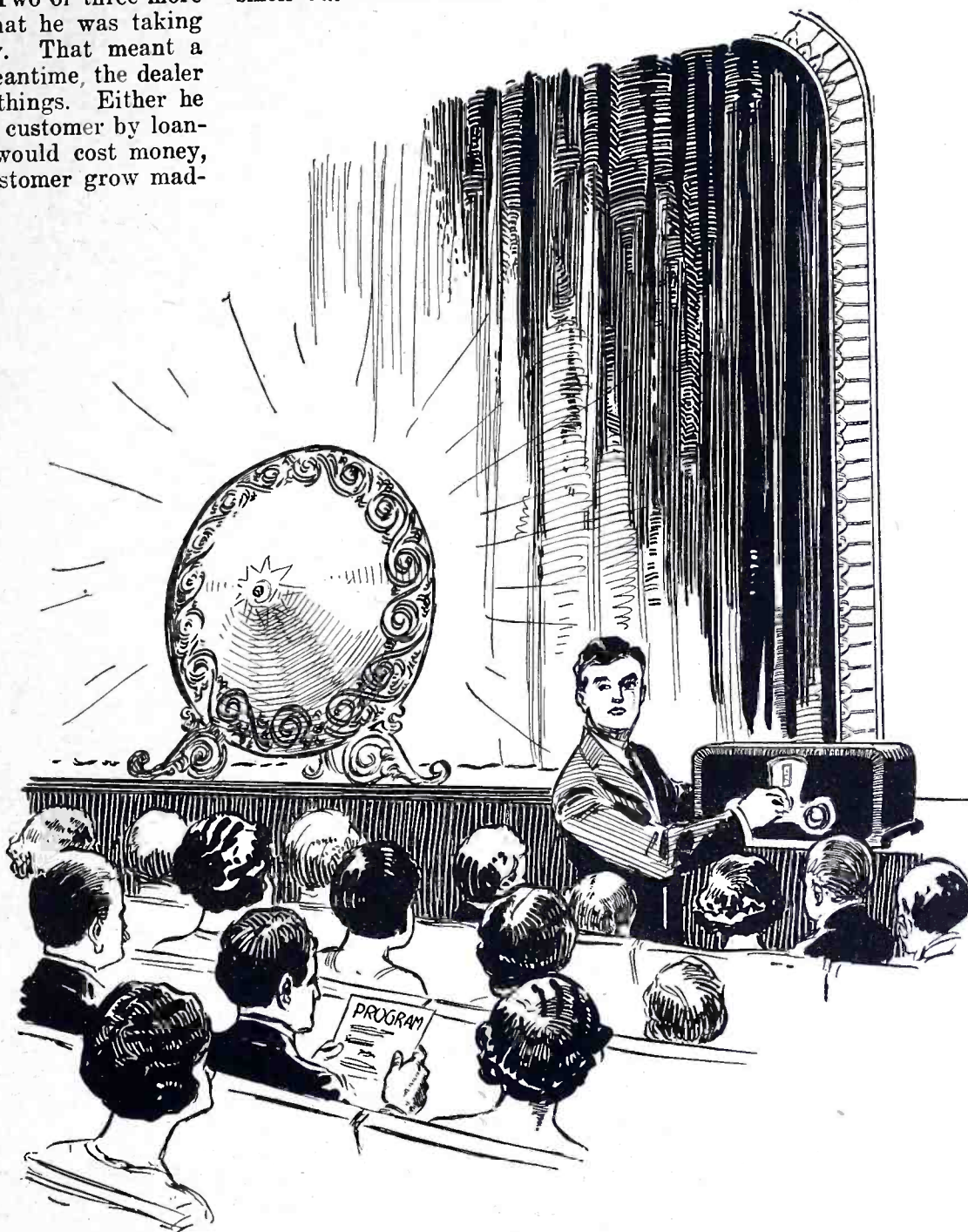
department was conducted, so he wrote a letter to the store manager, telling him what was the matter with the radio end of his business. The manager got even with him by making him manager of the radio department.

The store sold complete lines of parts and kits, but did not carry assembled sets. Some customers went away without buying because they wanted receivers that were assembled and ready for use.

Ivanko saw the opportunity. He asked the store manager for permission to assemble sets for customers who bought parts, stating that he would do the work on his own time, outside of business hours. The manager told him that anything that increased the sale of parts, kits and accessories was all right with him.

So Ivanko found himself in a position to become a custom set builder, with

(Continued on page 126)



Wilson's method of selling custom-built sets is to give demonstrations at public places.

The manufacturer and dealer have to depend on "help" that often hinders. Rooney gives every customer his personal attention.

Horton, who builds sets in Florida, says that some set builders feel that there is no more business for them because so many people already have radio. He says they are like the man who wanted to sell suspender buttons among the backwoods crackers, because he noticed that they seldom had more than one or two buttons and needed a lot more.

Horton, on the contrary, goes where the sets are thickest and gets all the business he can handle. He takes advantage of the fact that people grow tired of anything that they use day after day and want something new.

Leslie, whose field is in central New York, has a clever method for putting over his sets. He offers to loan a customer or a prospect a set of the latest

# The Qualifications OF A Radio Service Man



**I**F we judge by the number of men who enter the ranks of radio service men, radio receiver servicing must be a fairly lucrative enterprise. The same conclusion is inevitable when we consider that service goes hand in hand with sales and the number of receivers placed into operation each year is increasing with leaps and bounds.

Radio receiver servicing in its various branches is an art—a profession. The radio receiver of today is far removed from the foolproof status, and we honestly believe that a condition of foolproof operation will never be attained. Hence radio receiver servicing will be necessary as long as radio receivers are in use. The closest analogy is the automotive field. The present day automobile, irrespective of price classification, has been developed to a high state of perfection, yet automotive servicing is an established business. The increased number of cars in use counteracts the higher standards of manufacture.

Radio receiver servicing as we know it today has three branches all of which should be within the scope of the average service man. These three branches are, installation, repair and replacement. Under the circumstances, the successful service man must be a technician and a salesman. A small amount of technical knowledge, however, does not make one a service man. . . . Not that he is required to possess an engineering education—by all means no, but he must be familiar with technical problems associated with receiver performance. The salesmanship factor may be secondary, but it is present nevertheless.

Let us consider for a moment the qualifications of a service man employed to install receivers. To facilitate comprehension, we will segregate the three branches of servicing. . . . At first glance the installation of a radio receiver is a

simple procedure but a closer scrutiny will show a few complications. Let us assume a very prevalent condition. The purchaser has never had a receiver and the new installation requires an outdoor elevated aerial. The erection of an aerial is a simple matter but only after certain factors have been given due consideration. The first is receiving conditions in the neighborhood in question. The importance of this fact was brought to the attention of the writer during a radio survey of New York City, and the phenomena noted are applicable to every city. Reception differs in different parts of the city, and the variation in reception is appreciable. Some stations are received with exceptional intensity. Other stations are poorly received. Adjacent buildings cast shadows which manifest a decided influence upon reception at any one point. Every possible means must therefore be exhausted to so arrange the outdoor aerial that the stations are received with uniform intensity. This means that the aerial must be made non-directional to the stations received with exceptional intensity and directional to the stations poorly received in the neighborhood. The above is possible only when the installation man "knows his neighborhood," and the directional effects of various types of elevated aerials. Much controversy has been extant about such aerials and quotations have been made to the effect that the average outdoor aerial installed for broadcast reception is too small to display directional properties. Experience, however, proves the contrary.

Another consideration associated with the above is a knowledge of the radio frequency amplifying characteristics of the receiver in question. All receivers do not

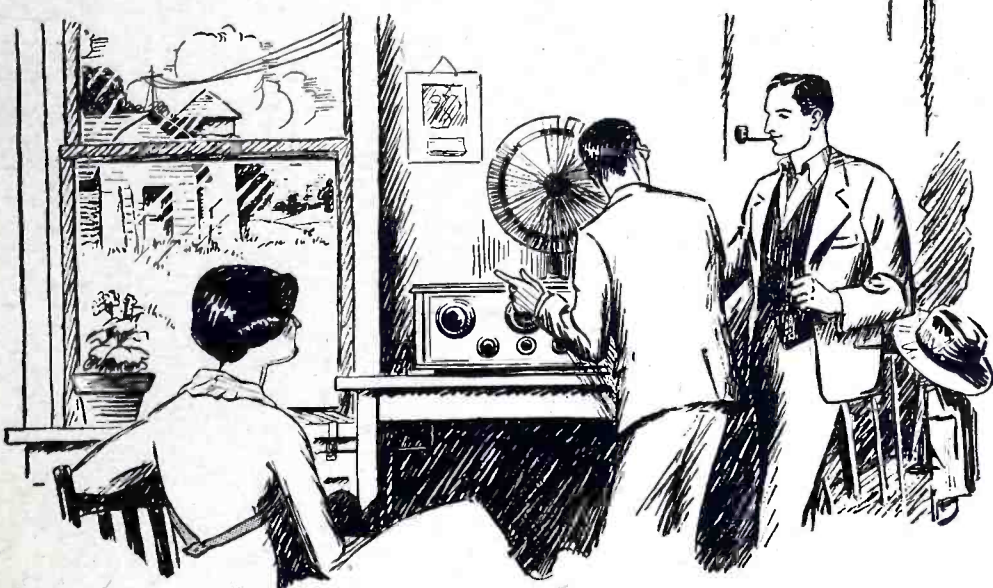
amplify carrier frequencies uniformly. A knowledge of this receiver characteristic plus the receiving conditions in any one neighborhood will greatly aid the erection of an aerial which will result in satisfactory uniform response.

Another instance of installation service, dependent upon the knowledge possessed by the installation man, is information pertaining to the available power supply. We assume an electric set utilizing a loop aerial. The erection of an outdoor aerial is therefore unnecessary. We assume that the installation man can differentiate between an A.C. and a D.C. receiver although we were present during the installation, or rather the attempted installation of a popular A.C. receiver in a home supplied with D.C. power. The result was the anticipated; the power transformer in the receiver went up in smoke. The important item, however, is the knowledge of the available line voltage, the requirements of the receiver and the adjustment of the power input control on the receiver, in order to adapt the unit to the available line voltage. Neglect of this consideration has been the cause for much complaint and the basis for the short life of many A.C. tubes.

Still another instance of installation service is the placement of the loud speaker, assuming a receiver with a separate and external loud speaker. Reflection of sound waves within a room is an important item and influences the apparent performance of the speaker. Incorrect placement of the speaker will increase reflection and cause reverberation. The speaker should not be in line with loose objects which would tend to vibrate in sympathy with the sound waves projected from the speaker. Correct placement of the speaker is conducive to bet-

ter performance and greater general satisfaction. It is evident that the installation man or the service man must know something about acoustics.

The repair service man must be an analyst, a diagnostician. He must understand cause and effect. He must diagnose symptoms when they are present and isolate defects and defective operation. To do this, he must understand phenomena accompanying operation. He must comprehend possible faults and their location. To accomplish this he must understand the operation of the various parts or systems of a complete receiver installation. It is true that many defects display similar reactions, but each defect displays a different reaction when a test unit is applied. This is an important consideration. The service man must know conditions present for defective or perfect operation. His knowledge must be sufficient to permit the interpretation of the test unit determinations.



Radio receiver servicing in its various branches is a profession as much as any other highly trained art. When the radio service man calls at a home to inspect, install, or repair a set he must be qualified to accomplish matters intelligently.

Commercial testing units suitable for continuity receiver testing have found wide sale among service men. These units



A radio test set used to check circuits, test tubes, "A" and "B" eliminators, batteries, voltages in circuits, etc., etc.

expedite servicing but only if the user can interpret the meter readings correctly. Such interpretations are possible only

when the repair man is familiar with the phenomena or actions resulting from a certain condition. Innumerable examples of the above are possible but space does not permit a lengthy discourse. We must therefore confine ourselves to the most important items. Distortion is a frequent complaint. The isolation of the point or source of trouble causing the distortion of signals is a complicated matter if the service man is unfamiliar with the correct operating conditions of each part of the receiver. The isolation of the source of trouble is a process of elimination—after one has determined that the voltages applied are correct.

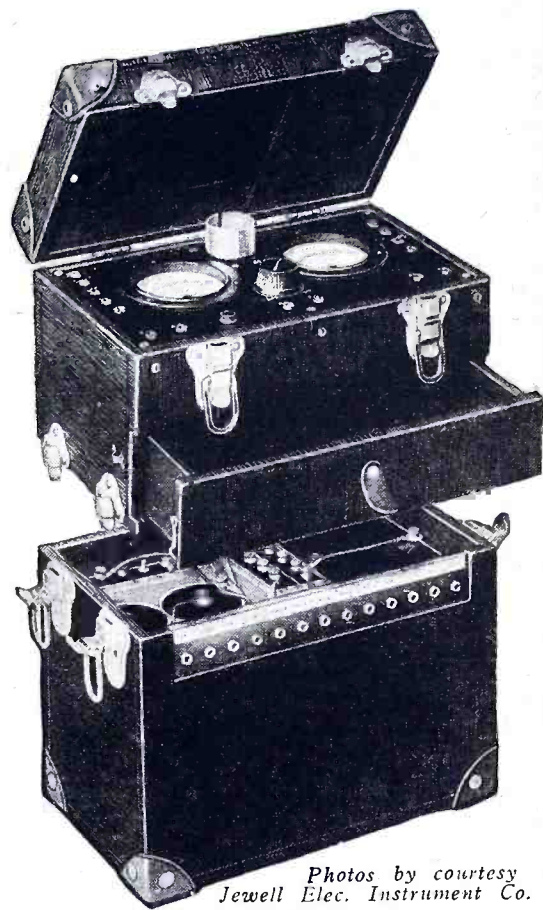
The service man must know how to determine the presence of distortion as indicated by an aural observation. He must be familiar with circuit conditions likely to cause this type of defective operation. He must be familiar with the "metering" of a circuit to indicate distortion. A thorough knowledge of the

correct operating conditions of a vacuum tube as a radio frequency amplifier, as a detector, as an audio amplifier, as a voltage amplifier or a power amplifier, is imperative. The significance of grid current in radio frequency and audio frequency amplifiers must be understood. The significance of uneven grid current variations in A.F. systems must likewise be familiar to the service man.

One of the greatest fallacies existing among radio service men is the interpretation of grid current meters. Very many believe that the insertion of a meter into the grid circuit of an R.F. or an A.F. tube circuit, indicates defective operation unless some deflection is noted on the meter. Grid current is the exact undesired condition. A milliammeter placed in the grid circuit of a radio frequency or an audio frequency amplifier should not indicate the presence of grid current. Grid current in such systems is detrimental and is indicative of incorrect receiver operation, showing insufficient filament, grid or plate voltages or excessive signal voltage.

The advent of the A.C. tube has complicated matters. It is now necessary for the service man to be familiar with the optimum operating conditions for the various types of tubes, particularly the 226, which has a definite plate current limitation and filament circuit balance

limitation. These are important since they govern the amount of voltage ripple or hum present in the system. The presence of hum in an installation is enigmatical and it can be cured only when



Photos by courtesy Jewell Elec. Instrument Co.

A service test set used by the well equipped radio service man.

the repair man is familiar with the possible causes of this phenomenon. The service man must be familiar with the operating characteristics of the filament type of A.C. tube and the heater type of A.C. tube. He must understand thoroughly the wiring system employed in the A.C. receiver in question, since various methods of obtaining a desired condition are possible.

A thorough knowledge of Ohm's law as applied to D.C. circuits is imperative since the law finds frequent application during the interpretation of test unit determinations. The service man must be familiar with the I R drop in various parts of the receiver. Such voltage drops influence meter readings and cause voltage variations between the source of voltage and various parts of the receiver. Only by interpreting correctly the voltage drop in systems, can one decide if the correct voltage is being applied to any system. Ohm's law as applied to D.C. circuits and a knowledge of A.C. voltages is very necessary when servicing or testing "B" battery eliminators. An understanding of the two-element vacuum tube as a rectifier is likewise necessary. The difference between "peak" and "defective" values of A.C. voltages is also imperative since it governs the selection of replacement parts in A.C. circuits. Ohm's law finds frequent application when determining the efficacy of a voltage distribution system.

The service man should be familiar with reactance and impedance phenomena associated with capacities and inductances, since they guide the choice of these units to perform a certain operation and effect the economical purchase of such units.

(Continued on page 133)

# BUILDING A CORNER CABINET FOR THE RADIO SET



Square up a piece of 2 in. by 4 in. stock to 1½ in. by 3½ in. by 2 ft. 3 in., for the front rail shown in Fig. 4. Notch the ends, on the lower edge, 1¾ in. deep and 1½ in. long, to fit into corresponding notches in the corner stiles.

The back rail has no notches, and is just 2 ft. long.

The two corner stiles are also sized to 1½ in. by 3½ in. Cut them 2 ft. 5¼ in.

long, rabbet the back corners on the inside faces ¼ in. by ¾ in., to receive the front edges of the side jambs, and notch the upper ends 1¾ in. by 1½ in. See Fig. 5.

## MATERIAL LIST

- 3 pc. 2 in. by 4 in. by 8 ft. pine or fir, S4S
- 1 pc. 1 in. by 12 in. by 14 ft. pine or fir, S4S sanded
- 1 pc. 1 in. by 12 in. by 12 ft. pine or fir, S4S sanded
- 1 pc. 1 in. by 10 in. by 6 ft. pine or fir, S4S sanded
- 1 pc. 1 in. by 3 in. by 12 ft. pine or fir, S4S sanded
- 1 pc. 1 in. by 2 in. by 12 ft. pine or fir, S4S sanded
- 1 pc. ½ in. by 6 in. by 3 ft. round-edge baseboard
- 1 pc. ⅝ in. by 3 in. by 3 ft. wainscot cap
- 1 pc. ⅜ in. 3-ply pine panel veneer 30 in. by 5 ft.
- Wallboard as required
- Casing as required
- 4 prs. 2 in. by 2 in. loose pin butts
- 4 1½ in. glass knobs
- 2 elbow catches
- 2 frog catches
- 1 doz. shelf hooks.

A lower rail is made from 1 in. by 3 in. stock sized to ¾ in. by 2½ in., and cut 2 ft. long.

The back of the cabinet, as Fig. 2 shows, extends across the side jambs, into the ends of which it nails, but the back laps over its back edge and nails into it. This consists of a rectangle of 1 in. stock 9½ in. by 2 ft. 1½ in., with the back corners mitered off 3 in., as in Fig. 7.

The lower book shelf is 8½ in. wide and 2 ft. ½ in. long, with the back corners mitered off 2½ in. The ends dado into the side jambs ¼ in., and the front edge rests in a rabbet in the molded nosing.

Fig. 9 illustrates the radio shelf, which is ¾ in. by 10¾ in. by 2 ft. ½ in. Like the lower book shelf, the ends rabbet ¼ in. into the side jambs; and for this purpose the ¼ in. by 3 in. notches are cut, permitting the front edge to fit between the corner stiles.

The bottom shelf is 10 in. wide, and notched back 2¼ in.

The countershelf, shown in Fig. 10, is 10½ in. by 2 ft. 4 in., with the back corners notched 1¼ in. by 6 in.

Fig. 11 shows the right lower jamb. Miter the back edge, ripping to a width of 7¾ in., after jointing the front edge straight. Square to a length of 1 ft. 11¾ in., and cut a ¾ in. dado ¼ in. deep, full width of the wider, or inner, face, 10½ in. from the upper end. A like dado is made 1 ft. 6¼ in. from the first. Glue and nail the front edge into the rabbet of the right corner stile, the tops of both members being even.

Make the left jamb to complete the pair.

Now assemble the sides and lower shelves, driving 6 d. common nails through



Boring for the dowels in a stile.

THE home mechanic who attempts to build for his radio set a cabinet that will contain the loud speaker, usually finds this unit decidedly a limiting factor. Cone speakers are easily built in, but the crook-necked horn variety, either because of extreme height, or great depth from front to back, are discouragingly hard to manage.

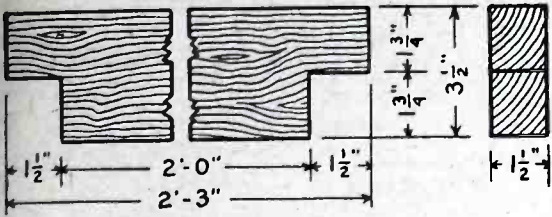
The corner cabinet design offered here, however, has space for almost any kind of a loud speaker. The batteries or eliminators are hidden in the lower cupboard, and the radio panel, when not in use, is concealed behind small doors under the countershelf; while the speaker, occupying the corner space, is screened by a well-designed grill sawed from panel veneer. Bookshelves are provided above which complete this novel cabinet.

The first task is to trim an opening for the cabinet. Lay out on the floor, at an angle of 45 degrees with the walls, a line 1 ft. 7⅞ in. from the actual corner. On the ceiling draw a corresponding line, determined by plumbing up from the floor with a level held against a straightedge. Nail to the ceiling, guiding on this line, a plate cut from a 2 in. by 4 in. stick sized on all sides. Nail two vertical pieces, the side trimmers, to the floor and the ceiling plate, centering on the line, and 2 ft. 3 in. apart, inside measurement. See Figures 2 and 3. Plumb these carefully. Nail a head trimmer between them 6 ft. 10½ in. above the floor, leveling it. Nail evenly spaced short studs, or "cripples," between it and the ceiling plate.

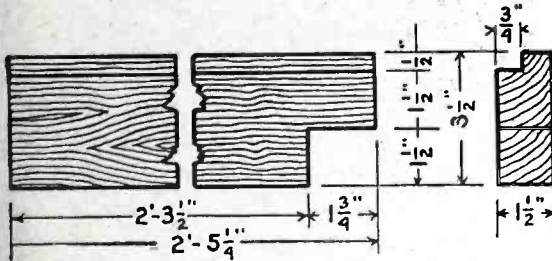
Fill the spaces between the walls and side trimmers with 2 in. by 4 in. studs turned flatwise, as indicated, trimming the corners as necessary, and spiking solidly. Cover the new wall with plaster well fitted to the old wall.



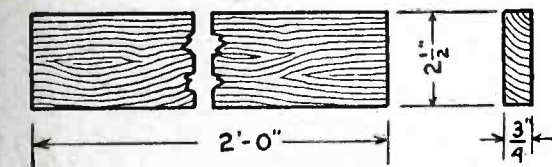
the jambs into the shelf ends. Force the upper rail into place, nailing the notched ends from the top and from the lower edge. Toenail the lower rail through the



**Fig 4** UPPER FRONT RAIL  
Make back rail 2 in. long. No notches

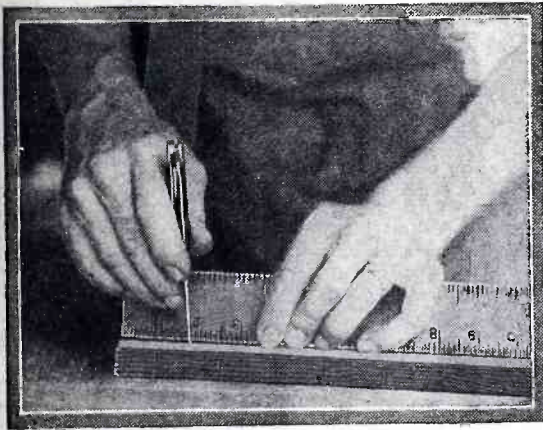


**Fig 5** STILE - Make one pair

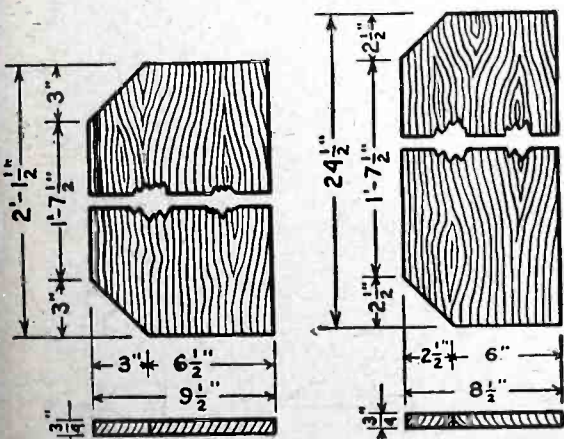


**Fig 6** LOWER RAIL

edges, showing a margin on the shelf front of 1/4 in. Square the assembly, bracing the front and back by tacking a



The way to measure accurately is to use the blade of a jackknife and a steel rule as shown above.



**Fig 7** CABINET TOP

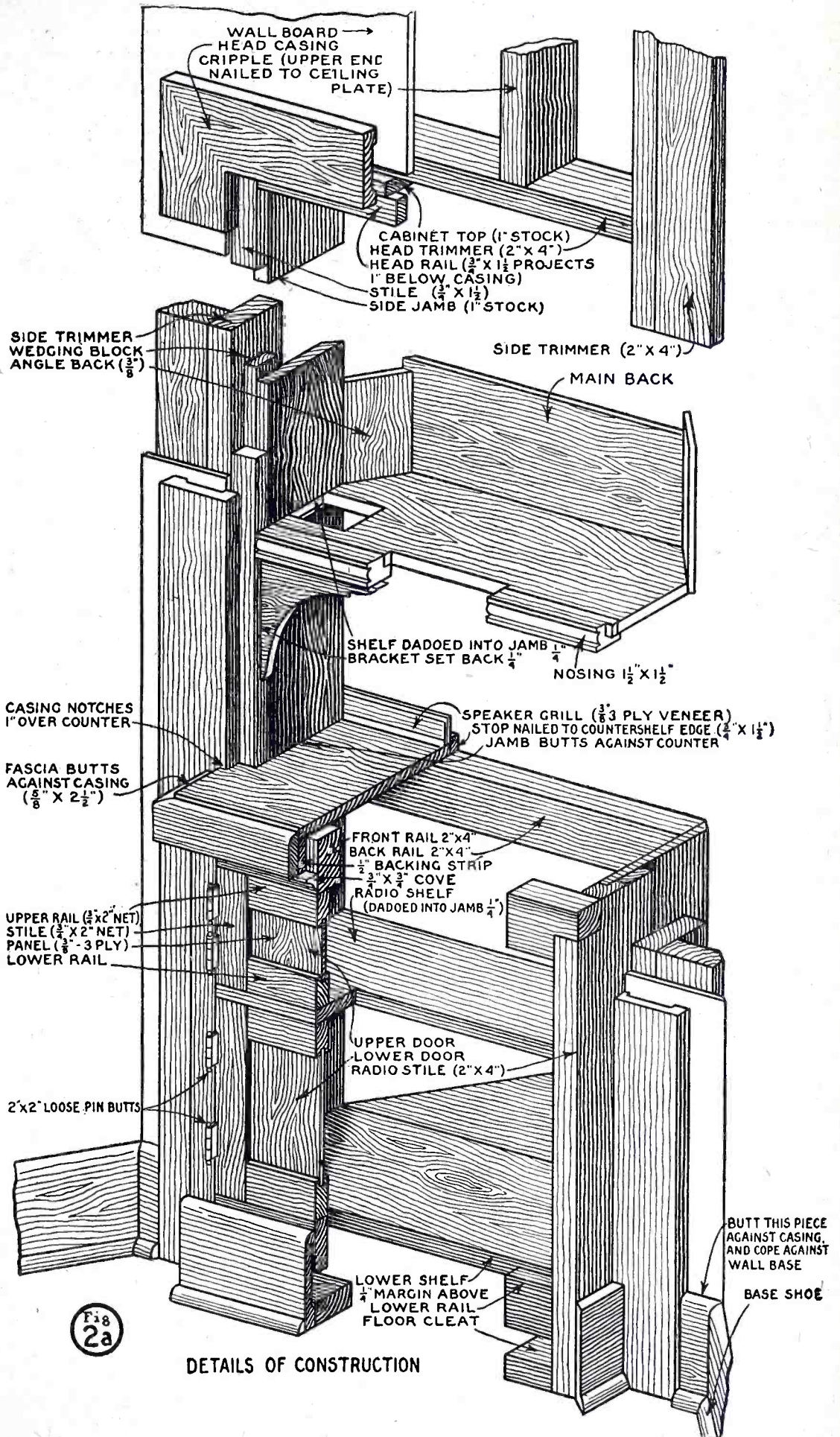
**Fig 8** LOWER BOOK SHELF

diagonal strip over each, and stand in the trimmed opening.

Plumbed and leveled, and nailed in place, the front should be 31 1/4 in. in front

of the wallboard. Strips 3/4 in. by 1 1/2 in. between the jambs and the side trimmers are needed for backing. Complete the bottom shelf by nailing in the triangular back shelf section, supporting it on cleats, or on the baseboard, if it is the right height.

Fig. 12 details the left upper jamb. Cut the stock 4 ft. 5 in. long, joint the front edge, and scribe the lower end to the countershelf, placed 4 1/4 in. from the front edge of the latter. Cut off 1/2 in. Then rip the width to 5 5/8 in., for a distance of 1 ft. 2 in. from the lower end.



**Fig 2a**

**DETAILS OF CONSTRUCTION**

Dimensions for rails, stiles, top of cabinet and lower book shelf are given in the left column of this page. Directly above are shown details of the cabinet.

Nail to the back edge of the countershelf a strip of 1 in. by 2 in. stock as backing for the lower edge of the speaker grill. Place the shelf with 1/2 in. projection at the ends and front, and nail solidly with 6 d. finish nails to the front rail and corner stiles and jambs.

Rip the rest mitering on the back edge, giving it a width of 6 1/2 in. Dado the narrow portion flush with the offset back, 3/4 in. wide and 1/4 in. deep. Bore 1/4 in. holes 2 in. apart on a line 1/2 in. from the front edge, and one 1 in. from the back edge, starting 6 in. above the dado and

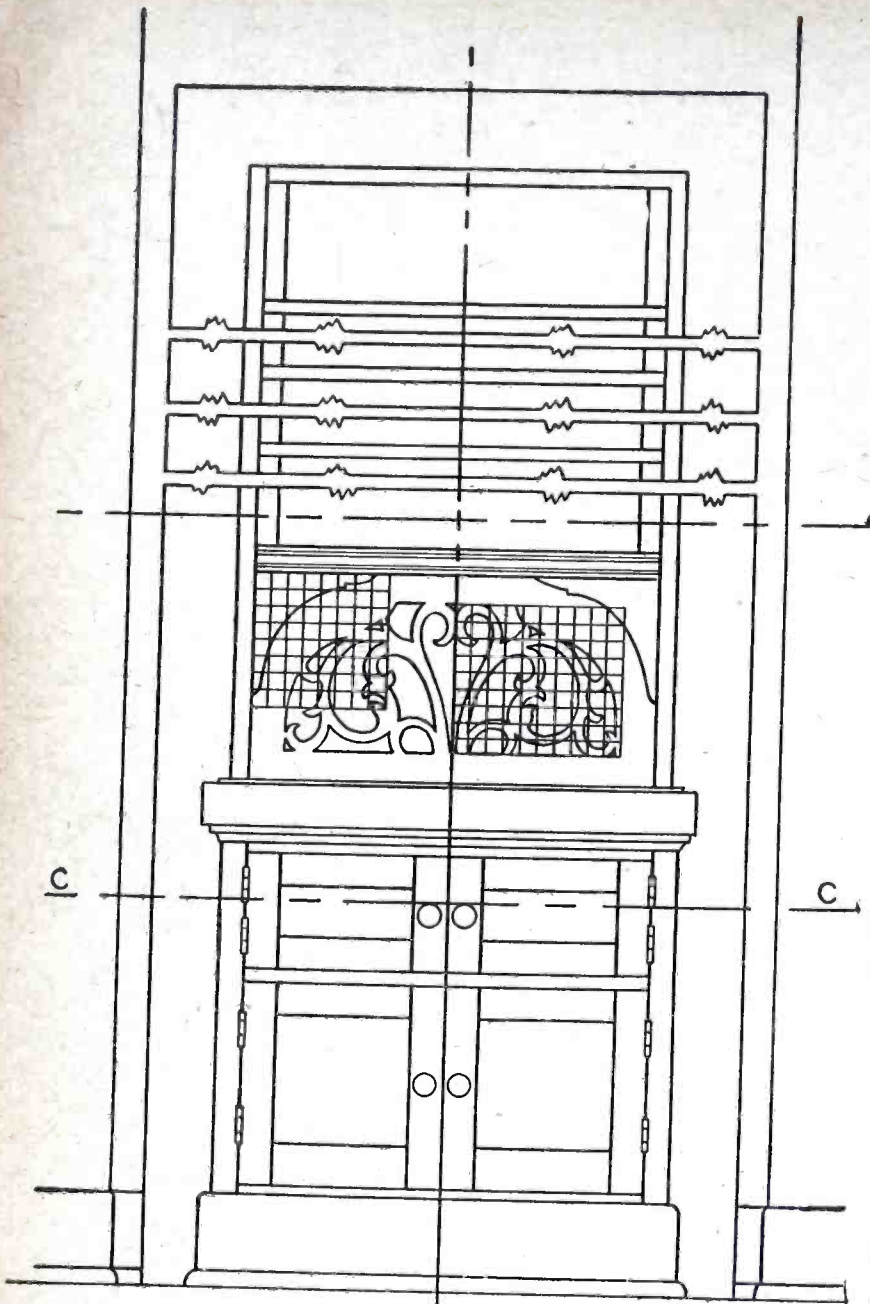


Fig 1

FRONT ELEVATION

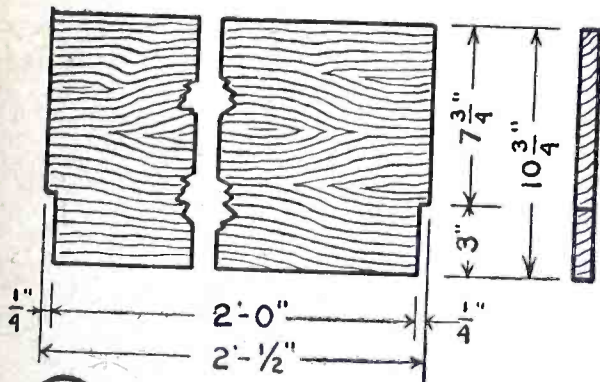


Fig 9

RADIO SHELF

The illustrations on this page and the opposite show constructional details of the corner cabinet.

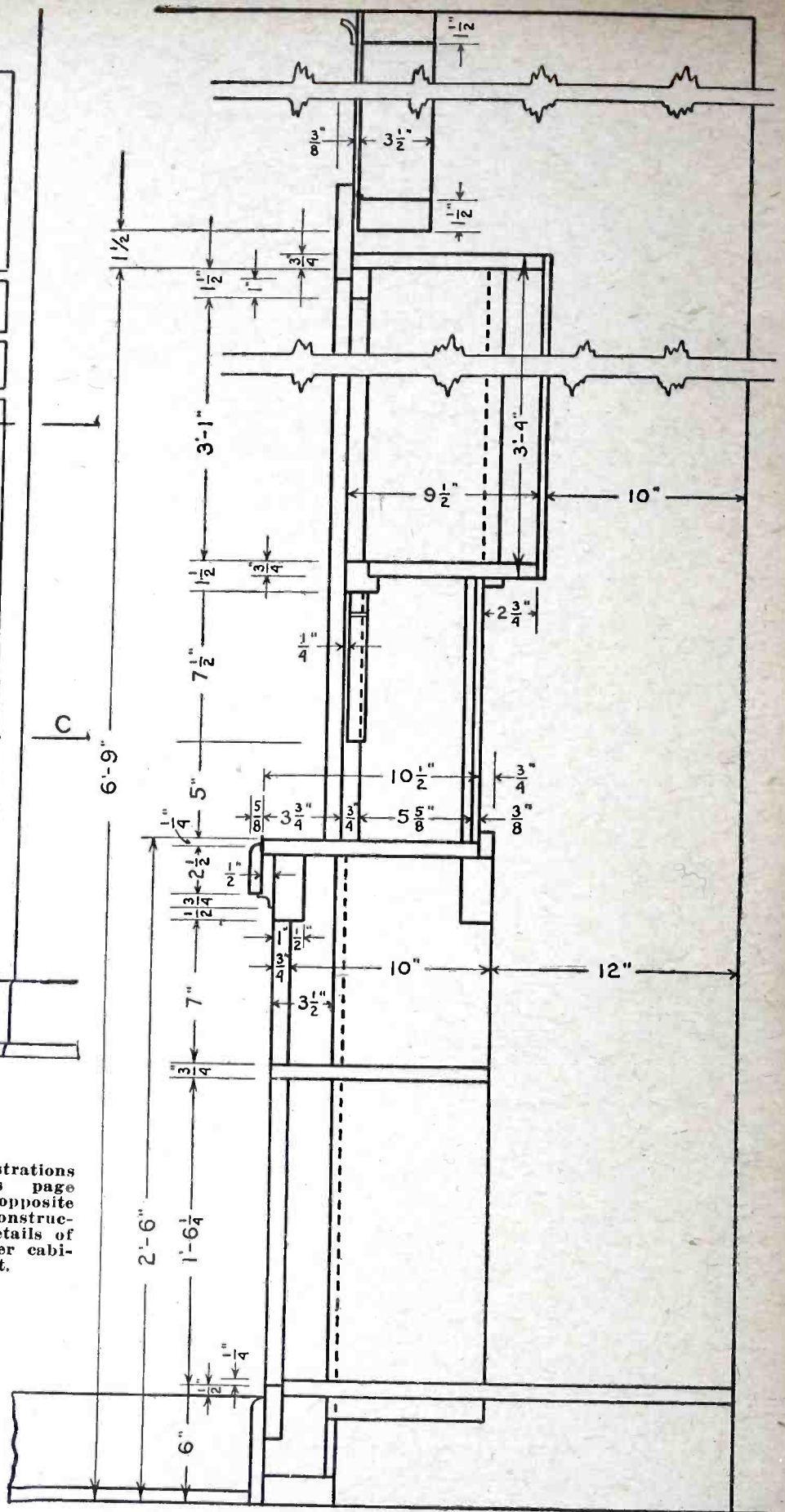


Fig 2b

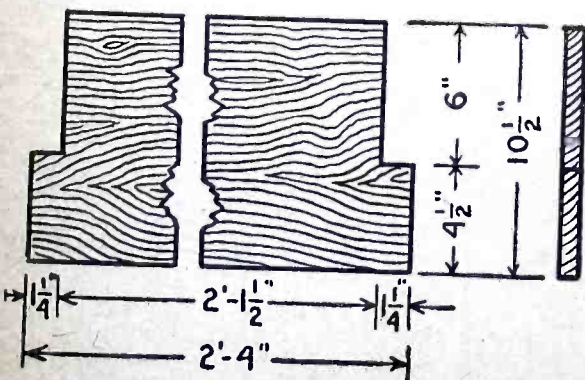


Fig 10

COUNTERSHELF

finishing about 4 in. below the top.

Make the right jamb as its mate, and assemble the two with the top and the lower book shelf. Square the frame, and nail on the back of 3-ply veneer, as indicated in Fig. 2.

Nail 1 in. by 2 in. backing strips to the studs and set the upper assembly. On the underside of the lower book shelf nail a stop for the upper edge of the grill.

(Continued on page 132)

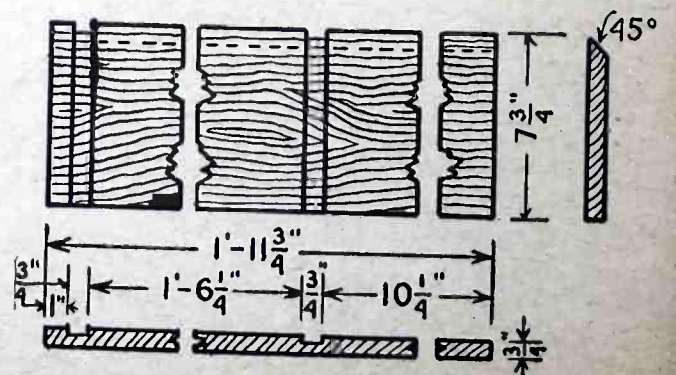


Fig 11

RIGHT LOWER JAMB  
Make 1 pair

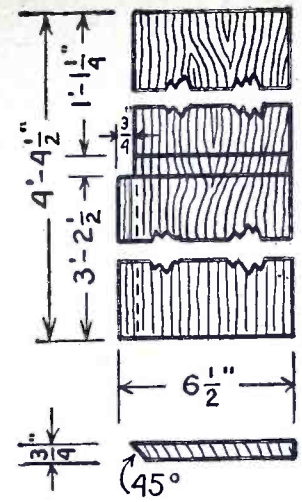
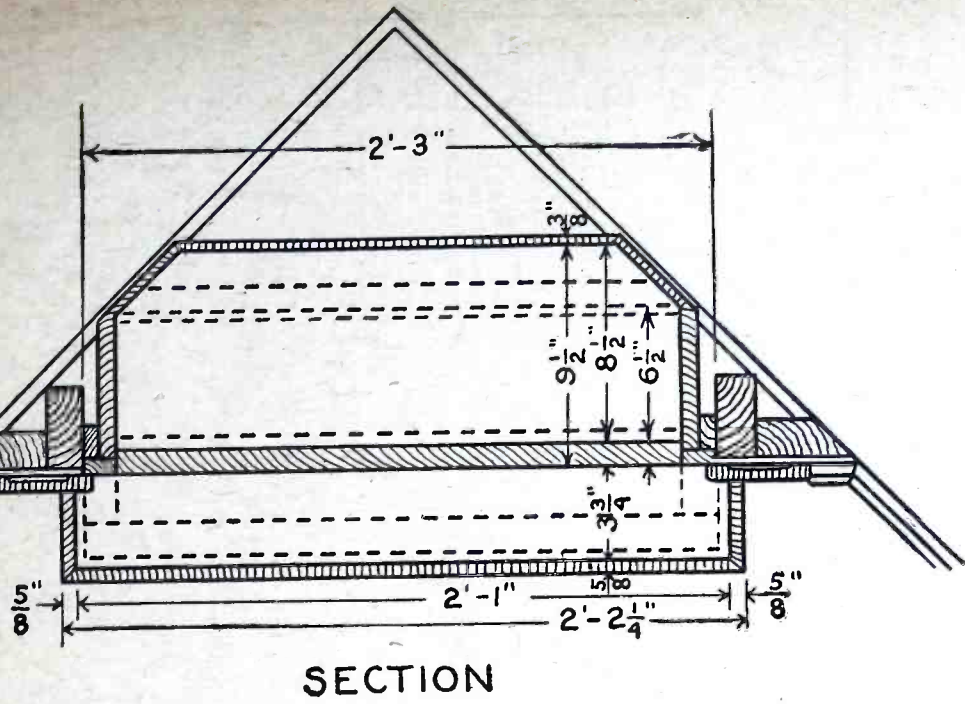


Fig 12 LEFT UPPER JAMB  
A pair required

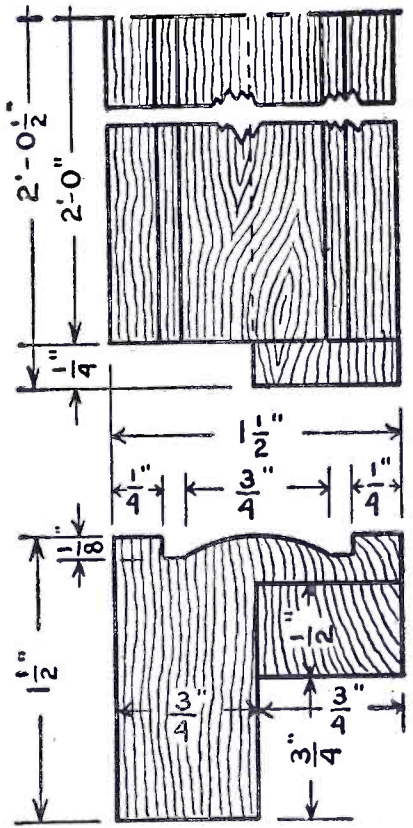
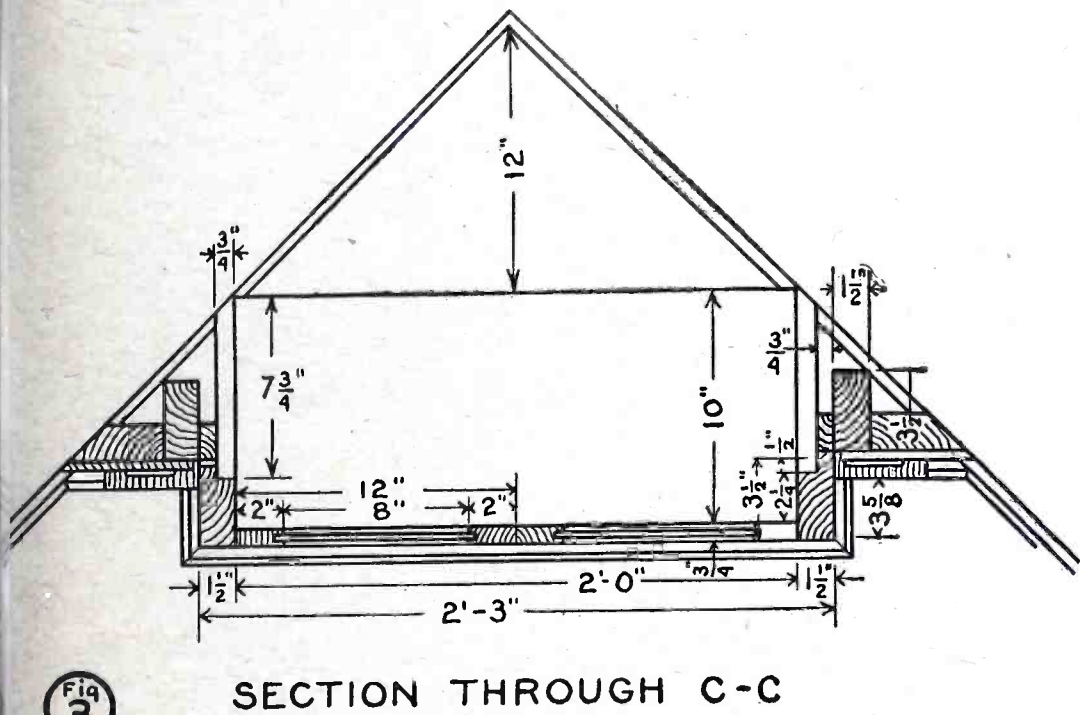
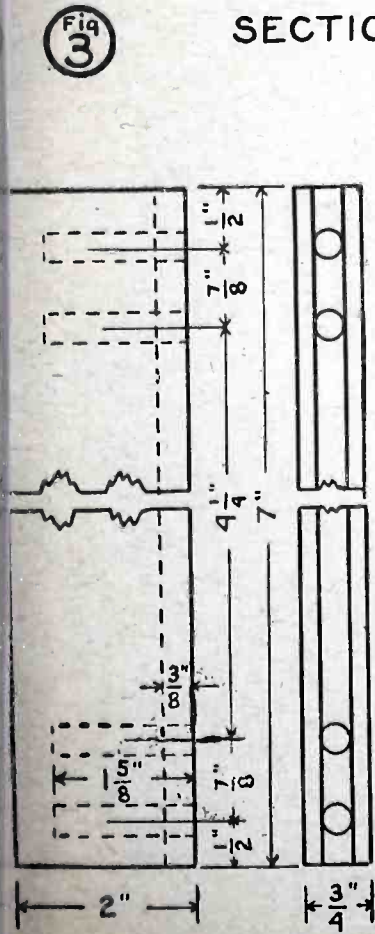
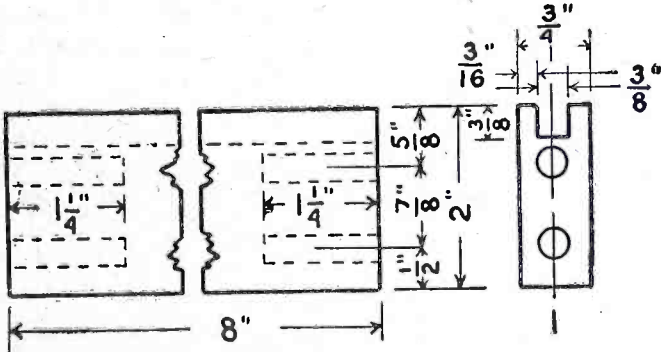


Fig 13 SHELF NOSING



SHORT DOOR STILE  
2 Pairs required.



RAIL, SMALL DOOR  
6 Required

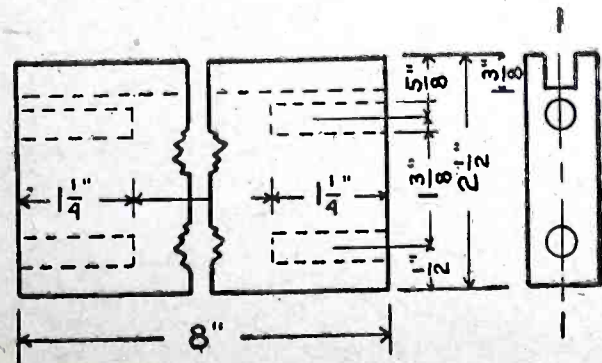
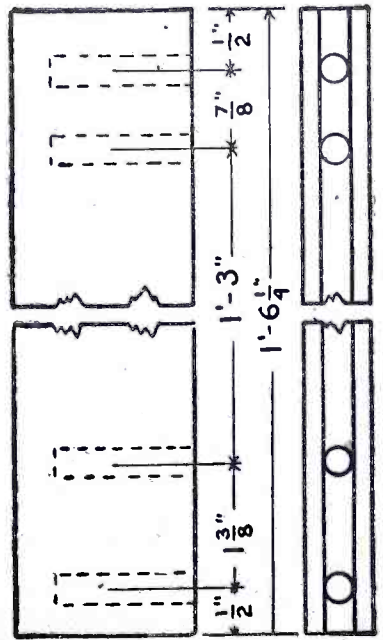
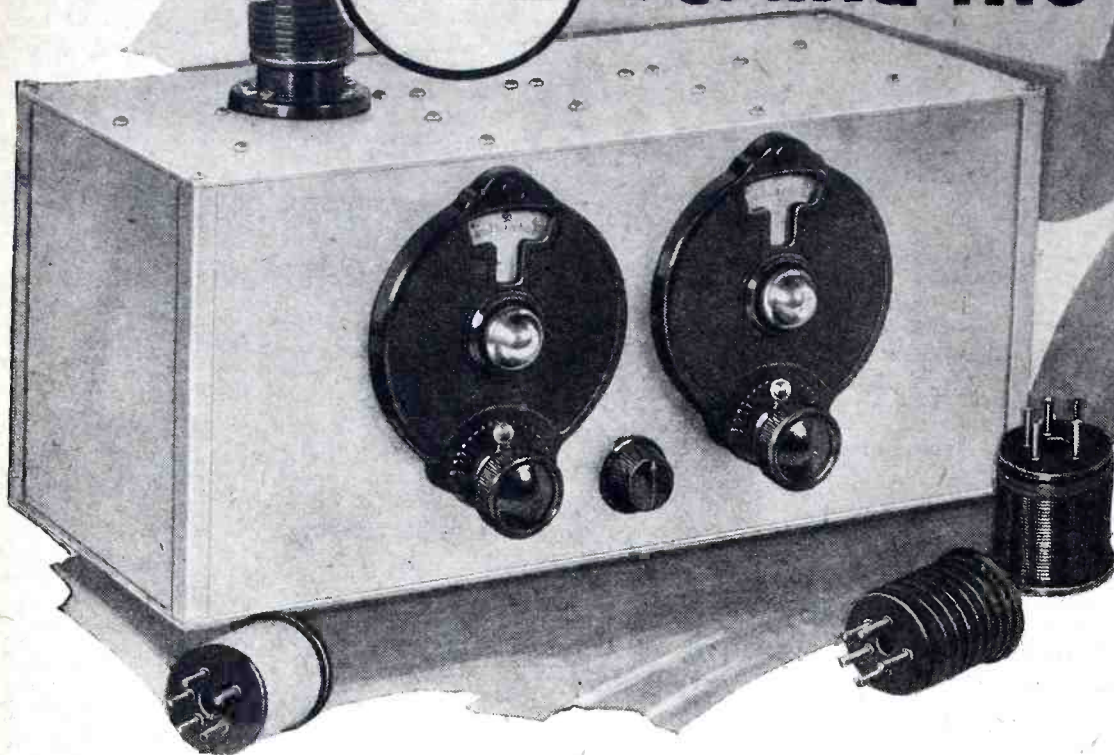


Fig 14 LOWER RAIL - LONG DOOR  
2 Required



LONG DOOR STILE  
2 pairs required

# The "SM" Round-the-World-Four



THE unquenchable rumors that television is here in form simple enough for home experimentation have led to increased interest, if that be possible, in short wave reception. Many of the experimental television transmissions take place on short waves, such as that from WRNY, New York and WLEX, Boston, Mass. A short wave receiver was used in these experiments, and it is certain that no matter what the form, television impulses must be tuned in upon receivers of more or less conventional design, but of a higher degree of performance than is necessary simply for short-wave code reception.

The short wave receiver illustrated and described herewith provides this higher degree of performance, plus freedom from radiation, for the oscillating detector is isolated from the antenna by a screen-grid R.F. amplifier tube. While the average three-tube short wave set will have ample sensitivity for code signals when in an oscillating condition, the performance when not oscillating is seldom, if ever, satisfactory for modulated or telephone reception (broadcast programs for instance). This is because of the fact that amateurs, interested primarily in C.W. code signals heterodyned by an oscillating detector, have taken little or no pains to obtain the smooth regeneration control absolutely necessary to satisfactory modulated signal reception. In the development of the four-tube set illustrated, great care was taken to obtain smooth regeneration control; telephone broadcast programs weakly heard, if at all, on ordinary short wave sets are satisfactorily tuned in on this receiver with considerably greater strength due to careful design and layout and to additional amplification provided by the screen-grid R.F. amplifier tube. This R.F. tube does not add a tuning control, its input circuit being untuned, yet it boosts telephone signal volume quite a lot, and entirely

eliminates "dead spots" at which the set will not oscillate, since it effectively isolates the antenna from the sensitive detector circuit.

## LIST OF PARTS

- 1 S-M 317 or Amsco .00014 tuning condenser, C1
- 1 S-M 316B or Amsco .00035 tickler condenser, C2
- 1 each S.M. 131-T, 131-U, 131-V, and 131-W coils, L2
- 1 S-M 512 5-prong socket
- 2 S-M 277 R.F. chokes, L1, L4
- 1 S-M 275 R.F. choke, L3
- 1 S-M 818 hook-up wire (25 feet)
- 1 S-M 734 aluminum shielding cabinet with terminal strip
- 1 S-M 255 first stage A.F. transformer, T1
- 1 S-M 256 second stage A.F. transformer, T2
- 3 S-M 311 tube sockets
- 1 Yaxley 20-ohm midget rheostat, R4
- 1 Yaxley 500 switch attachment, SW
- 2 Yaxley insulated tip jacks
- 1 Na-Aid 481XS spring socket for detector
- 1 Polymet .00015 condenser, C5
- 1 Polymet .002 condenser, C6
- 1 Polymet .005 condenser, C4
- 1 Polymet grid leak mount
- 1 Polymet 5 megohm grid leak, R3
- 1 Durham 50,000 ohm resistor, R5
- 1 Sprague ¼ mf. condenser, C3
- 2 Carter H-10, 10-ohm resistors, R1, R2
- 1 Carter H-2, 2-ohm resistor, R6
- 8 binding posts consisting of 8/32 screw, nut, and insulated top
- 2 National type B vernier dials.

An unusual degree of smoothness of regeneration control, freedom from "putting" and "fringe effect" as the set goes into oscillation is effected by careful circuit and coil design, notably by using a small coil, which on the lower waves (particularly around 20 meters and be-

low) provides smoother and sweeter control than the two, three, and even four inch short wave coils generally used. T

coils are actually a refinement of the popular "tube base" or "Scottish" id which has been found to give such excellent and economical results. These forms are slightly larger and longer than the average tube base, by dimensions sufficient to allow more efficient coils than are possible on the ordinary tube base (often not available except at the expense of breaking good tubes). A winding space 1½" long and 1½" in diameter is available, with tickler slot ⅛" deep and 1/16" wide at the filament end. On the bottom of the moulded form are five hollow pins properly positioned to fit any five-prong A.C. tube socket. These coil forms are so inexpensive that any number of experimental coils for different wave bands can be wound at little cost, to be tuned by any size of condenser that may suit the builders' fancy. In this matter of "builders' fancy," however, it is well to incidentally remark that, while a code receiver can be thrown together almost any old way and still work, physical placement of parts and wiring details must be most rigidly watched in order to get a good modulated signal receiver.

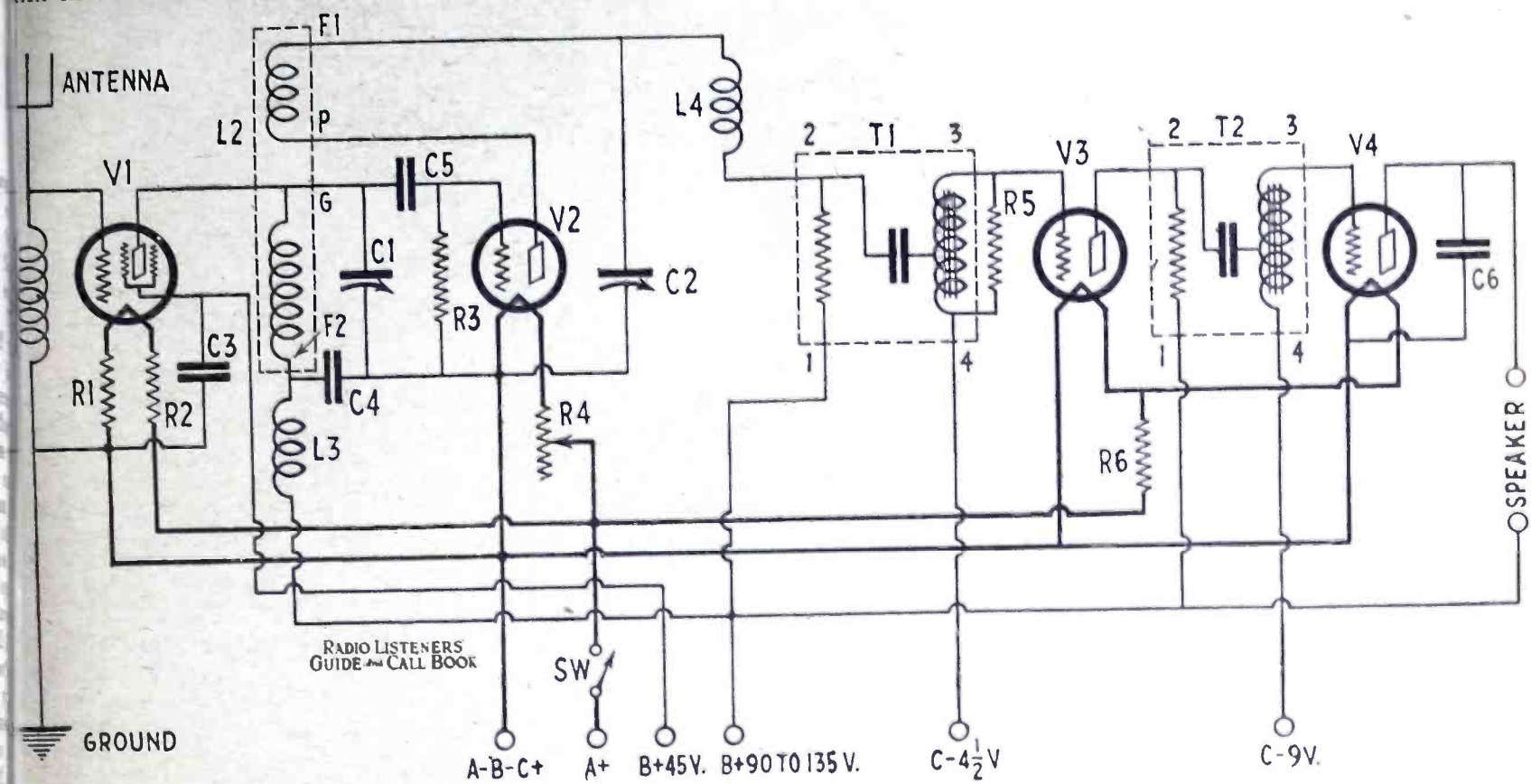
The set illustrated is mounted on the top and front of a satin-finished aluminum cabinet, 14" long, 6" wide, and 6" high, with all parts placed in a simple straight line as in a schematic diagram instead of being tied up in a knot difficult of assembly and "trouble shooting." Looking at the inside of the receiver with bottom and sides removed, the antenna choke coil is seen at the left; next to it is the screen grid R.F. tube socket, then the screen grid tube by-pass condenser and plate choke. The 5-prong coil socket is mounted on the other side of the top on 1" studs, directly above the screen grid tube socket and by-pass condenser. Next is the grid leak and detector socket, with the tuning condenser directly in front of them; then the plate choke, regeneration condenser, two audio tube sockets, and two S-M Clough-type audio transformers. A 20-ohm rheostat with switch attachment is placed on the panel to control detector filament voltage. All binding posts and speaker tip jacks are mounted on a small bakelite strip at the rear of the cabinet.

National vernier dials are used. The matter of a good short wave variable condenser is an interesting one, for few good broadcast condensers, even of properly reduced capacity, are good at 20 meters and below, for bearing noises develop to

annoying degree. A noisy broadcast of condenser can often be quieted short wave use by insulating its bearings, at increased cost and labor. However, the type of compression bearing used in the Amsco and Silver-Marshall

ground can be obtained by connecting direct to any mounting screw fastening of the aluminum cabinet. All wiring should be short, direct, and well soldered, and care taken to avoid the possibility of "closed loops" of wiring which would

The parts used in the model are listed above, and are all standard parts selected for their high quality. The circuit was carefully designed around them to make sure that all builders will obtain the same results in spite of minor variations bound



Schematic wiring diagram of the S-M "Round-the-World Four." A 222 type tube is used in socket V1; two 201-A's in V2 and V3 and a 112-A in V4.

condensers is quite quiet at 20 meters, and offers all the advantages of a good mechanical bearing of brass and steel, yet perfectly quiet in operation. This feature of quiet bearings may be possessed by other types on the market as well. In building this set, the parts should be placed as shown. A short direct

pick up energy and possibly cause irregular regeneration control. The apparently unnecessary by-pass condenser, shown connected from the second audio tube plate to ground, should be used; its purpose is to cut out the stray radio frequency currents in the audio amplifier, all in the interest of a good smooth set.

to occur in home assembly; therefore substitution should be made only when absolutely necessary. (Do not substitute for R.F. chokes, coil form size and variable condensers unless willing to "smooth up" your own particular set's operation by the "cut and try" scheme of adding by-pass condensers, R.F. chokes and resist-

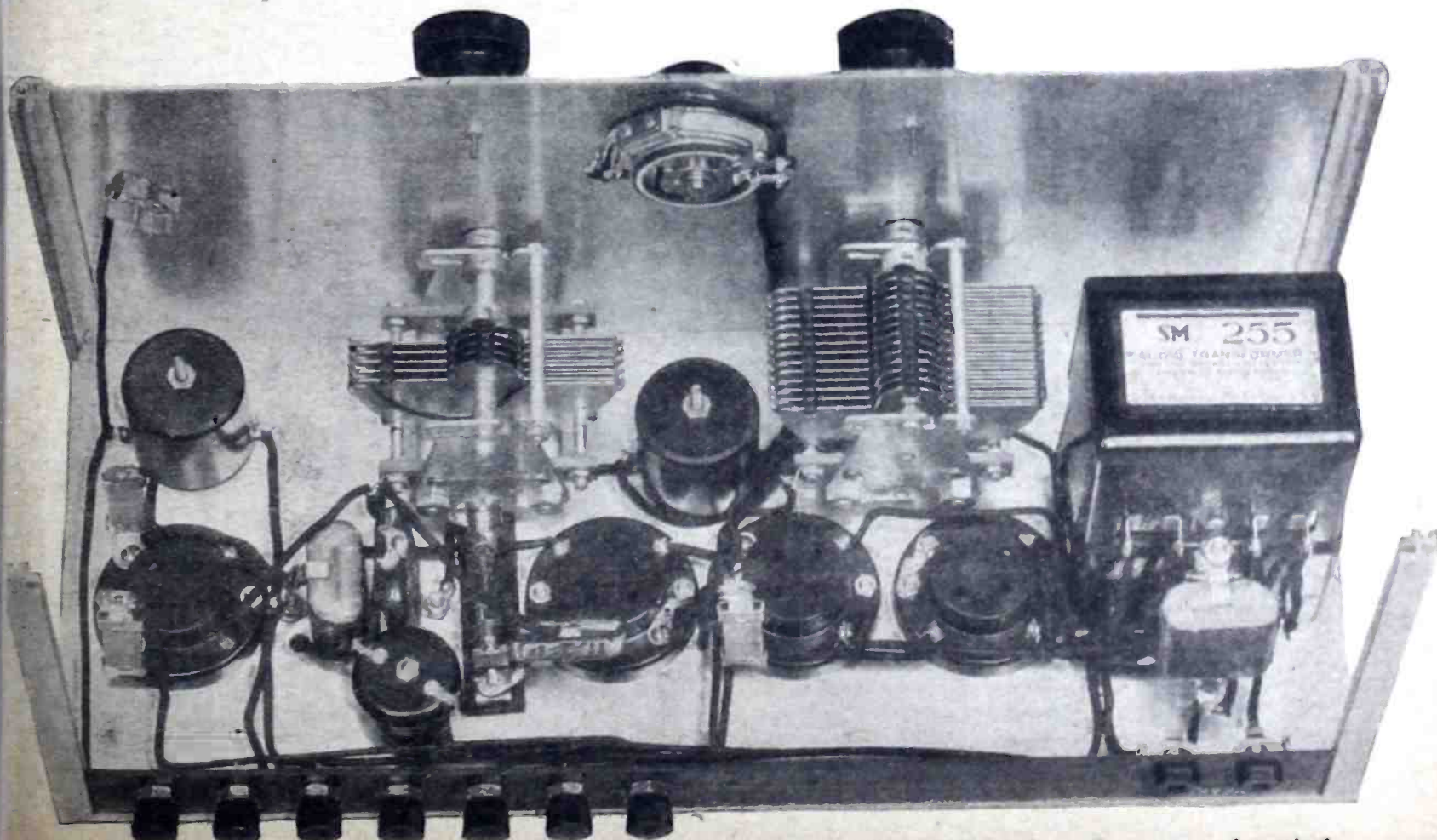
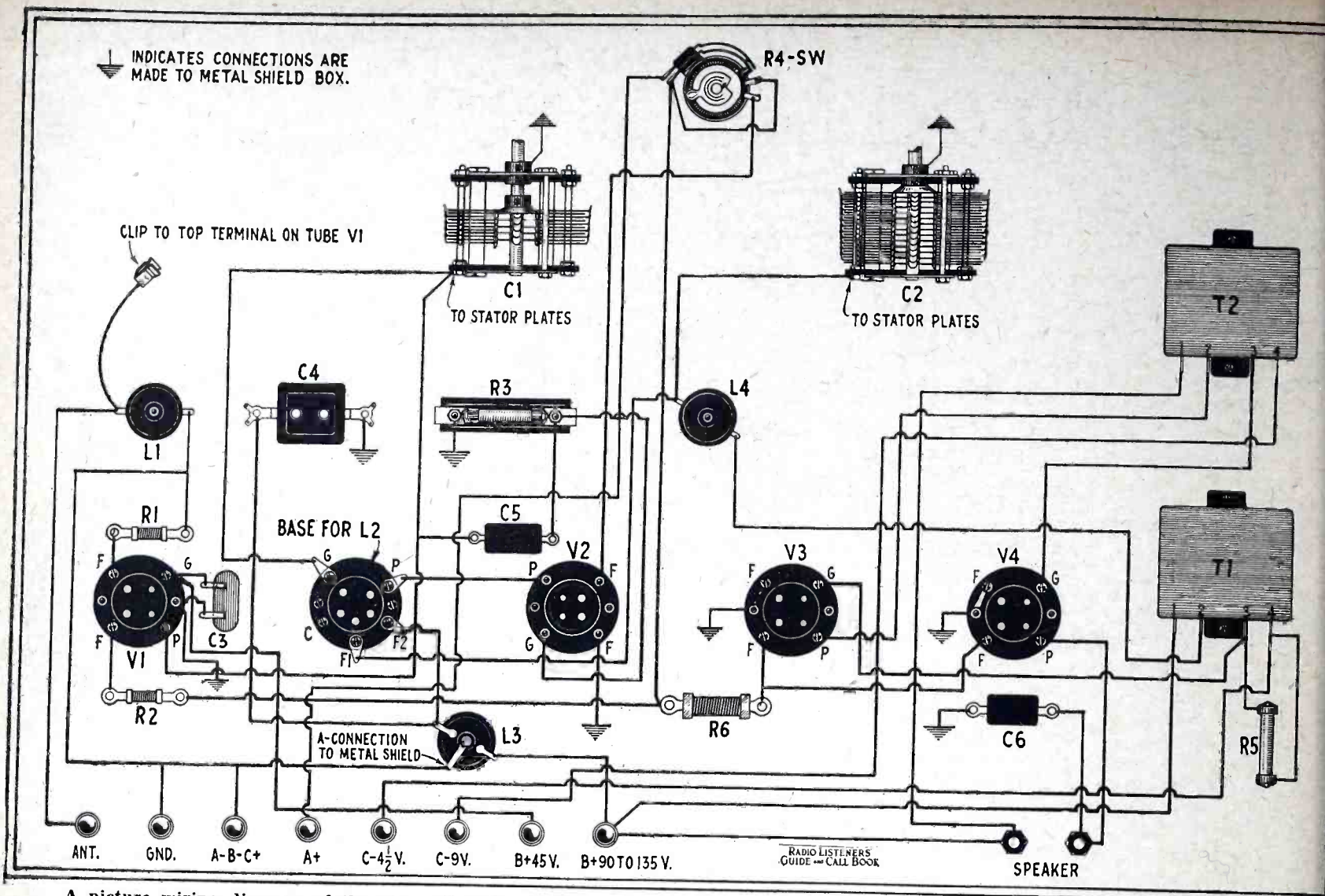


Photo of the set with the back and sides of the shield casing removed to show all the parts as they appear when wired.



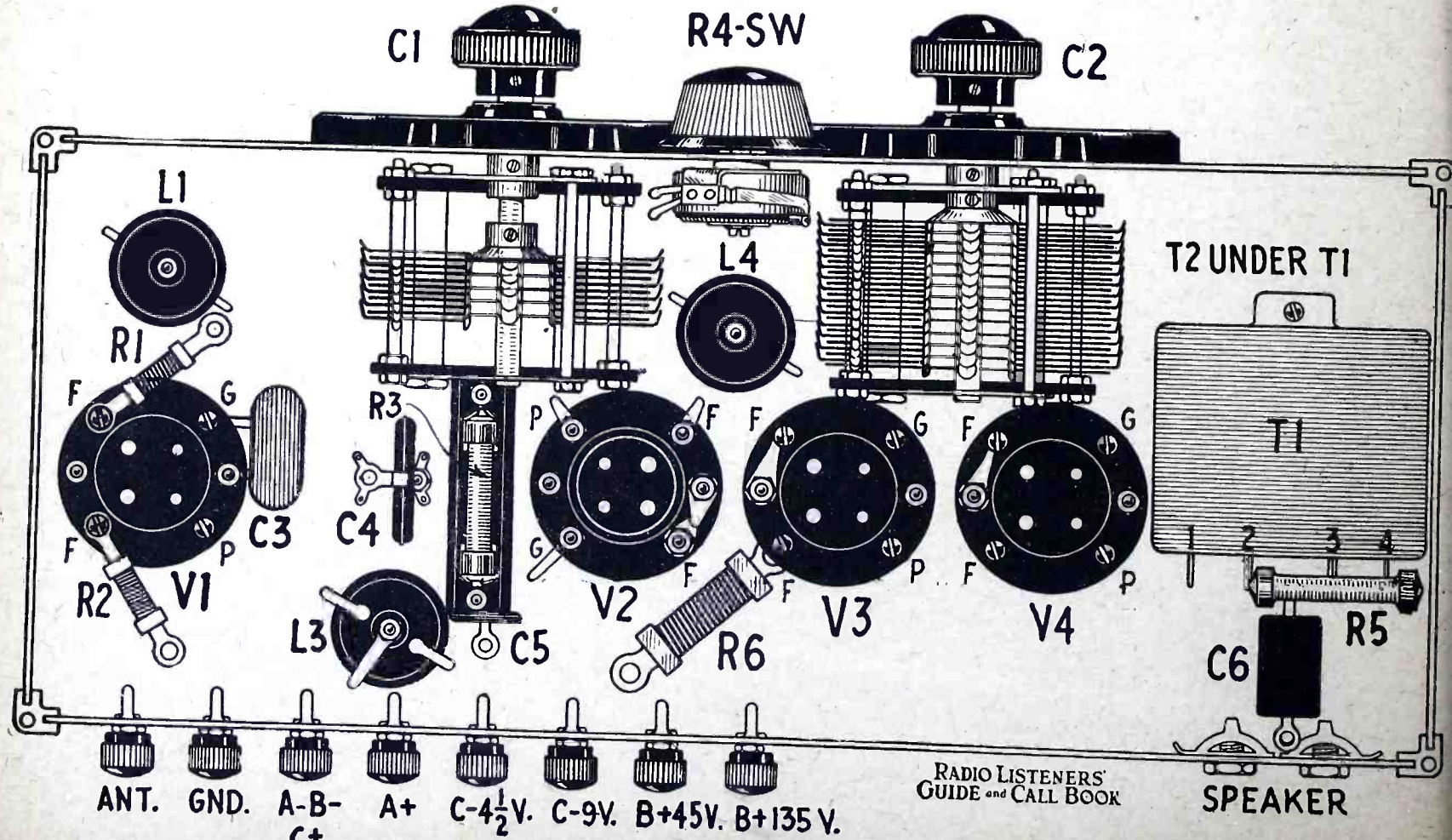
A picture wiring diagram of the set. All parts are indicated to correspond with the list of parts, schematic diagram and layout.

tors at needed points and trimming coils —or unless you are only interested in code reception.)

The coils are all wound on the same type of Silver-Marshall forms, with No. 34 D.C.C. wire for the ticklers, and No.

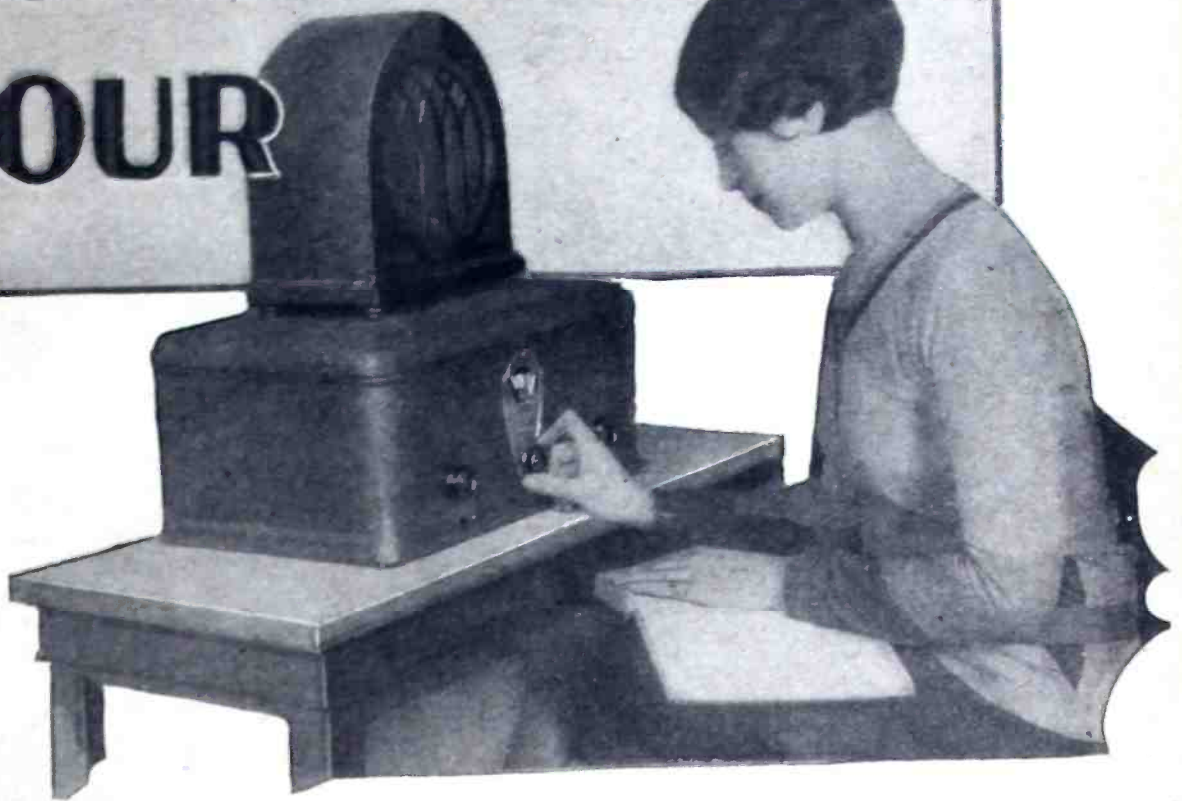
22 P.E. wire for the secondaries (except the large coil which uses No. 24 D.C.C.). All secondaries have turns so spaced that the windings cover the full 1 1/2" of form space. The windings are so connected that the top or start of the secondary termin-

ates in the "G" post of a standard 5 point tube socket, and the bottom or end in the right-hand "F" post (the "F" post nearest the "P" or plate post). The slotted tickler, wound in the same direction, (Continued on page 110)



This is the layout of parts showing the location of each component. Note the neat compactness of the entire arrangement.

# THE AERO METROPOLITAN A.C. FOUR



EVER since tuned radio frequency amplification has been practical the most popular receiver and certainly the one which holds all the distance records has been the four-tube set incorporating a stage of tuned radio frequency, usually neutralized, a regenerative detector, and a good two-stage audio frequency amplifier. This combination made its initial debut as the "Roberts Reflex," closely succeeded by the "Browning-Drake." Probably the major reason for the success of this particular type of receiver has been its simplicity and comparative inexpensiveness to build, of course, combined with its amazing sensitivity.

The records, for instance, which have been established by these receivers are more than just marvelous, they are astounding. It has long been a fallacy of science that a regenerative detector operating just a hair below oscillation would be absolutely without limit in its ability to pick up distance. Practical construction troubles take quite a few miles off the infinite distance which it is theoretically able to obtain, but on the other hand, the single stage of radio frequency seems often to add on those same few miles again and give the set a limitless range.

The greatest drawback to such receivers in the past has been the difficulty in properly neutralizing the radio frequency amplifier tubes, but the development of the shield grid tube has opened up a wonderful new field for this receiver. This tube which has been especially designed for use as a radio frequency amplifier eliminates all of the inter-electrode feedback through coupling between the grid and plate due to the capacity of these two elements. This makes it possible to obtain considerably higher voltage amplification per stage than is possible with an unneutralized tube of the ordinary three element variety.

Due to the structure of the tube the plate current does not change to any great extent with variations in the voltage applied to the plate. As a result the amplitude of the plate current change caused by variations of the grid voltage is to all intents and purposes absolutely unaffected by any changes in the load resistance and therefore, it is possible to use a tremendously high impedance in the plate circuit with the resulting high voltage amplification obtainable by the use of this very large load. In this tube the

voltage amplification in the final analysis is only dependent upon the mutual conductance of the tube itself and the load.

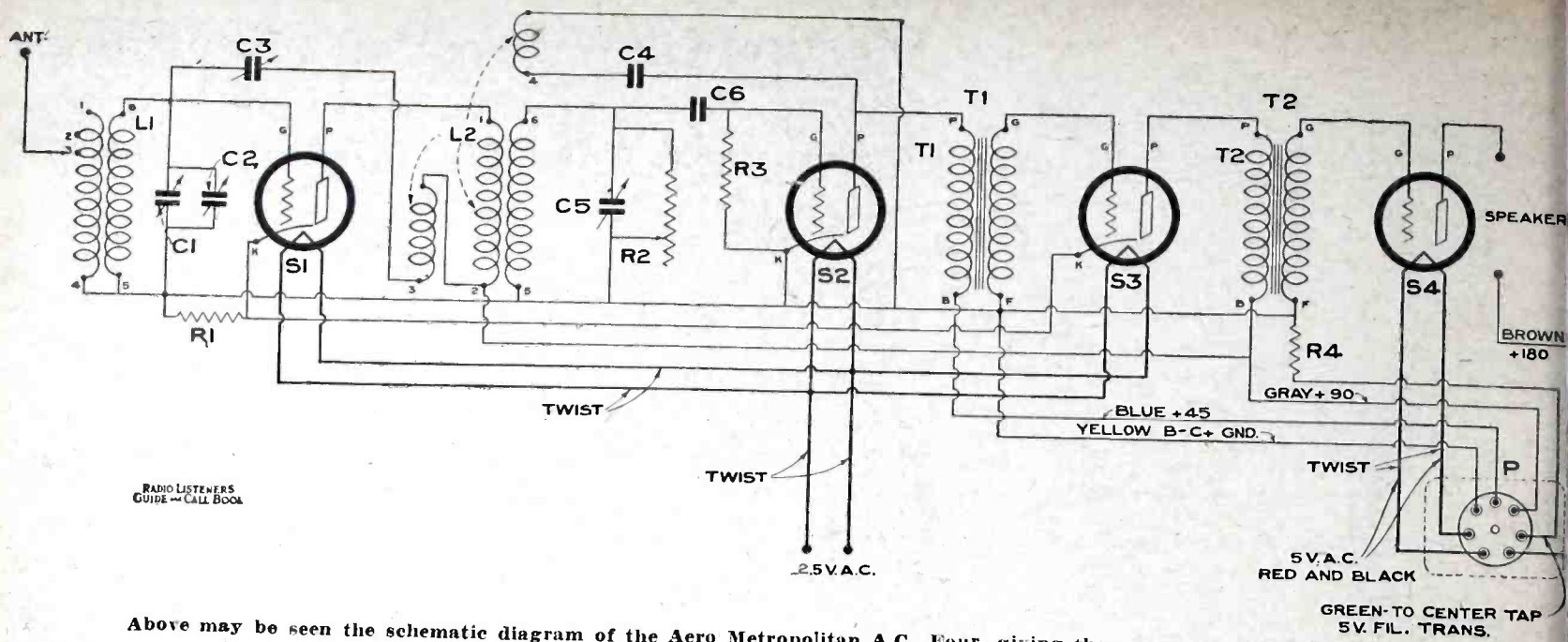
## LIST OF PARTS

- 1 Aero special 2 gang condenser, .0005 mfd., C1, C5
- 1 Aero special midget condenser, C2
- 1 Aerovox moulded mica condenser, .00025 mfd., C6
- 1 Aerovox moulded mica condenser, .001 mfd., C4
- 1 Yaxley No. 660 cable connector, P
- 1 Yaxley No. 7800 resistance, 800 ohms, R1
- 1 Yaxley No. 72,000 resistance, 2,000 ohms, R4
- 1 Yaxley No. 422 tip jacks
- 1 Aero coil kit, U-273, L1, L2
- 1 National illuminated dial, type E
- 3 Kurz-Kasch walnut knobs
- 2 Aero type AE-770 transformers, T1, T2
- 3 Eby binding posts
- 1 Allen-Bradley 3 megohm grid leak, R3
- 1 Aero special type AE-250 Centralab resistor, R2
- 3 Aero bushings for dial shaft
- 1 Roll Corwico Braidite hook-up wire
- 1 Aerovox type BC-280 condenser block
- 1 Radiart No. 44 power unit with auxiliary terminal board
- 1 Aero metal cabinet for Metropolitan A.C. Four.

The voltage across the output load is directly proportional to the load, and therefore when a circuit can be employed which will have a large reactance, an unusual degree of amplification can be obtained. At the lower radio frequencies such as are ordinarily used for superheterodyne intermediate amplification this high load can be easily built up but at broadcasting frequencies it is rather difficult to obtain a

very high load impedance and still retain selectivity. For example, it is possible to obtain the desired high load by the use of a tuned plate circuit such as would cause an ordinary tube to become an oscillator of the first magnitude, without causing such disturbances, but there are drawbacks to this system, which has been very extensively employed with the tube up to the present. In the first place the selectivity of this combination is extremely poor since the large losses incurred in both the plate circuit of the shield grid tube and the grid circuit of the following tube are placed directly across the tuned circuit and broaden it tremendously. In addition this direct coupling allows low frequency disturbances to pass through the tubes without a great deal of difficulty and such a connection very frequently causes motor boating and other similar audio frequency oscillations, due to resistance acting as coupling resistors, and making the radio frequency amplifier effectively an audio frequency oscillator.

The use of a radio frequency transformer or autotransformer of the proper type will block out the transmission of these low frequency disturbances, but this transformer must be designed with unusual care in order that the optimum load impedance may be obtained without too great a loss of selectivity and at the same time result in an almost even transmission of energy between primary and secondary over the entire broadcast spectrum. There is another complication which enters here. This is the matter of coupling the plate of the regenerative detector to the grid coil as well as coupling from the plate of the preceding tube. In the case of an ordinary tube, the self inductance of the primary coil used is comparatively small and the mutual inductance of the primary and tickler is utilized and an entirely different phenomenon oc-



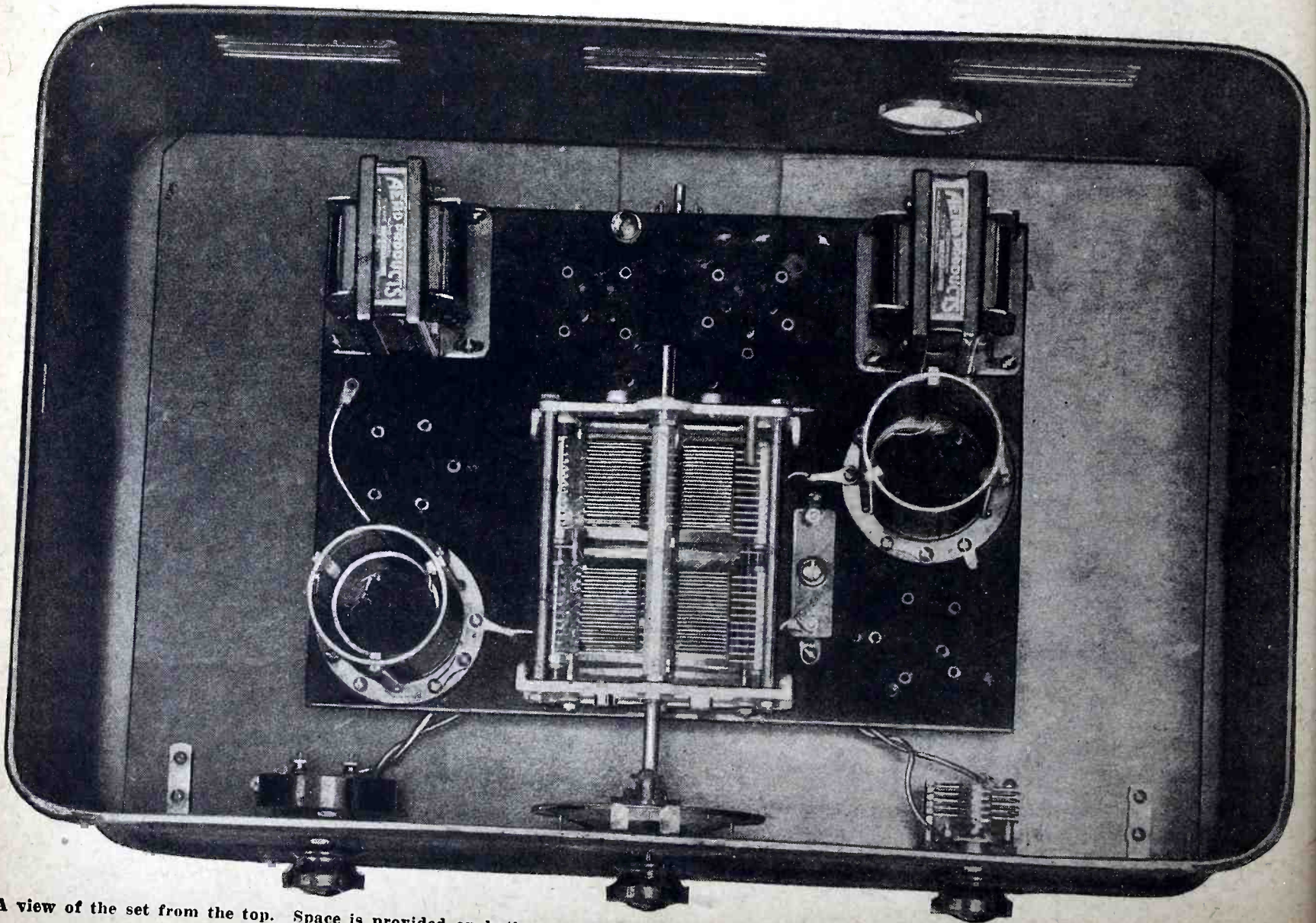
Above may be seen the schematic diagram of the Aero Metropolitan A.C. Four, giving the necessary details for wiring.

regeneration is actually reduced and vice versa.

regeneration is actually reduced and vice versa. The inductance coupling between both the primary and tickler coils and the secondary must be in phase. In this case, of course, coupling between the tickler and primary would cause voltage in each other in quadrature, varying the load impedance of the detector tube considerably. In actual practice very mystifying actions take place until the reason is discovered. For example, it will frequently occur in an improperly designed coil that when the coupling between the tickler and the secondary is increased the

regeneration is actually reduced and vice versa. A protracted course in experimentation finally resulted in the design of a coil which not only placed the requisite load in the plate circuit of the shield grid but at the same time has an excellent figure of merit in selectivity and operates to great advantage as a feed-back coil. The use of this coil has made possible the excellent results which are to be obtained from the Aero "Metropolitan Four." With this coil as a base, the circuit shown in the wiring diagram herewith has

been developed. The antenna coupler is of a type which allows an adjustment of the primary inductance to match antenna characteristics, and in order to keep the radio frequency resistance at the lowest possible figure, instead of introducing a separate primary which not being entirely connected at all times in the circuit would have a shorted turn effect, a portion of the secondary is used in an auto transformer arrangement. For great selectivity with any type of antenna, the antenna is connected to tap No. 1 while for greater sensitivity or short antennas,



A view of the set from the top. Space is provided on both sides of the chassis for the condenser block and power unit as described in article.

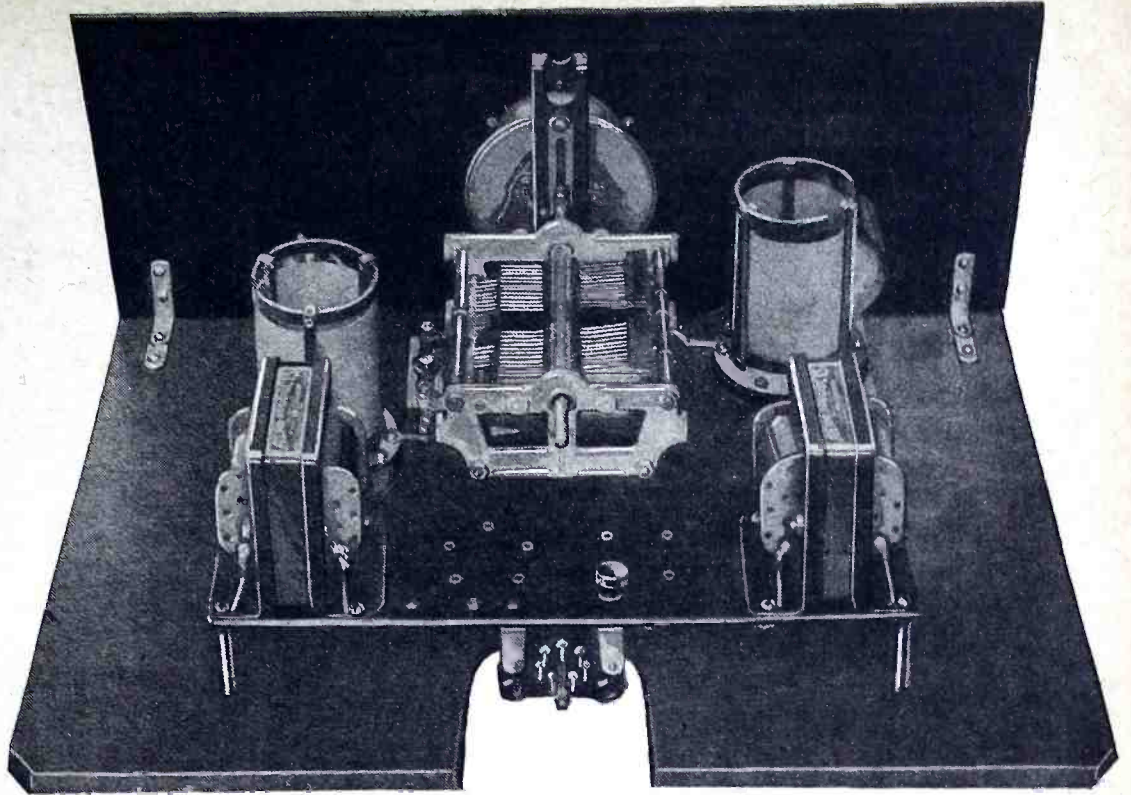


tap No. 4 is used. Regeneration is accomplished by a constant feed-back through a fixed tickler coil, and a resistance across the tuning condenser of this stage serves to subtract sufficient energy from the circuit to stop oscillation and then become a volume control, permitting the voltage on the grid of the detector tube to be reduced to zero if desired. This shunt resistance across the condenser has the same action as a series resistance in the oscillating circuit. The relation is obtained from the relation

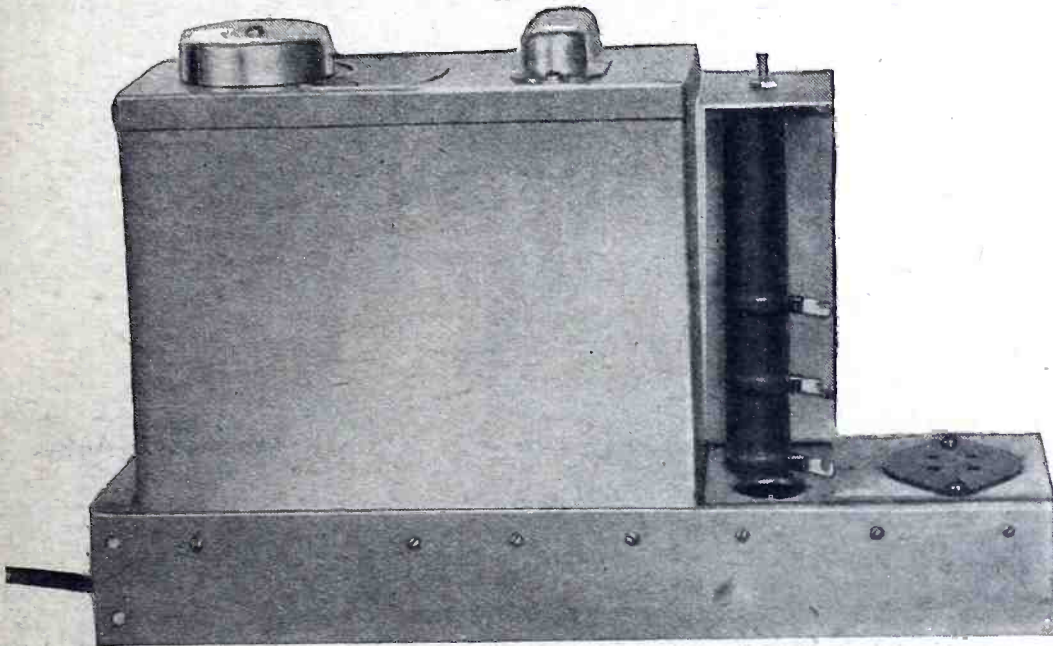
$$r = \frac{1}{W^2 C^2 R}$$

Where R is the series resistance and r the shunt resistance.

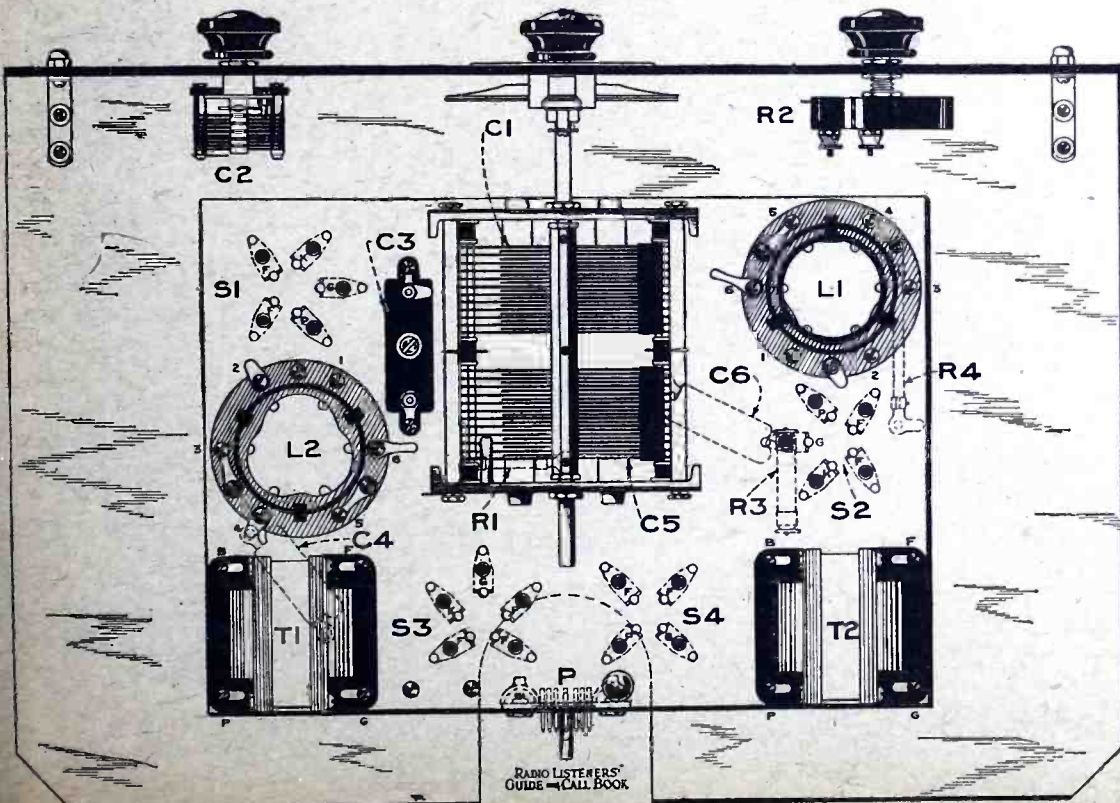
The adoption of this method of regeneration rather than a variable feed-back was caused by the tendency of any variation in coupling between the plate and grid circuits to slightly detune the circuit and when a ganged condenser is utilized this cannot be tolerated. Furthermore, the absorption method used provides an extremely smooth method of control and at the same time makes possible the reduc-



Above is a photo of panel and baseboard construction which may be desired by the builder.



The special Radiart power unit used in connection with the set.



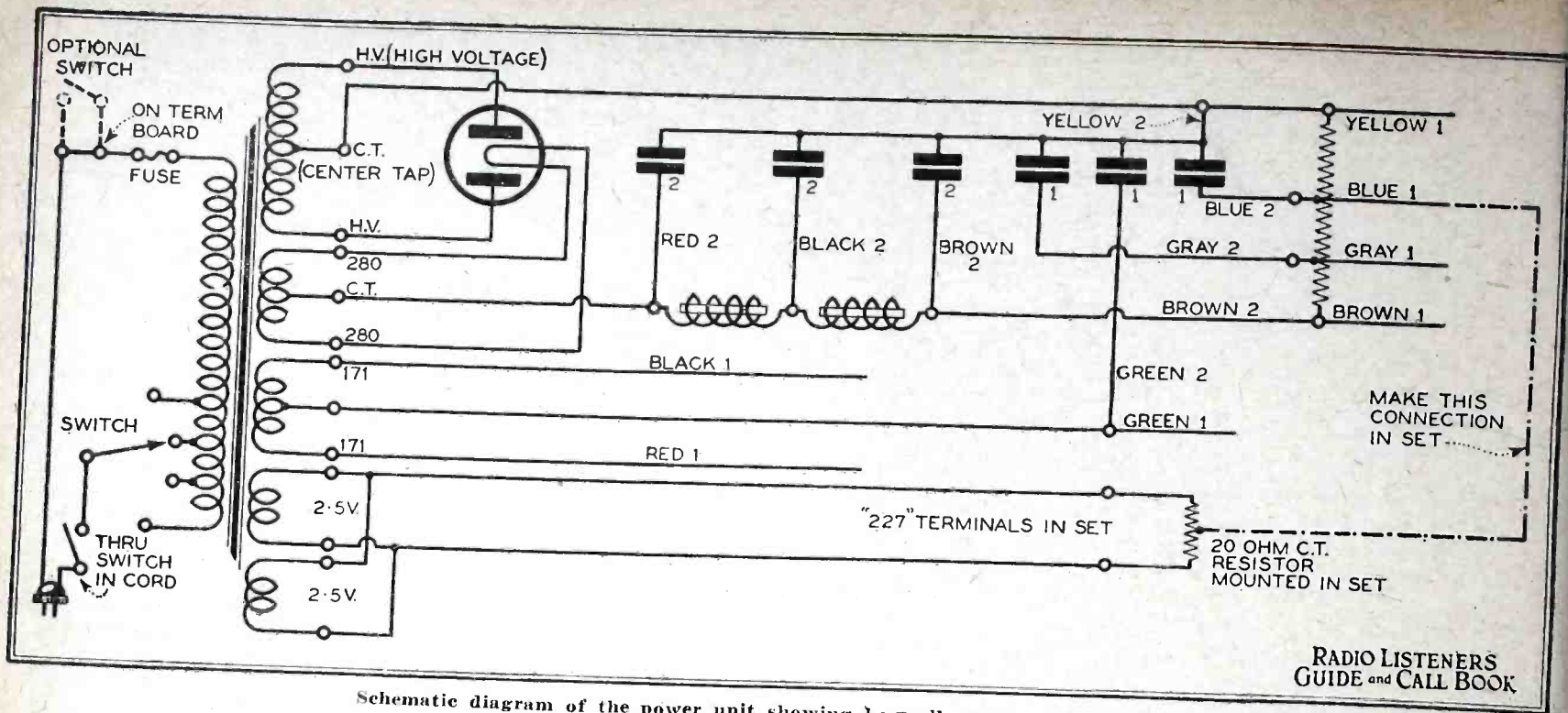
Detailed layout of the set built up on a sub-panel and baseboard with bakelite front panel.

tion of the volume to zero, by the same instrument which controls regeneration, thus simplifying operation considerably.

A new type of audio frequency amplifying transformer was built into the receiver—that is, new to the general public. For sometime the line amplifiers used in bringing programs over the long telephone net works have been equipped with an especially wound transformer. Standard audio frequency transformers of the better grade have a fairly flat amplification curve extending from 30 to 50 cycles at the low end to five or six thousand at the high end and then tapering off very gradually, continuing to give an appreciable amount of amplification further into the band between 50 and 100 kilocycles. This is very undesirable. Sounds about 7000 cycles are of no value in reproduction and amplification of such high frequencies serves no useful purpose, and at the same time causes much of the "static" and other noises heard in a radio receiver. A good illustration is the "needle scratch" of a phonograph. This objectionable noise can readily be filtered out of an electrical reproducer because the frequency of its components averages well above 7000 cycles. No detraction from the quality of reproduction is audible but there is a great relief when the background of scratching and hissing is eliminated.

The Aero audio transformers have an amplification curve even flatter than usual from 30 to 7000 cycles and then have a sharp cut-off amplifying frequencies above 7500 cycles not at all, and as a consequence their use in this receiver has resulted in extremely quiet operation with almost complete silence when no music is being broadcast. The usual background of "popping" and of "squishing" is totally absent and for the first time the home-built set can have as quiet and perfect audio frequency amplification as the broadcasting station.

This kit is supplied complete or in parts. A handsome metal cabinet with a variety of handsome finishes is supplied and the kit itself contains every part down to the soldering lugs and pieces of



Schematic diagram of the power unit showing how all components are wired.

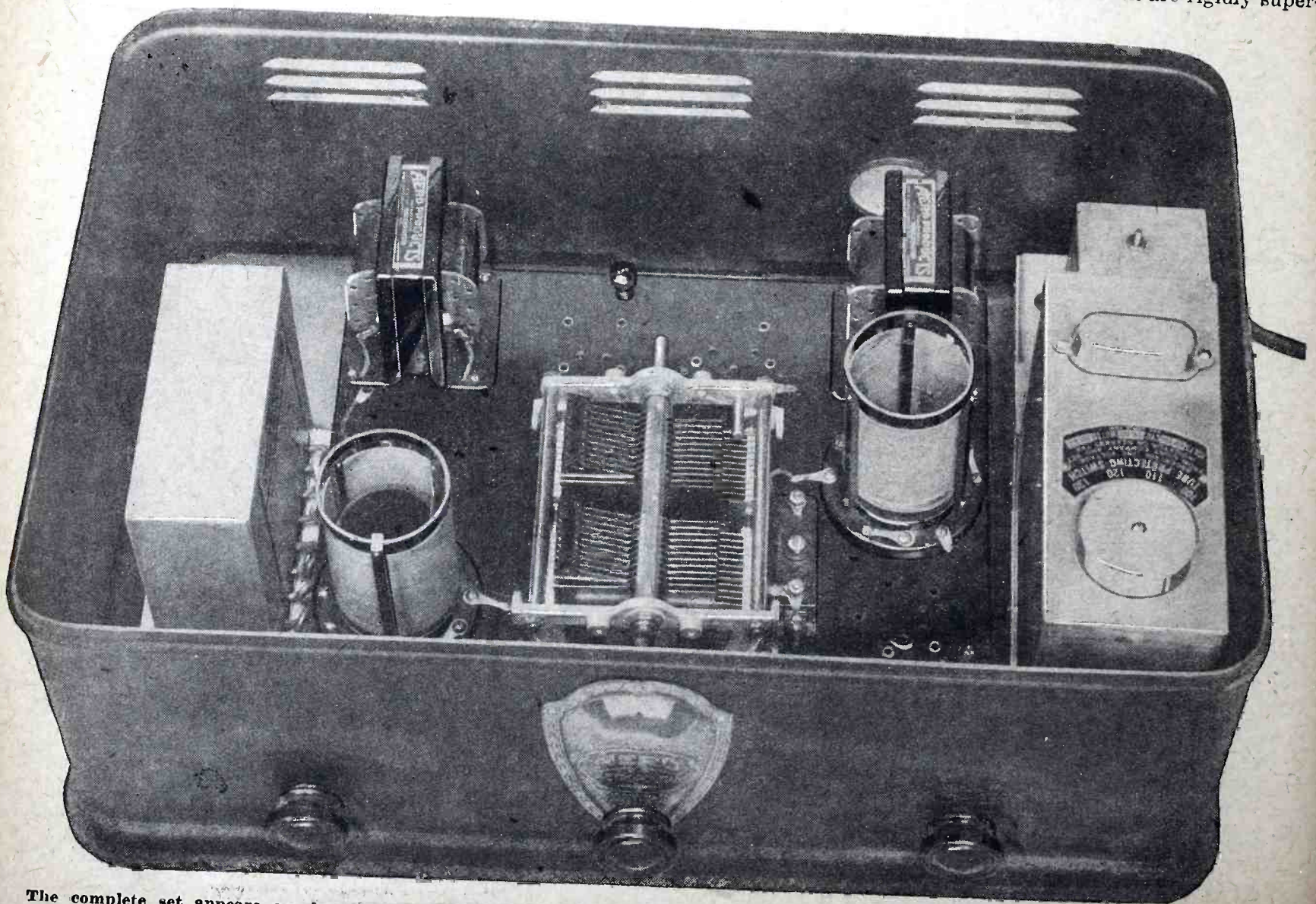
hook-up wire and machine screws necessary for its assembly. Room is provided in the cabinet for the especially designed Radiart power unit as shown in the photo.

The Radiart unit is installed on the right side of the set and an Aerovox BC-280 condenser block is placed in the space at the left. The method of wiring the power unit in the circuit is shown in the accompanying diagrams. This unit supplies the filament current for all of the

tubes including all necessary "B" voltages. It also supplies a negative "C" bias of 40 volts for the 171 power tube used in the set. A 280 type rectifier tube is used in the single tube socket of the unit.

Unusually complete blueprints from which the illustrations herewith were made, are supplied with the kit, and after it is completed it has all the characteristics necessary for operation in either congested metropolitan districts or for isolated country points.

In this receiver all the parts have been perfectly co-ordinated and its design has been the subject of an exhaustive research as any factory built set, but at the same time every part used in its construction will be the best that can be bought from the best manufacturers. Rather than follow the usual custom of depending upon anyone who is a set builder, fifteen stations in the whole country have been established for the Aero "Metropolitan" Receiver, and these fifteen are rigidly super-



The complete set appears as shown above. The block condenser is placed in the space at the left and the power unit at the right.

vised by the sponsors of this set with the result that the builders can absolutely depend upon first-class service.

For those who wish a comparatively inexpensive receiver with all the good points of the shield grid "Metropolitan" A.C. Receiver has been designed. In its physical characteristics it is almost identical with the shield grid model, while in the design of the key coil, it follows almost exactly the original specifications of Doctor Walter Van Bramm Roberts, designer of the Roberts Reflex Receiver which undoubtedly has been the outstanding receiver of the past five years. Each one of these coils contains a combination primary and neutralizing coil, consisting of two windings wound in slots so that absolute accuracy is maintained. Very fine wire is used and a wide spacing is maintained, reducing the distributed capacity to a minimum and gaining the highest coefficient of coupling compatible with a retention of selectivity. The form of winding in the combination coils results in a coefficient of coupling between the primary and neutralizing coils approaching unity, with consequent great simplicity of neutralization.

In the A.C. model no "C" battery is

required as all the biases are automatically taken from the B unit by means of the eight hundred and two thousand ohm resistors. If it is desired to use an

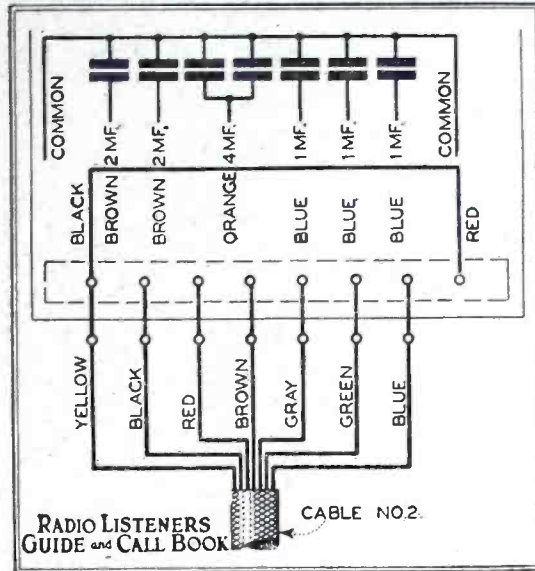


Diagram of the connections to the block condenser from the power unit.

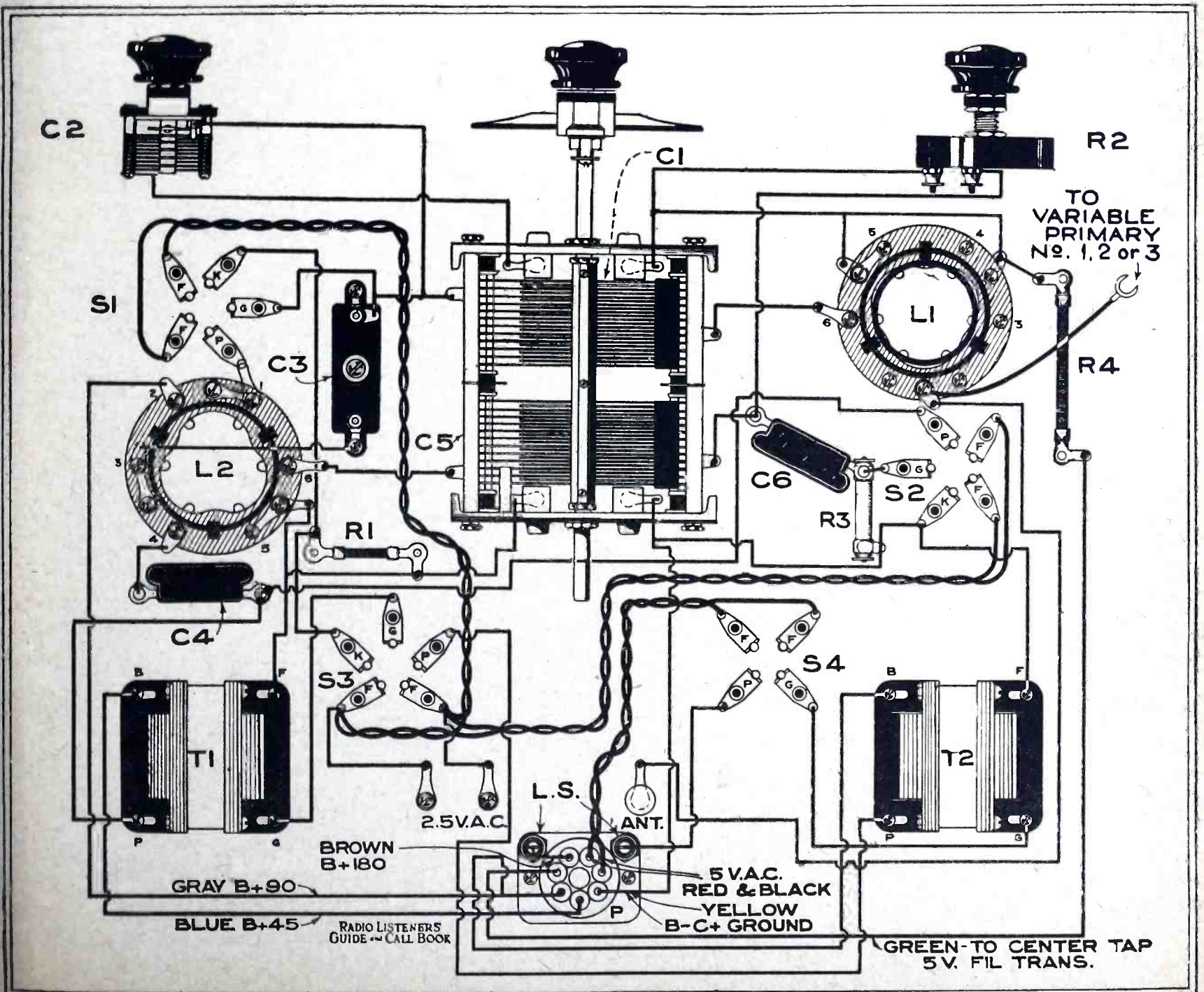
additional C battery on the last tube, it is recommended rather that the B battery be increased by that amount. The ninety-volt tap can be increased to one hundred

and thirty-five volts without any danger of trouble and the one hundred and eighty volt tap can be operated with two hundred and twenty-five volts in the case of a 171 tube. The A.C. set is adaptable for use with a UX-210 or 250 power tube if desired. In the event it is desired to use either of these, 7½ volts should be supplied to the red and black cords of the Yaxley cable and the brown lead should be taken to plus 500 volts.

When using a speaker which does not contain some variety of output device, the latter should always be applied externally? The purpose of using this device is to prevent overload on the speaker.

The third drawing shows the connections to be employed when standard D.C. tubes are to be used throughout. The same coil already mentioned as having been made up for the A.C. set is employed as a key unit and will operate to excellent satisfaction with a 199, 112 or a 201-A tube.

The use of a Hi-Mu tube in the first audio stage is highly recommended in both the shield grid and D.C. models. It is a tribute to the great excellence of the Aero Transformers that an actual gain (Continued on page 116)



Picture wiring diagram of the Metropolitan A.C. Four. All terminals and markings on the parts are indicated consistent with the actual apparatus.

# The HAMMARLUND-ROBERTS HI-Q 29



The Master Hi-Q 29 when built according to specifications is a genuine "coast-to-coast" instrument. In selectivity nothing like it has ever been produced outside of certain laboratory instruments which are far too costly for general use. This receiver for the first time, as far as is known, employs a band-pass filter which insures flat-top, square cut-off tuning with a selectivity of 10 K.C. "Cross talk" is thereby eliminated. Only a single station can be tuned in at one time, even in large cities where many high-powered stations are broadcasting at once. Stations do not slide in gradually with a gradual increase in volume, they *snap in*—clear and undistorted.

Fidelity of tonal quality and absence of distortion have always been features of Hammarlund-Roberts receivers and again this year the Master Hi-Q 29 will bear the same scrutiny as would its fore-runners. The signals are clear and can be modulated to whatever degree of volume desired.

The Master Hi-Q 29 has been so designed that it can be constructed with a minimum of effort on the part of the builder. The accompanying diagrams and illustrations will furnish the builder with complete details, which should be adequate to the enthusiast of average experience.

It is a well-known fact that the prime requisites for a first-class modern receiver are quality of reproduction, selectivity and sensitivity and that they are by no means independent of each other. They are closely bound theoretically with the design of the whole and it is for this reason that only the best receivers have all three features. The new Hammarlund-Roberts receiver possesses these three requisites to a remarkably high degree and a careful study of the principles employed in the design will reveal the reasons for the exceptional operating qualities.

The Master Hi-Q 29 uses a remarkable circuit which is entirely new in radio receiver design. The underlying principle is described by Morecroft in his book, "Principles of Radio Communication" in the section devoted to "coupled circuits." When such a circuit is used in a receiver it is quite obvious that the result is less radio-frequency distortion and greater selectivity. Until the advent of the shield-grid tube this type of circuit was not practical, and even with these tubes, the layout is quite elaborate and therefore only adaptable to high quality receivers in the higher price class.

Briefly, the tuning system used in the Hi-Q Master provides selectivity greater

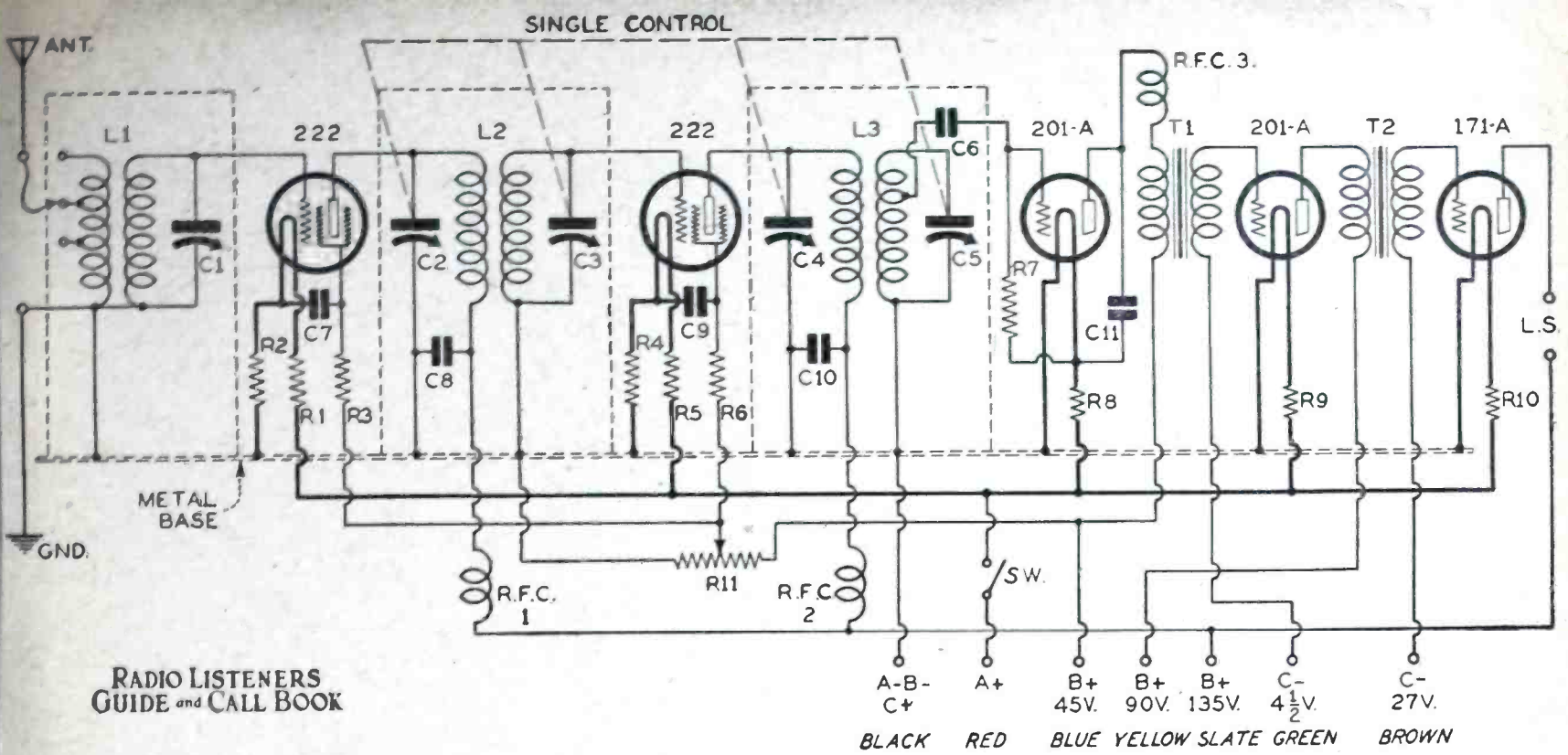
## LIST OF PARTS

- 5 Hammarlund No. ML-17 .00035 mfd. Midline condensers, C1, C2, C3, C4, C5
- 1 Hammarlund No. HQ-29 coil set, L1, L2, L3
- 2 Hammarlund No. SDW knob-control drum dials (walnut)
- 3 Hammarlund No. RFC-85 radio frequency chokes, RFC1, RFC2, RFC3
- 5 Benjamin sockets, No. 9040
- 1 Sangamo .00025 mfd. fixed mica condenser, C6
- 1 Sangamo .001 mfd. fixed mica condenser, C11
- 1 Electrad Type B, 100,000 ohm Royalty potentiometer with switch, R11, SW
- 2 Thordarson No. R-300 audio transformers, T1, T2
- 4 Acme Parvolt .5 mfd. Series 200 by-pass condensers, C7, C8, C9, C10
- 1 Durham metallized resistor, 1½ megohms, R7
- 1 Yaxley No. 660 cable connector and cable
- 1 Pair Yaxley No. 422 insulated phone tip jacks
- 3 Amperites No. 1-A, R8, R9, R10
- 2 Eby engraved binding posts
- 1 "Hi-Q 29" Master foundation unit (consisting of drilled and engraved panel, three complete aluminum shields, drilled steel chassis, shafts, binding post strips, Fahnestock clips, fixed resistance units, R1, R2, R3, R4, R5, R6, resistor mounts, brackets, clips, wire, screws, nuts, washers, and all special hardware required to complete receiver).

THERE is an old adage, "If you want a thing done right, do it yourself", but in these modern days the latter portion might be amended to read, "—have it done under your own supervision." This old saying and its modernized version applies particularly to radio receivers—either build one yourself or see that it is built according to your own requirements.

For the man who wants a receiver that will bring in the station to which he wishes to listen and bring it in so that it sounds as nearly like the original performance as is possible, the new Hammarlund-Roberts Hi-Q 29 Master Model is the end of his search. Here is a set in which is incorporated a new circuit—using band-pass filters in the radio-frequency amplifier—and an audio-frequency amplifier insuring reproduction of the highest quality. The set can be installed in any one of a number of different model cabinets or consoles, so that it can be made to fit in with almost any type or style of home decorations.

Hammarlund-Roberts receivers need little introduction to the radio fraternity as a whole because for nearly five years they have been considered among the front rank of receivers developed in the United States. The receiver herein described is by far the most efficient set bearing this name, as may be ascertained by reading the theoretical description. Improvements have been made in this new model and there are included features that as far as is known are not to be found in any other set, regardless of price.



A schematic wiring diagram of the receiver. All parts are indicated to correspond with the list of parts, layout and picture diagram.

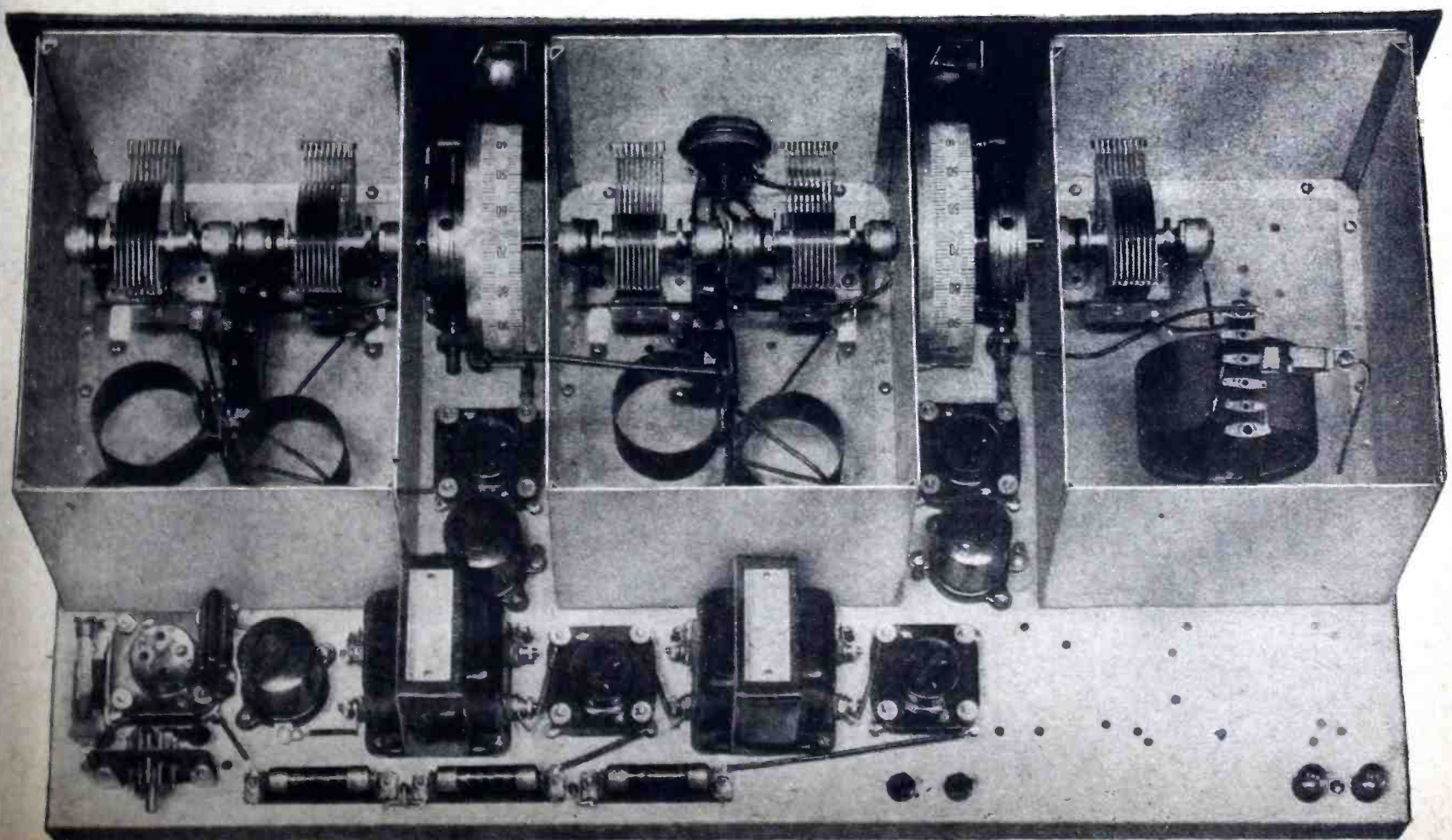
even than the old-fashioned "hair-trigger" regenerative set **EXPERTLY OPERATED**; sensitivity (amplifying power) equal to a superheterodyne and an output from the loud speaker as distortionless as that obtained from a crystal and headphones.

To start at the beginning, the layman will readily agree that good selectivity is a highly desirable attribute of any radio set. Good selectivity, however, has hitherto been understood to mean sharpness of tuning, which is not conducive to quality of reproduction. For example, the modern high-quality audio transformers now available make possible the con-

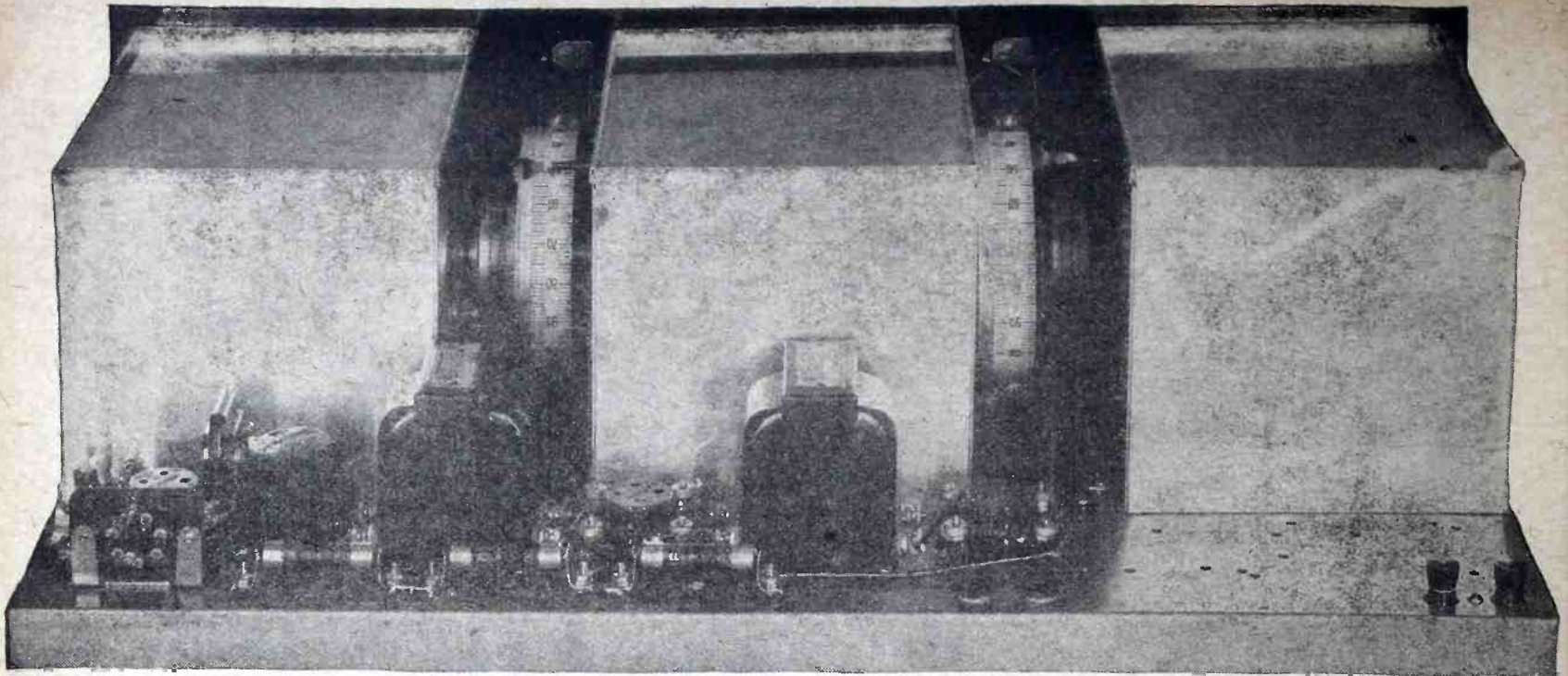
struction of a practically perfect audio amplifying system. If a power tube is used in the last stage of such an amplifier and its output fed into one of the better type speakers, the audio amplifying and reproducing system leaves little to be desired. However, this system can only amplify and reproduce what is fed into it by the detector tube, which in turn receives the signal from the radio-frequency amplifier. Hence it is evident that even a perfect audio system cannot provide a high-quality output from the loud speaker, if distortion is introduced in the R.F. amplifier due, let us say, to excessively sharp tuning, technically known

as "side band cutting." This illustrates the conflict between the two desirable characteristics, quality and selectivity.

Also the attainment of a high degree of radio-frequency amplification (sensitivity) is a distinct asset, if it can be attained without instability (tendency toward self-oscillation of one or more tubes) which impairs the quality of reproduction. High amplification is desirable because it enables the set owner to receive programs from very distant stations when he feels so inclined, and also because it makes possible quite satisfactory reception from local and moderately distant stations on a small indoor antenna even



This photo shows how the set appears when completed. Note the arrangement of parts within the shield compartments.



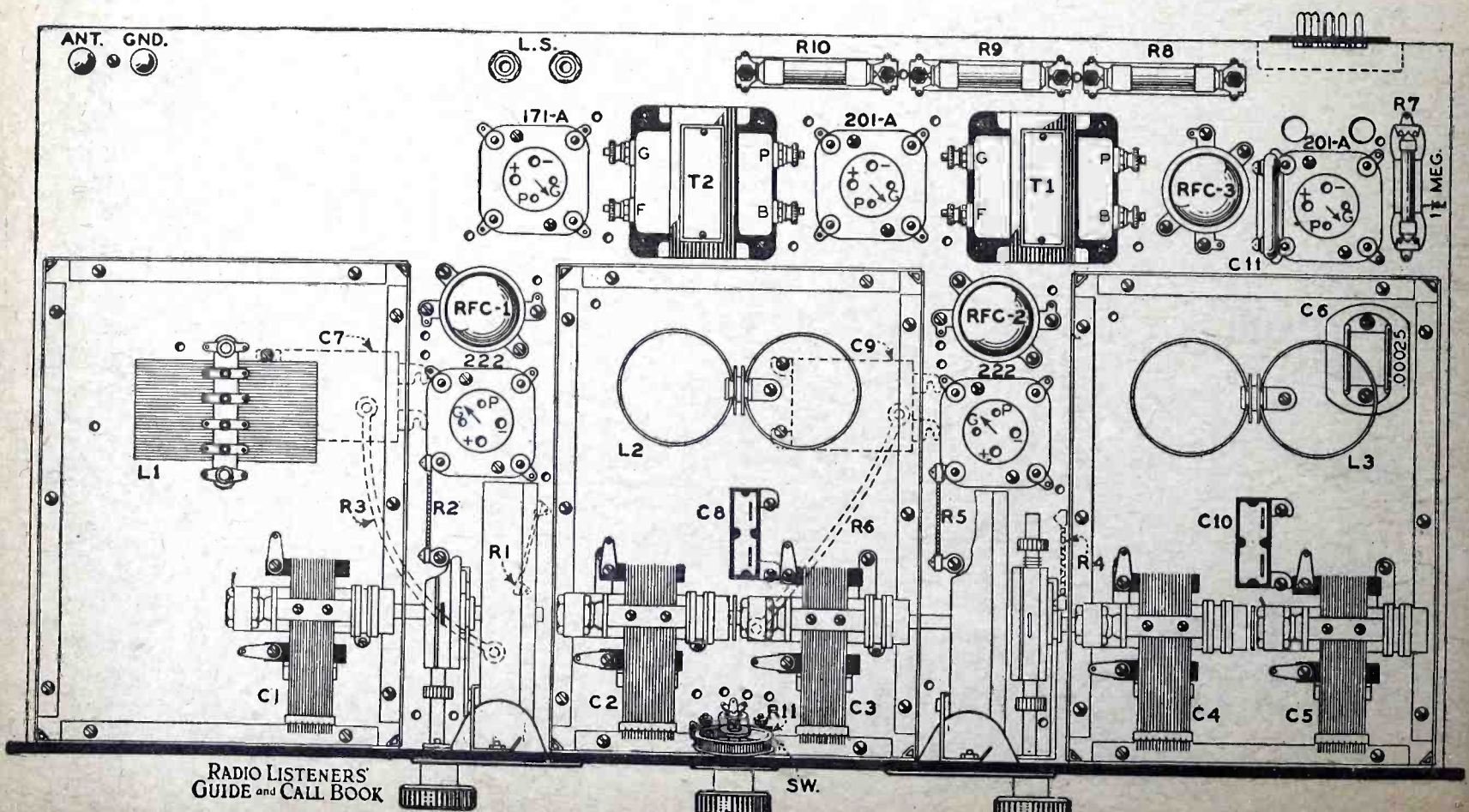
Rear view photo of the set with the shield covers in place on the compartments.

in unfavorable locations. However, selectivity and sensitivity are also incompatible. One of the reasons for this condition is not generally understood, and is even more seldom taken into consideration. The average receiver owner or experimenter bases his judgment almost entirely on the "apparent" selectivity. This is quite natural in view of the fact that the actual selectivity of a receiver can only be determined by a series of very careful measurements. The apparent selectivity of the ordinary radio set decreases as its sensitivity increases. Therefore, of two receivers having exactly similar "actual" selectivity and one having say three times the sensitivity of the other, the set having the higher sensitivity (or amplification) will invariably seem broader or less selective.

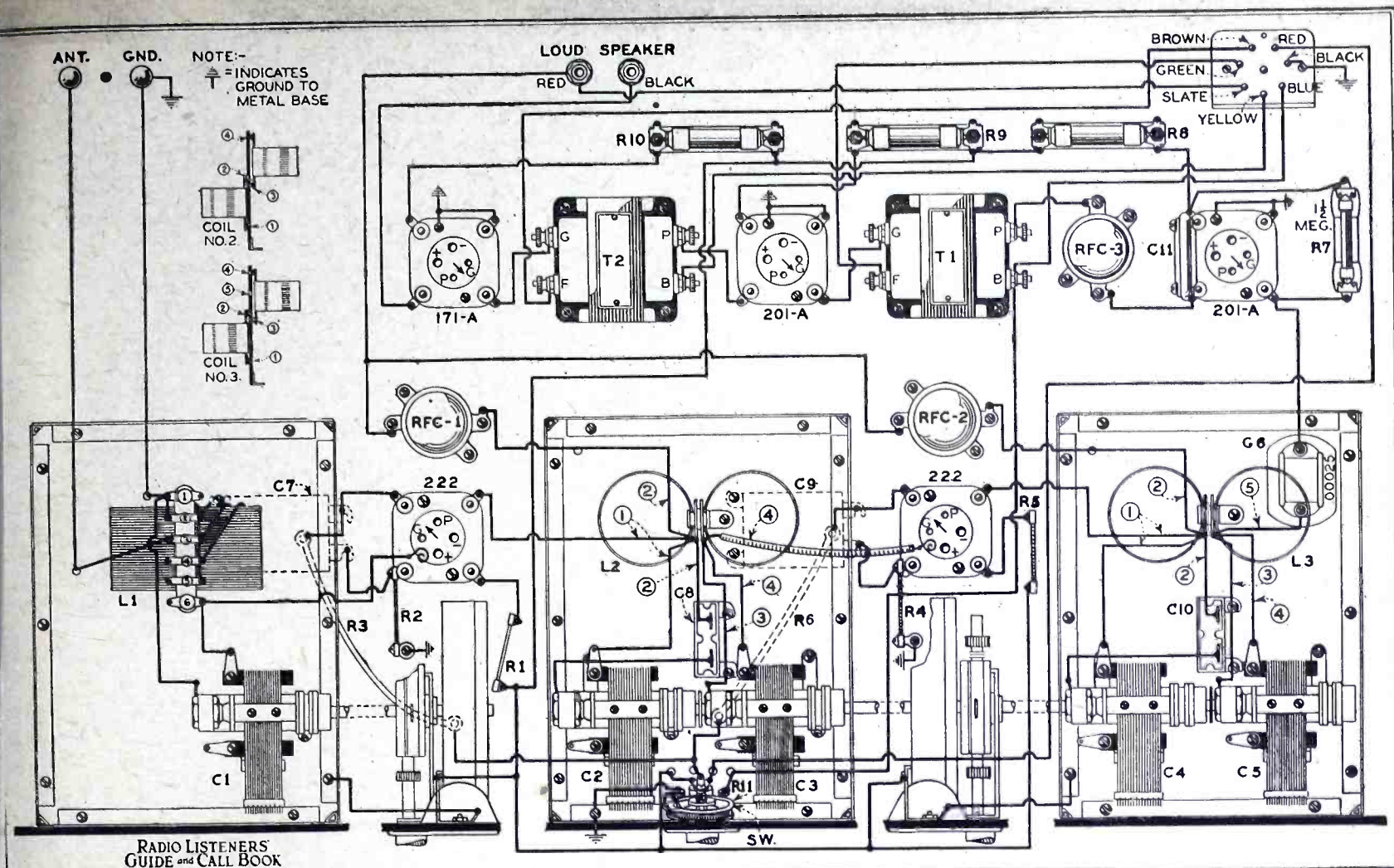
The enormous amplification and extremely low plate-to-grid capacity of the new screen-grid tube would at first glance seem to be ideal for use as radio-frequency amplifiers. The manufacturers of these tubes state that a voltage set-up of forty or more per stage is obtainable at broadcast frequencies. In addition the plate-to-grid capacity is said to be of the order of one-fortieth of one mmfd. or about one four-hundredth as great as that between the plate and grid of the 201-A type tube. Since it is this plate-to-grid capacity of the ordinary tube that is so troublesome in the design and construction of multistage radio-frequency amplifiers many schemes have been devised to neutralize this capacity in one way or another. None of these schemes has been entirely successful, however. Therefore,

the appearance of the screen-grid tube with a capacity so small that neutralization is unnecessary was welcomed by set designers, and many circuits using them made their appearance. Many of these sets did have enormous amplification, making possible quite satisfactory reception on short antennas. The selectivity of these sets, however, left much to be desired, so much in fact that the tube acquired the reputation of causing broad tuning.

The natural advantages of the screen-grid tube were carefully considered, also various methods of overcoming the apparent disadvantages were investigated. Two stages of radio-frequency amplification were decided upon as sufficient, as they could reasonably be expected to produce an overall voltage gain of over one



A layout of the parts is shown above. Carefully note the location of each component.



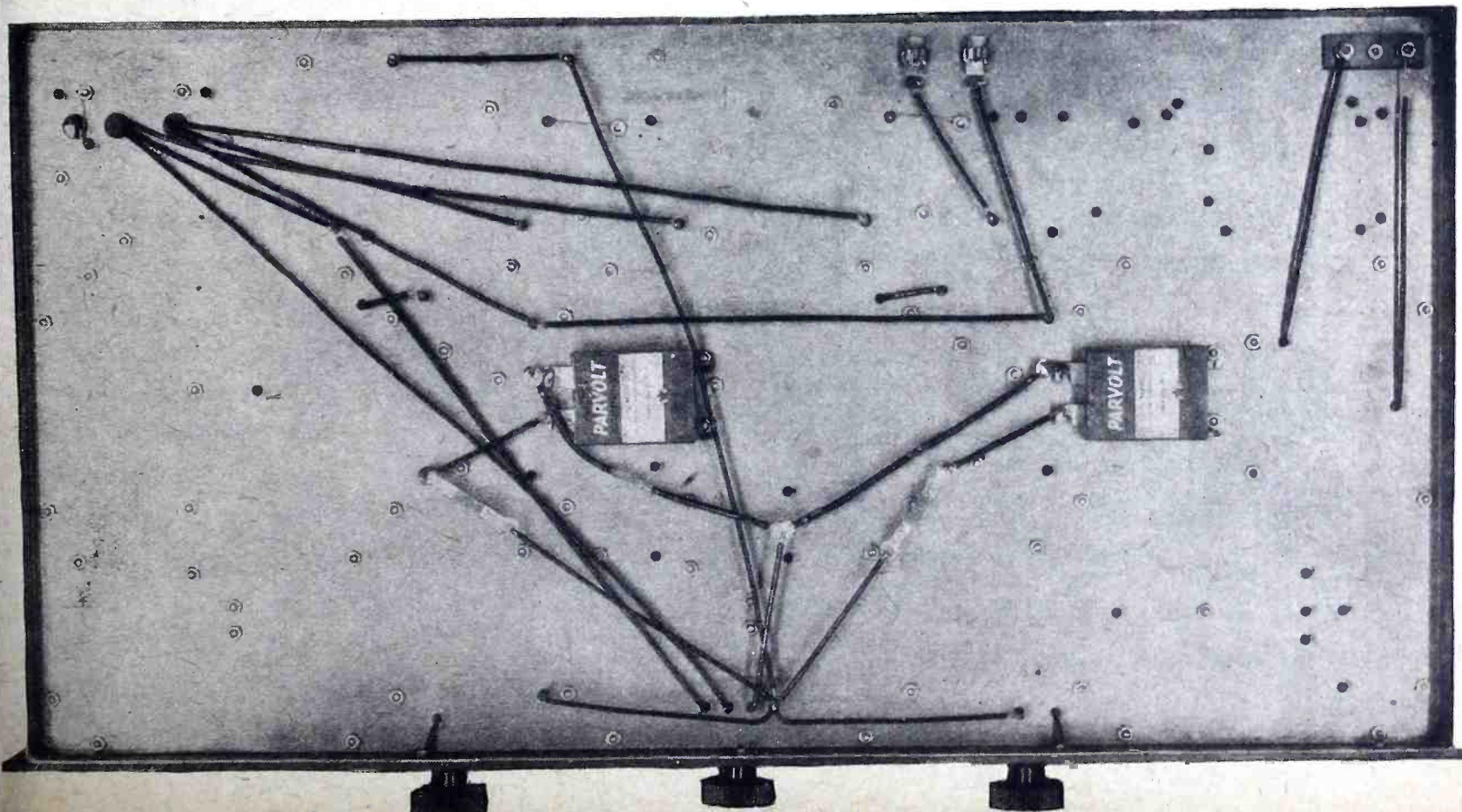
Picture wiring diagram of the receiver. Note the connections to coils as illustrated in the sketch at the upper left.

housand. In order to achieve a high degree of selectivity with this amount of amplification some special form of tuning is necessary. The conventional antenna coupler and two interstage tuned-radio-frequency transformers were found to be wholly inadequate in the matter of selectivity although the amplification was good. The tuned-plate impedance, coupling condenser and grid leak arrangement

specified by the manufacturers of the tube was passed up for the same reason. Calculation showed that it was quite feasible to tune both the grid and the plate circuits of these screen-grid tubes. This is one of the marked advantages of this type of tube, since an attempt to tune both the grid and plate circuits of an ordinary amplifier tube invariably results in uncontrollable oscillation.

When both grid and plate circuits are tuned, a two stage radio-frequency amplifier has a total of five tuned circuits including the grid circuit of the first tube. This increased number of tuned circuits would naturally provide a marked increase in selectivity.

The radio-frequency gain in an experimental set was very high; enough to bring  
(Continued on page 130)

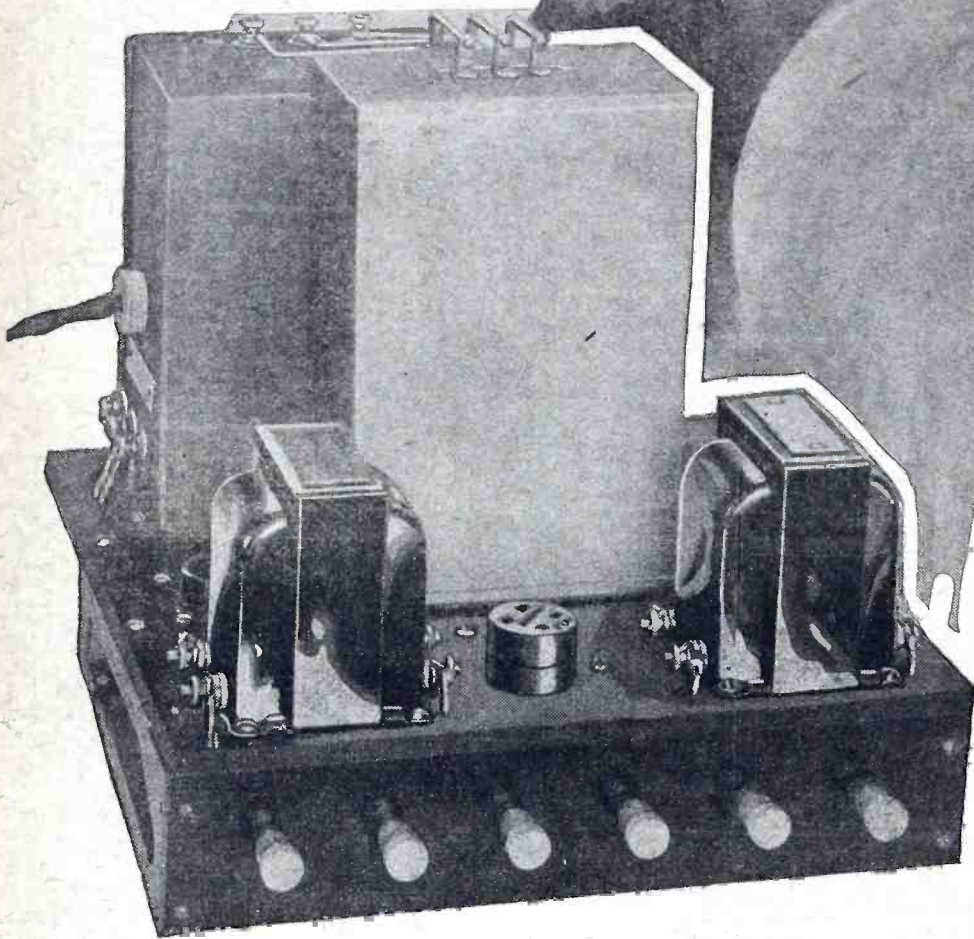


A view of the set from beneath the metal sub-panel, showing the wiring and two by-pass condensers.

# The THORDARSON

## TWO-STAGE PHONOGRAPH

### AMPLIFIER



of the phonograph, which is to be found in almost every home, to modern loud speakers.

#### LIST OF PARTS

- 1 Thordarson R-210 power compact, PC
- 2 Thordarson R-300 audio transformers, T1, T2
- 1 Tobe 210 condenser block, CB
- 1 Electrad fixed resistor, 5,000 ohms, type B, R2
- 1 Yaxley 400 ohm potentiometer, R1
- 3 Benjamin sub-panel sockets
- 6 X-L binding posts, 2 input, 2 speaker, 1 pos., 1 neg.
- 3 Benjamin sub-panel brackets
- 1 piece of bakelite 10x10x $\frac{1}{4}$ "
- 1 piece of bakelite 10x2x $\frac{3}{16}$ "

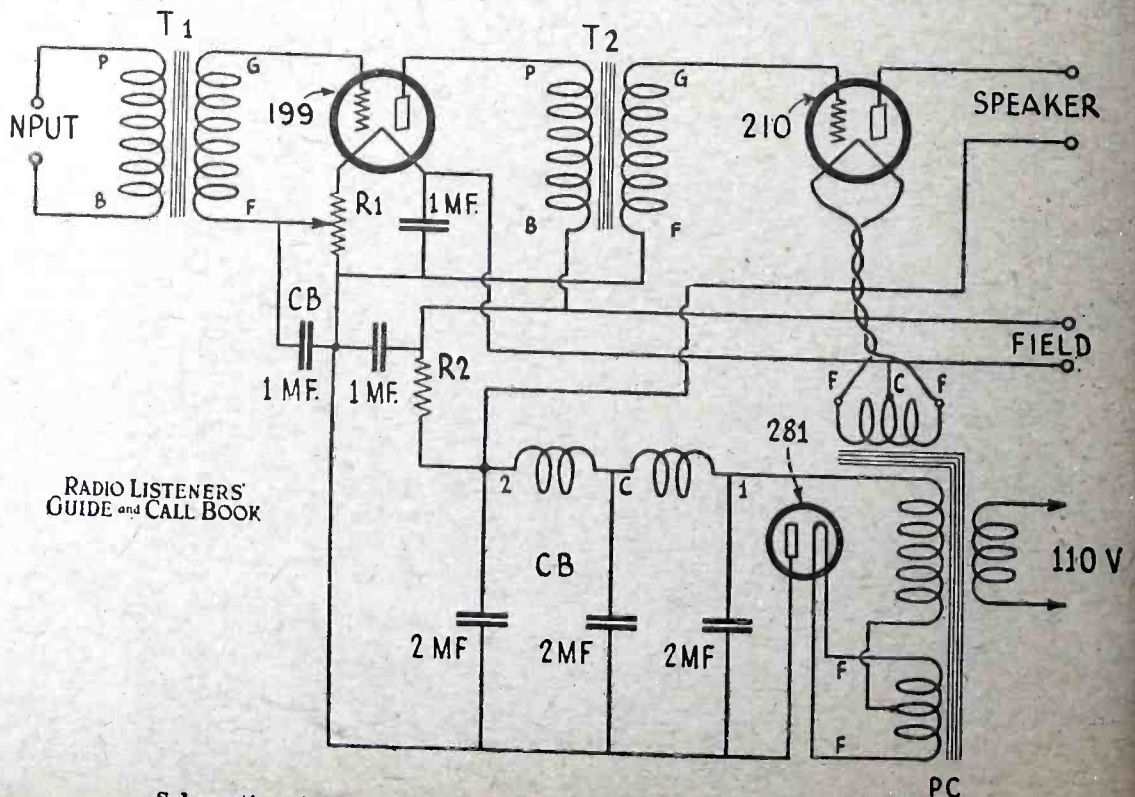
**M**ODERN trend in construction of radio receivers shows a decided tendency to incorporate a phonograph turn table into the receiver cabinet in order that, as is often the case, when broadcast programs are unsatisfactory either because of disliked programs or unpleasant atmospheric disturbances, one may entertain himself with phonograph music unmarred by ear splitting crashes or squeaky sopranos.

It has been predicted, not so much recently as earlier in the existence of popular radio, that the art of radio transmission and reception would render the phonograph obsolete. We have seen that such is not to be the case. Each fills its respective field and now we see a very desirable combination of the two. Radio is greatly responsible for the very marked improvement in phonograph reproduction and this very fact shows a kindred service that is well satisfied by the combination of the phonograph and the radio receiver into the same housing so that entertainment from either may be had at will.

The growth of radio has been rapid in the extreme with the result that the majority of homes into which the radio set has found its way cannot boast of equipment of the ultra modern type. In this

respect, parts manufacturers and radio publications have been endeavoring to help modernize apparatus which may be somewhat antiquated. One very large field of this endeavor is the adaptation

For the reproduction of phonograph music that approaches perfection, it is not at all necessary that expensive equip-



Schematic wiring diagram of the amplifier described in this article.

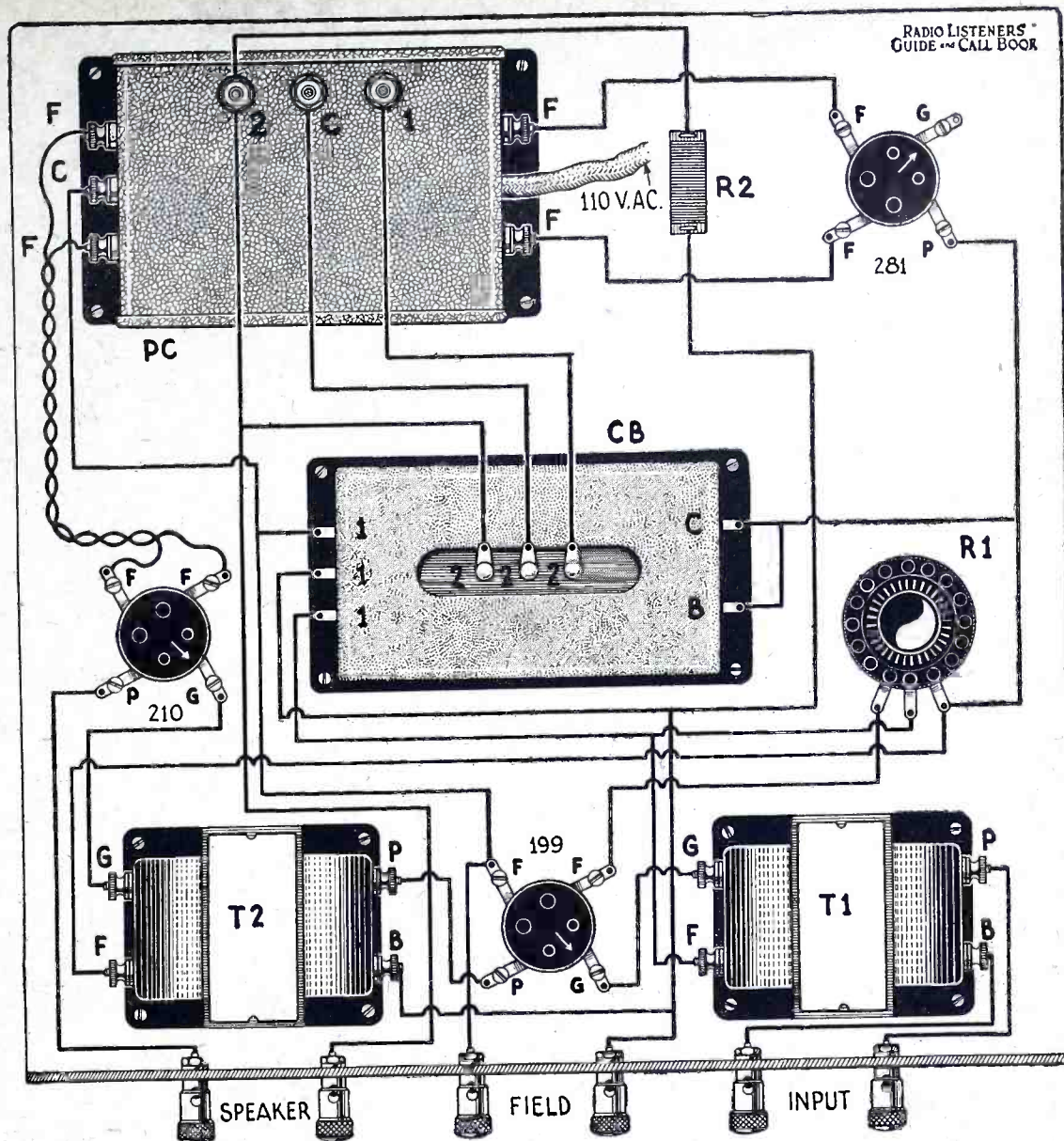


ment be used. With electrically recorded records at hand, any kind of a turn table, good phonograph pickup, a good power amplifier working into a loud speaker that is capable of faithful reproduction of the audio frequencies, a result is had which is decidedly pleasing and which need not be apologized for when compared with any form of auditory enjoyment.

It is more often than not, however, that it is difficult to place the phonograph and the radio receiver sufficiently close together that inter-connection may conveniently be made between the electrical pick-up unit operating on the turn table and the audio frequency amplifier. As a matter of fact, there are times when the distance between these two instruments is necessarily so great that connections could be made only with difficulty and when the enjoyment of such a combination would be seriously impaired by the inconvenience of attending to the phonograph.

It was because of the appreciation of these difficulties that this very small, compact, inexpensive amplifier was designed. Because of its adaptability it makes possible the rich tonality of electrical phonograph reproduction with a minimum of cost and inconvenience.

The amplifier is operated completely from alternating current and is so constructed that it is readily portable. It is exceedingly compact and may be placed in one of the compartments or in the tone chamber of the phonograph so that no unsightly or difficult connections to the radio receiver are necessary. It need



Picture diagram of the two-stage radio and phonograph amplifier.

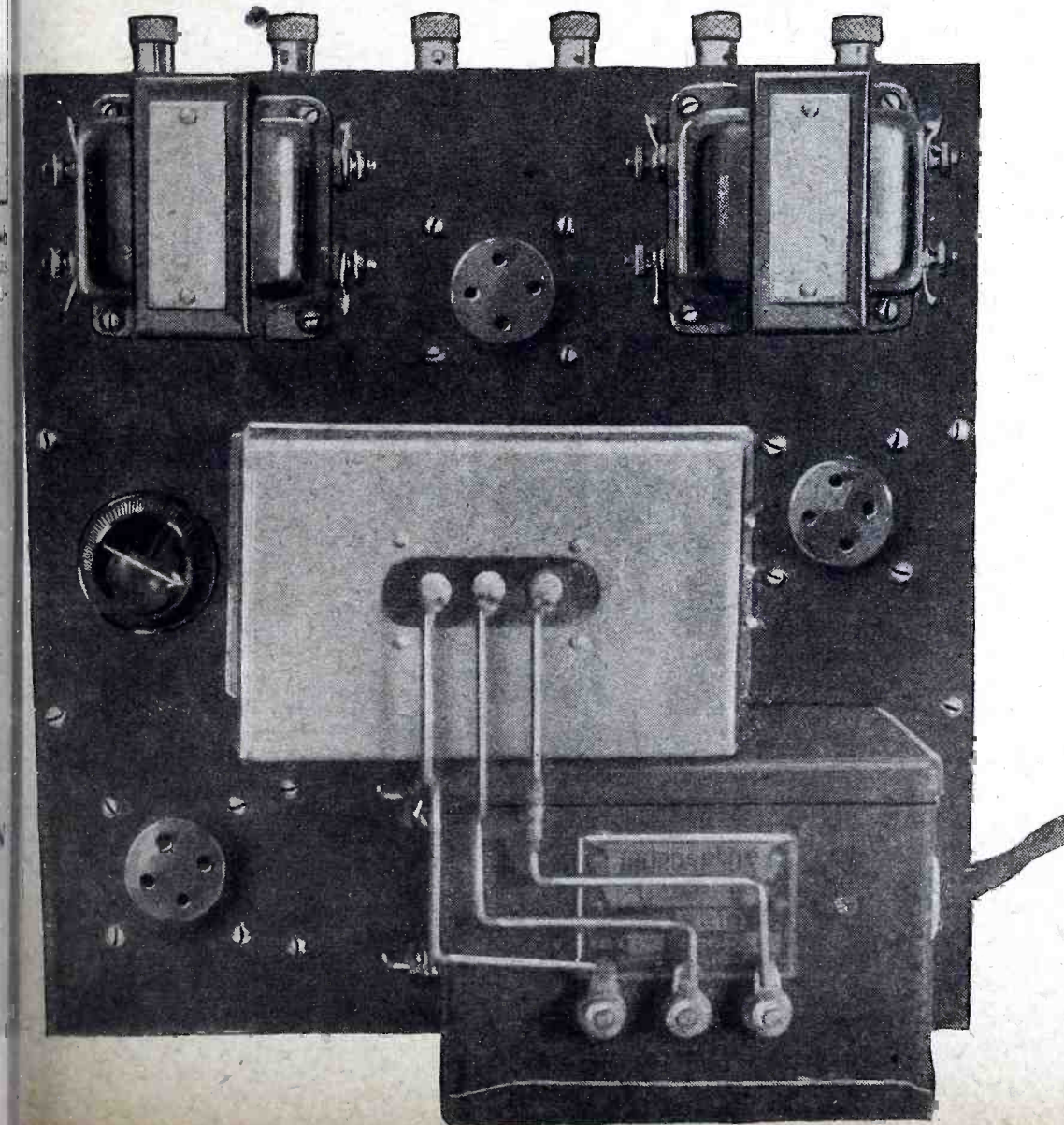
only be connected to a dynamic speaker (power for the field of which is provided in the amplifier), to the phonograph pick-up, and the alternating current source to be ready for the phonograph amplification. The result is phonograph reproduction that indeed leaves little to be desired.

The leads from the electric phonograph pick-up are connected to the two terminals marked "Input." It may be desirable in cases where the pick-up is not provided with a volume control to incorporate a variable resistance of about 200,000 ohms across the terminals of the pick-up to perform this function. By adjusting this resistance, then, any desired volume may be obtained.

In order to fulfill the requirements for compactness with no sacrifice of efficiency, a very unique combination of apparatus is employed. The power transformers and filter chokes are completely housed in the power compact. This unit furnishes power for the high voltage supply to the plate of the 281 rectifier tube, power for the filament of the same tube, as well as power for the filament of the 210 power tube. The rectifier and filter circuits are conventional, and furnish, to the voltage divider, direct current free from bothersome hum.

It will be noticed, however, that the voltage divider is not conventional, in that filament current for the first audio frequency tube is supplied by the current flowing through the divider. In other words, the filament of the

(Continued on page 141)



A top view of the unit showing layout of parts. Most of the wiring is beneath the base.

# The Braxton-King Shield Grid Short Wave Set

THE Braxton-King Shield Grid Short Wave Receiver is of a new design, incorporating several new and unusual features. It is a single control receiver, employing one stage of untuned RF amplification, regenerative detector and three stages of resistance coupled audio frequency amplification. The resistance coupled audio is optional, and, if desired, the receiver may be constructed to use standard audio transformers, or constructed as a short wave adapter, to



effects upon the operation of the receiver. First, it makes the receiver much more stable in operation; second, it prevents the detector tube from radiating energy into the aerial. Third, it makes it possible to calibrate the single tuning dial of set; fourth, the dead spots (points on the tuning dial where the set cannot be

ing control, but it does provide an appreciable gain in amplification, due to the fact that this tube is used. The addition of the RF stage has many other desirable

made to oscillate because of aerial characteristics) of the set, are eliminated by virtue of the fact that the aerial is not connected to the detector circuit of the set.

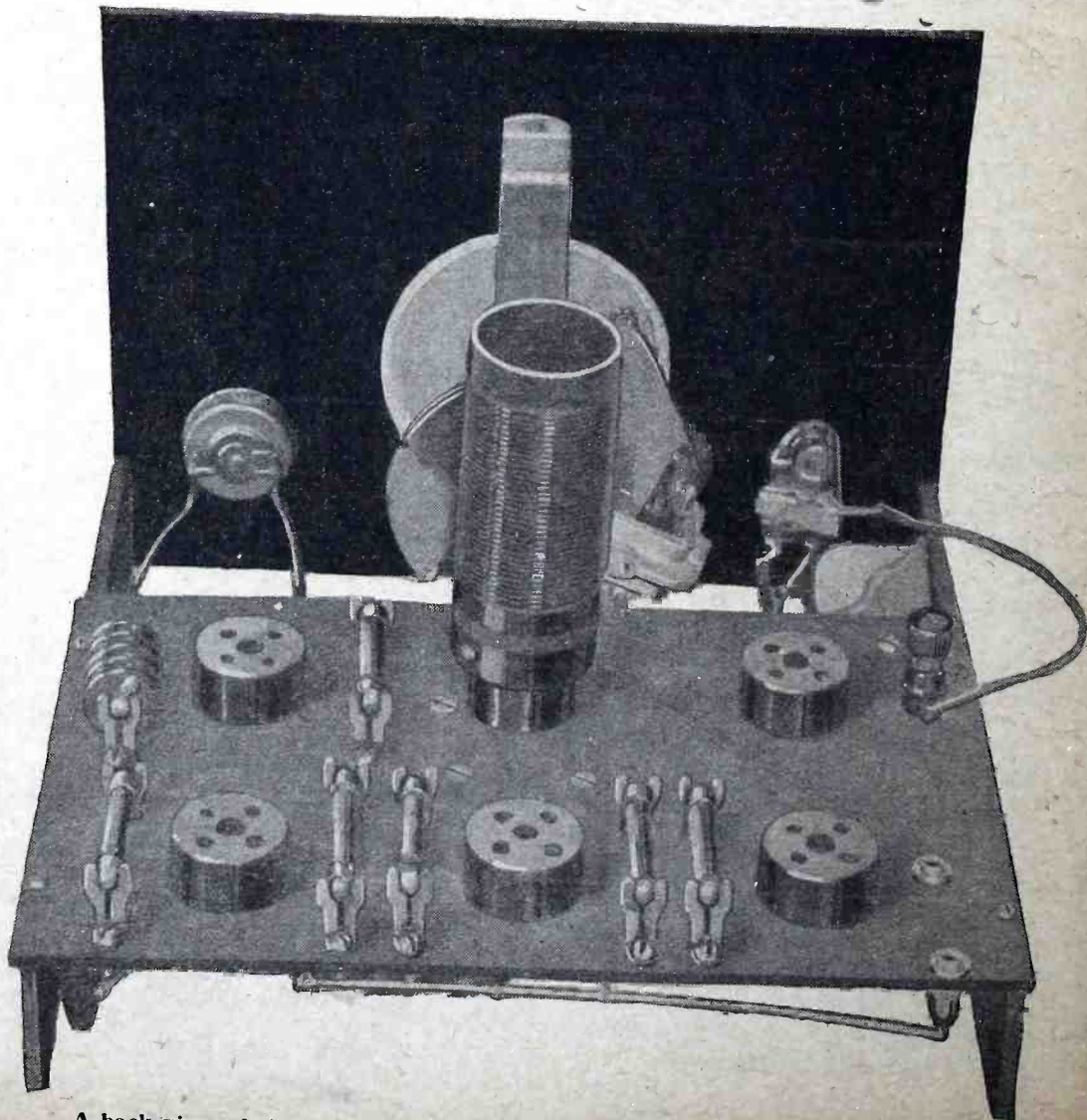
## LIST OF PARTS

- 4 Braxton-King plug-in short wave coils, L2
- 1 Braxton-King R.F. choke, L3
- 1 Braxton-King antenna impedance, L1
- 1 Braxton-King foundation unit
- 1 National vernier dial
- 1 Hammarlund Midline .00015 mfd. variable condenser, C1
- 1 Clarostat, 0 to 500,000 ohms, R4
- 1 Yaxley battery switch, SW
- 2 Tobe .5 mfd. by-pass condenser, C8, C9
- 1 Aerovox fixed condenser, .001, C2
- 1 Aerovox .002 mfd. fixed condenser, C4
- 1 Aerovox .00025 mfd. fixed condenser, C3
- 2 Yaxley phone tip jacks
- 1 Corwico five wire cable
- 1 Durham 3 meg. grid leak, R2
- 2 Durham 1/10 meg. grid leak, R6, R8
- 1 Durham 1/4 meg. grid leak, R9
- 1 Durham 1/2 meg. grid leak, R7
- 1 Durham 1 meg. grid leak, R5
- 1 X-L antenna binding post
- 1 Roll Corwico Braidite hook-up wire.

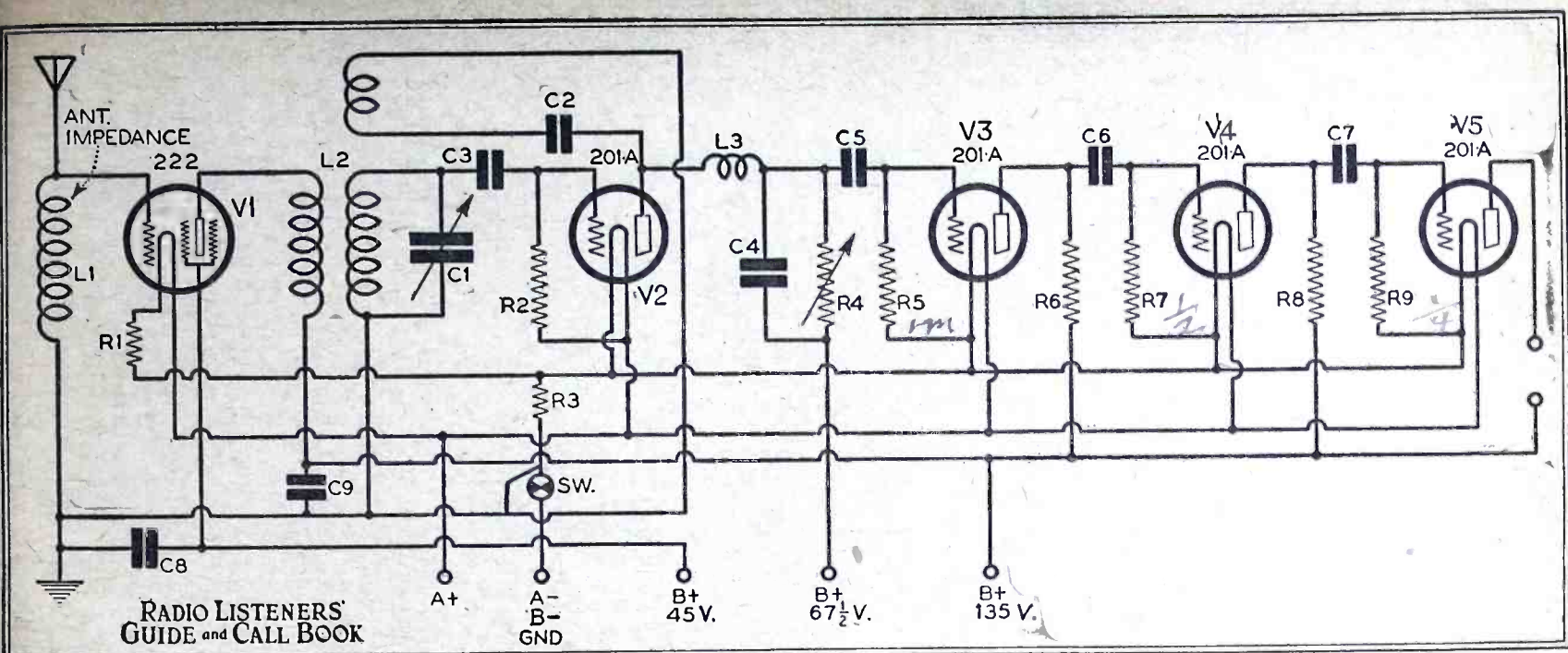
be used in connection with any broadcast receiver.

A shield grid tube is used in the untuned RF stage, so that a step-up amplification of three to four is impressed on the signal before it reaches the regenerative detector.

The shield grid RF amplifier, being of the untuned type, does not add a tun-



A back view of the set showing how the parts are mounted. The coil in the center is interchangeable.

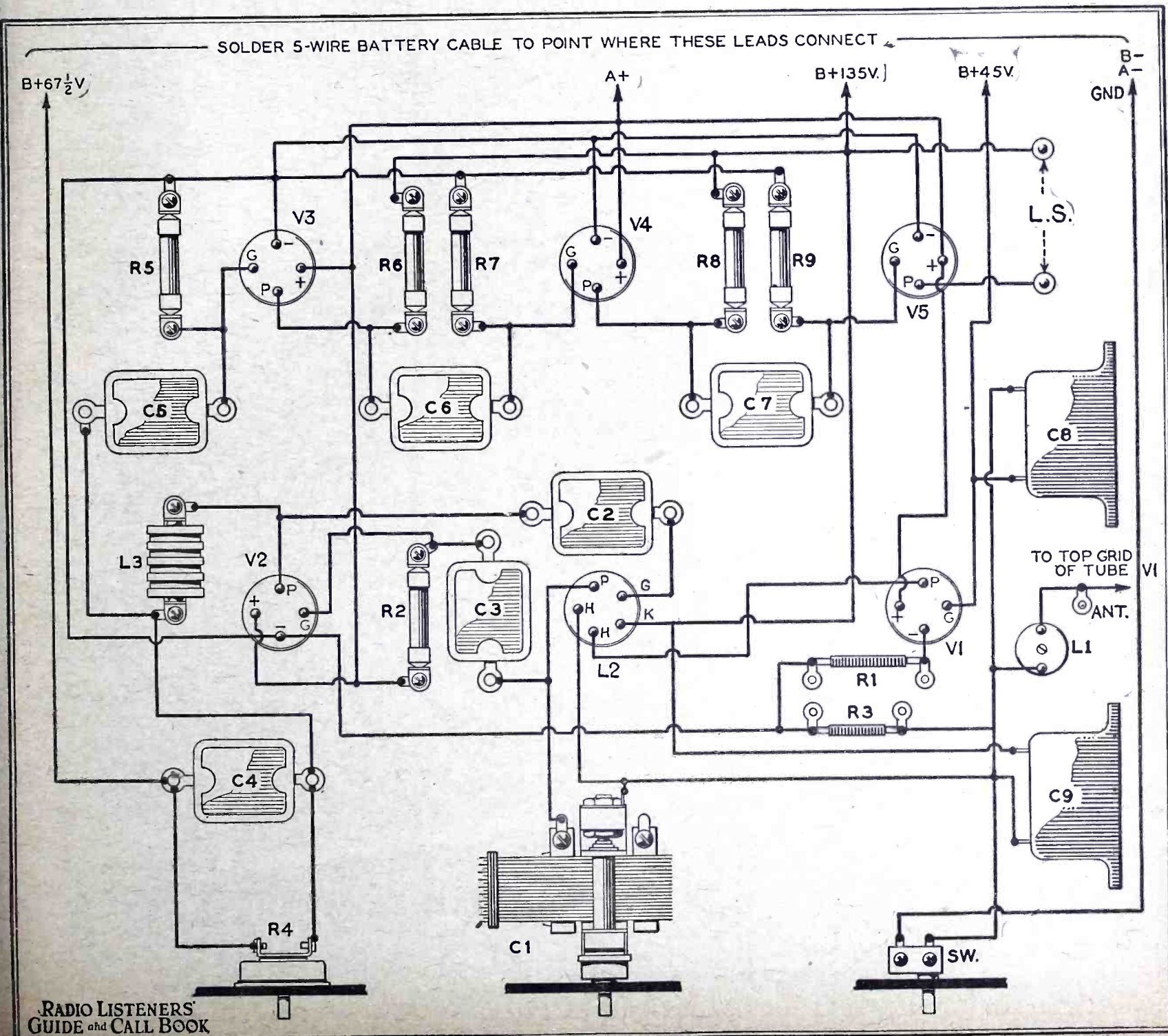


Schematic diagram of the set. All parts are indicated by symbols corresponding to those in the list of parts.

Four plug-in interchangeable short wave coils are used, and these will cover the band of 15 to 120 meters. These coils are all accurately wound on threaded

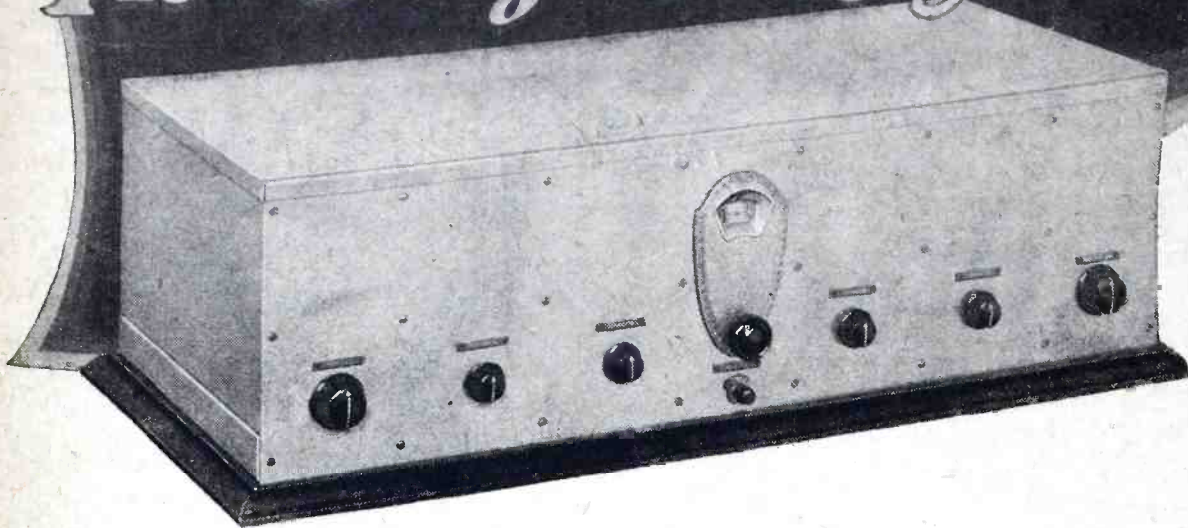
bakelite tubing, the secondary being space wound with No. 19 enameled wire with the primary also space wound with No. 30 double silk-covered wire. The ratio of

these two windings is one to one, which is the most efficient coupling for use with the screen grid tube. The tickler winding (Continued on page 112)



Picture wiring diagram of the short wave receiver employing resistance coupled audio amplification.

# The Sargent-Rayment Seven



**O**RIGINATING on the Pacific Coast, where distance reception in the principal cities is beset with even greater difficulties in many respects than in New York or Chicago the Sargent-Rayment Seven has had the distinction of being very widely acclaimed in these localities as the first tuned-radio-frequency design capable of going through the wall of local interference. When it is realized that, unlike most of the stunt selectivity sets even of the present day, the Sargent-Rayment is a one dial job, and that the cost of the complete kit of parts is far less than that of others with which it might be compared, it is not difficult to explain the general enthusiasm which has in recent weeks centered around this unique receiver.

We have said that the Sargent-Rayment tunes with one dial. This is true in the sense that the tuning dial operates all five of the major tuning condensers. There is, however, a separate vernier condenser or "trimmer" provided for each one of the five tuned circuits. It has been felt by the designers that any set intended for the use of veteran, "sophisticated" fans, who demand the last word in distance reception, must be provided with some means of testing and adjusting all the tuned circuits to absolute resonance at such times as the full sensitivity and sharpness of the receiver are required. In the Sargent-Rayment, where real convenience as well as top-notch results have been aimed at, these verniers are all controlled by individual knobs on the front panel. The mounting of the verniers to give full accessibility is not, however, to be taken as indicating any deficiency in the one-dial tuning action; for all ordinary purposes—that is say, for the reception of stations whose signals are far enough above the noise level to make them ordinarily useful or pleasurable—the five vernier knobs can be entirely disregarded after once setting them in proper position. In this way, the Sargent-Rayment provides all the usefulness of two receivers in one: a one-dial set with first class tone quality for use as a musical instrument and—with the use of the vernier knobs—a job with which the experienced "ether prowler" can ex-

plure the very depths of weak signals, hardly distinguishable from atmospheric noise.

## LIST OF PARTS

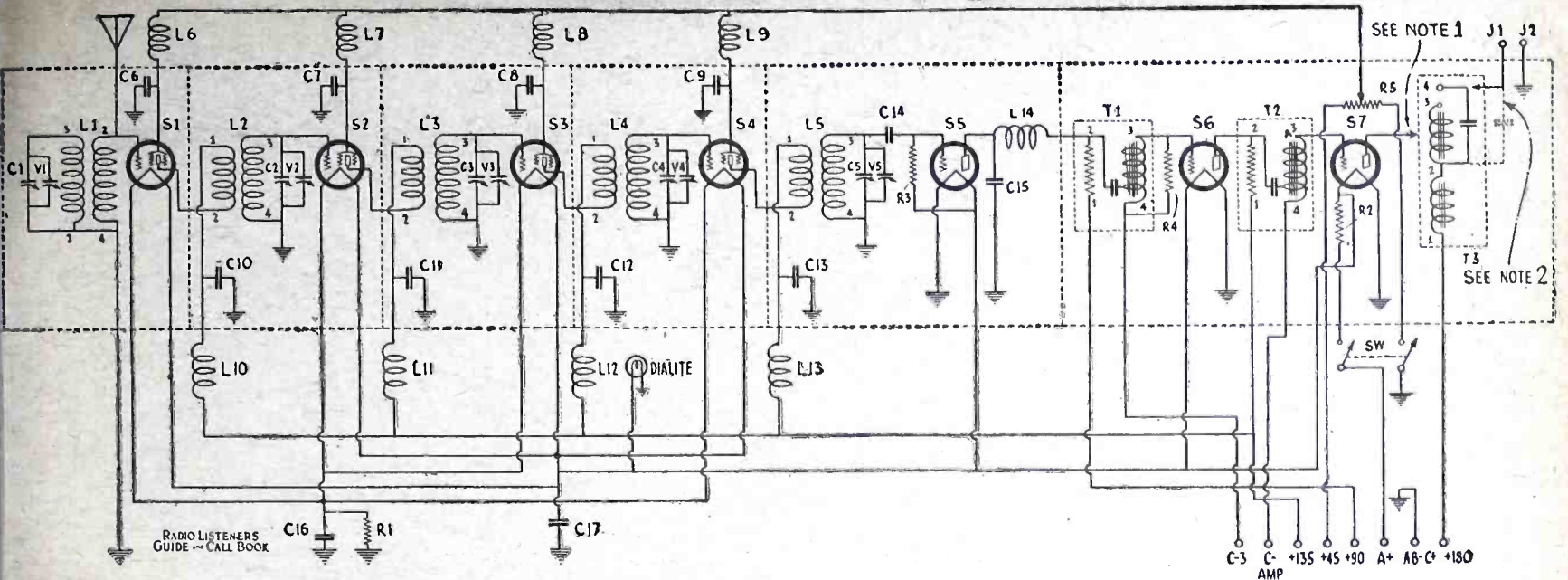
- 1 S-M 705 aluminum shielding cabinet, SH
- 1 S-M 141 antenna coil, L1
- 4 S-M 142 RF. transformer coils, L2, L3, L4, L5
- 5 S-M 32OR variable condensers, .00035 mfd., C1, C2, C3, C4, C5
- 5 S-M 340 midget condensers, .000025 mfd., V1, V2, V3, V4, V5
- 9 S-M 275 RF. chokes, L6, L7, L8, L9, L10, L11, L12, L13, L14
- 7 S-M 511 tube sockets, S1, S2, S3, S4, S5, S6, S7
- 1 S-M 255 first stage AF transformer, T1
- 1 S-M 256 second stage AF. transformer, T2
- 1 S-M 251 output transformer, T3
- 1 S-M 708 ten-lead battery cable, W
- 1 National type "F" velvet vernier dial with illuminator, D
- 8 Polymet  $\frac{1}{4}$  mfd. condensers, C6, C7, C8, C9, C10, C11, C12, C13
- 1 Polymet .00015 mfd. condenser, C14
- 1 Polymet .002 mfd. condenser, C15
- 1 Polymet grid leak mount
- 1 Polymet 2 megohm grid leak, R3
- 2 Polymet 1 mfd. by-pass condensers, C16, C17
- 2 Yaxley 420 insulated tip-jacks, J1, J2
- 1 Yaxley 53,000P (3,000 ohms) potentiometer, with  $1\frac{1}{2}$ " knob, R5
- 1 Yaxley 740 Junior switch, double circuit (DPST), SW
- 1 Durham 150,000 ohm resistor with leads (optional), R4
- 3 Hammarlund flexible shaft couplings
- 1 Carter H1, 1 ohm resistor, R2
- 1 Carter H3 resistor (3 ohms), R1
- 2 X-L binding posts, BP1, BP2
- 50 ft. S-M 818 hook-up wire
- 1 S-M 706 walnut base moulding
- 1 set assembly hardware, etc.

In size and amount of wiring, the Sargent-Rayment Seven is not very different from various manufactured receivers now available in the higher price class. It is interesting, though, to compare, by actual figures, the relative r.f. effectiveness of a design like the Sargent-Rayment and of

common types of manufactured receivers. A fair average figure for six-tube sets in common use is 1,000; that is, the signal reaching an antenna is amplified about 1,000 times before detection. The r.f. gain of the Sargent-Rayment, operating in a perfectly stable manner, is on the order of 83,000 times at 550 kc. (the frequency of lowest gain).

This amount of radio frequency amplification, while very high as compared with ordinary receivers, is not to be thought of as the highest that can be obtained with four screen-grid tubes—far from it, in fact. It is rather the amount of r.f. amplification which was found, in a series of extensive tests, to be sufficient—with the nearly ideal coils employed and with such thorough shielding as is here used—to go down to the lowest noise level. This leaves, then, a very considerable margin of unused amplification possibilities in the screen-grid stages, which has been carefully converted, in the design of the coils, to the improvement of *selectivity*—and this is to a large extent the secret of the straight-sided tuning peak so characteristic of the Sargent-Rayment's performance. Another important factor is the wave filter, of the so-called rejector type, which is built into the antenna circuit.

In the measurement of selectivity, a fair indication of the effectiveness of any tuned-radio-frequency stage is the ratio of amplification of a signal at the peak of the tuning curve, to the amplification of a signal on the next channel to it (10 kilocycles different in frequency). A general average figure for ordinary receivers is not so easy to strike here; a ratio of 5.3 for each stage has been found in the Sargent-Rayment, or a total of 790 (that is, 5.34) for the four stages. Remembering how small an interval 10 kilocycles is, it will not be wondered at that this sharpness opens up every 10-kilocycle channel in the whole range, in every congested broadcasting district from which reports have been received. In particular, definite logs showing one or more stations received on every channel have been sent in from Los Angeles, as well as from New York. Reception of various Australian, New Zealand, and Japanese stations has been reported from a number of points in the United States. In view of the difficult receiving conditions which obtain in Pacific Coast cities—said to be due both to the unshielded power wiring so much used in this locality, and to the extensive use of wood construction in buildings—it is interesting, even for eastern dwellers, to consider at



Schematic wiring diagram of the Sargent-Rayment Seven. Refer to Note 1 and Note 2 in the picture diagram on the next page.

greater length some of the results obtained with the Sargent-Rayment out on "the Coast." In the heart of the city of Los Angeles, one of these sets was installed in a store, using a 10-foot antenna. The location was in the midst of the steel building district, two blocks from the transmitter of Station KPLA and five blocks from KFI. The owner of the store had never before been able to receive signals from Seattle—the distance being about 1,000 miles. With the Sargent-Rayment, Station KFOA, Seattle, was picked up without difficulty.

From Seattle, on the other hand, comes the following, written by Walter A. Reeves (amateur license W7KO) of 1440 Palm Avenue, in that city:

"I bought two Sargent-Rayment receivers, one a wired set for a friend and the kit for myself. I had to wait over two months for it but it was well worth waiting for.

"I already had an S-M 681 power pack which I cut in on the first audio stage.

Using an old (5-year-old) Rola horn, the quality is wonderful, and all our friends are very enthusiastic about it. With a good cone or dynamic it would surely be a knockout. It may interest you to know that the first station I tuned in was KOA—1,500 miles away—and that last Saturday morning from 3 to 4:30 A.M. we listened to 3 stations in Japan, JOAK, JOGK and JOHK, and to KOIA, which was apparently a Chinese station.

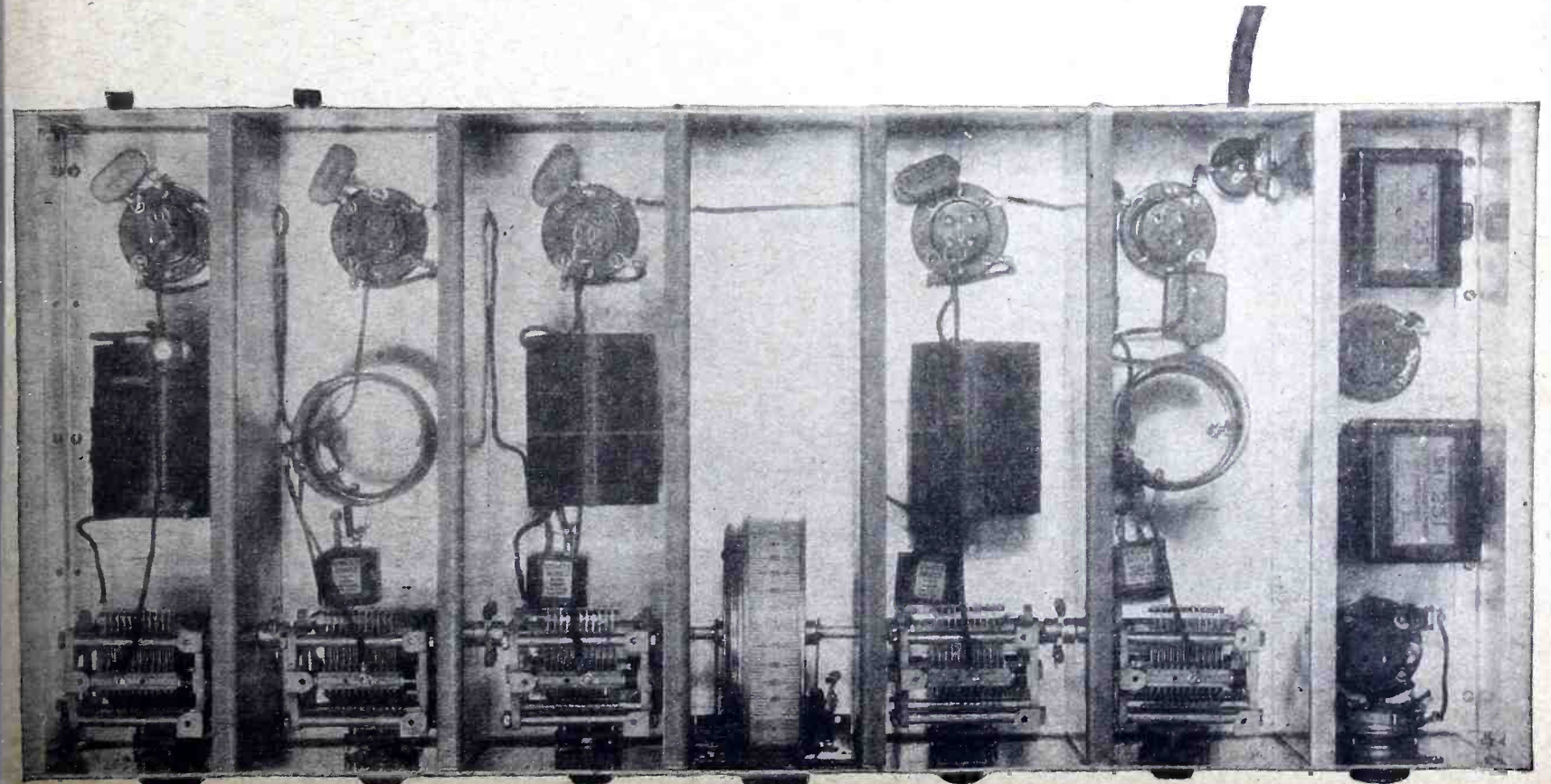
"We listened to JOAK for 30 minutes straight, with such volume that we were expecting to awaken our next door neighbors. The other two Japs were not nearly so strong, but perfectly understandable had they been speaking English. KOIA was also very strong, with volume about two-thirds on. Also had an Australian or New Zealander, but he was fading so bad that I couldn't log him."

While an interesting sidelight on daytime reception, in another section of the country, comes from Carl Riedel, of 425 Main St., Benwood, W. Va.:

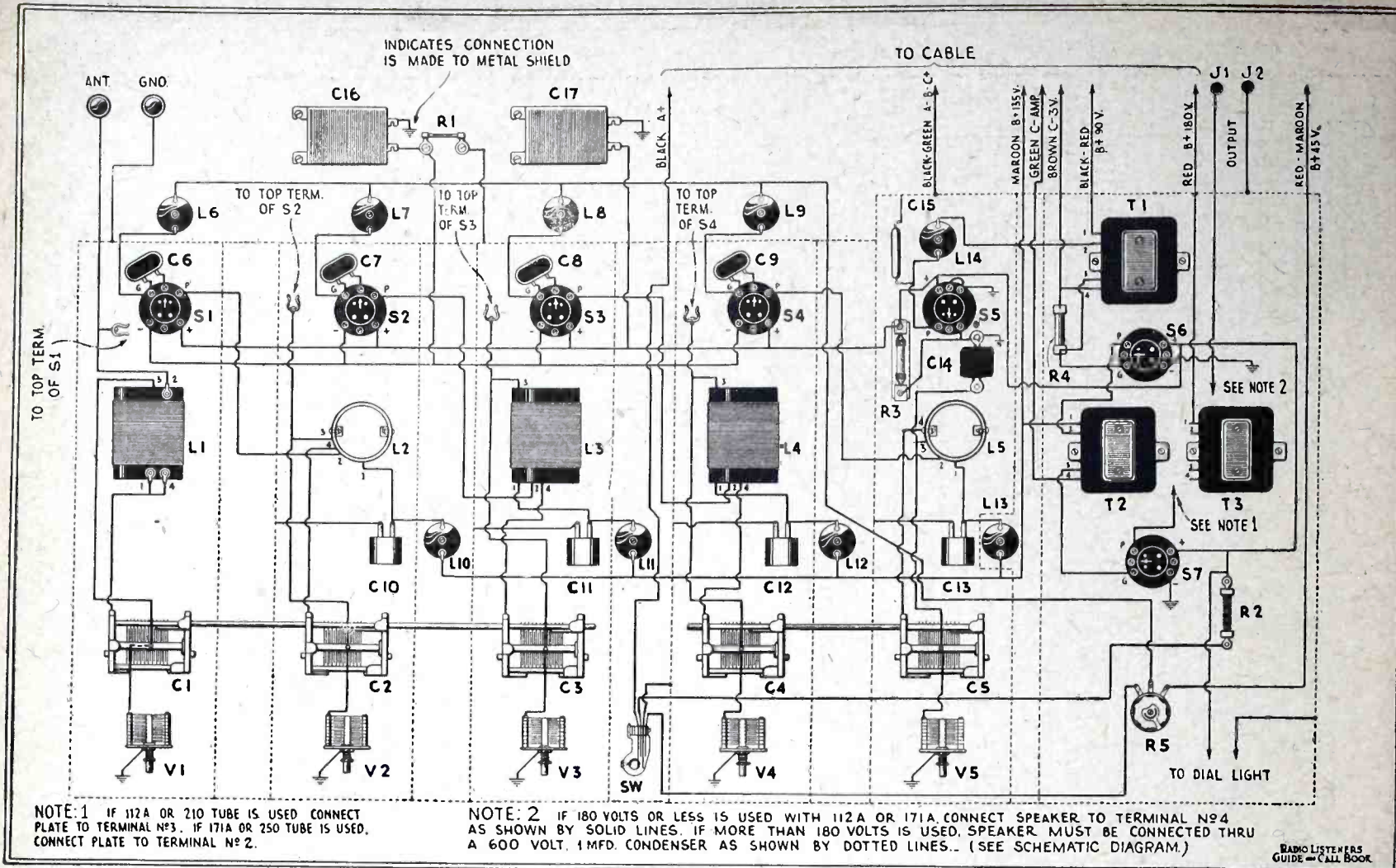
"It is one week today since I completed the assembly and wiring of my Sargent-Rayment Receiver, and I am beginning to understand why these kits are in such large demand, as I have had wonderful results so far. I am able to pick up Chicago and Canadian stations in the early afternoon, which is more than I could do with my "super-het" 8-tube, that I had been using; also I find it more selective.

"I believe I have had the usual luck, as I am unable to make the set motor-boat, regardless of detector voltage used, nor make it oscillate."

Reference has been made above to the fact that the Sargent-Rayment is capable of doing double duty—as a long distance receiver for veteran "dial twirlers," and as a musical instrument for ordinary home reception—owing to its convenient one-dial operation and its almost perfect tone reproduction. The latter quality, being somewhat unusual in sets designed for extra high selectivity, may be explained more in detail.



A top view of the receiver showing the shielded compartments and arrangement of parts.



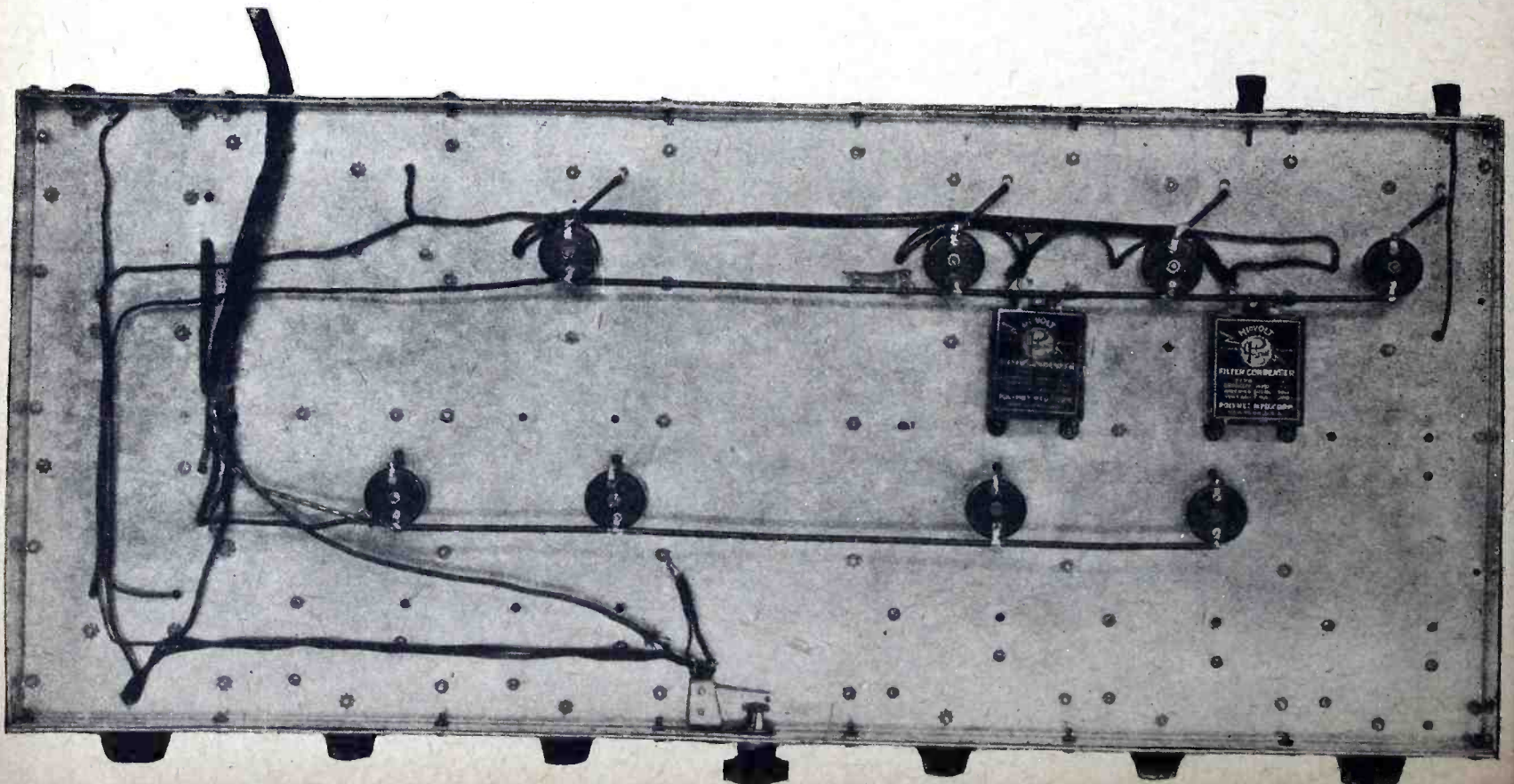
Picture wiring diagram of the set. All parts are marked to correspond with the schematic diagram and list of parts with this article.

Two audio stages are employed, the latter utilizing either a 171 or 250 type power tube. Transformer coupling is employed in both stages, but the transformers are not of the standard type; they are the special type of transformers which has become well-known under the name of their originator, Kendall Clough. The "Clough system" transformers utilize a resistance and a condenser, built integral with the transformer proper, which is

wound as an auto-transformer. Coupling instruments of this type not only avoid the common defect known as hysteretic distortion, but by means of built-in low-frequency resonance, they extend the range of uniform amplification well down into the bass ranges, to a degree which it is practically impossible to obtain with standard transformer construction. It is also to be noted that a considerably higher amplification ratio is employed with the

Clough system transformers, as manufactured by Silver-Marshall, Inc., than is offered in any of the strictly high-grade transformers of standard construction now available.

One peculiarity is observed by almost everyone who uses a Sargent-Raymont Seven. Instead of the ordinary experience of having to make a radically different adjustment of volume or sensitivity  
(Continued on page 128)



A bottom view of the set showing how the condensers and chokes are mounted and wired.

# The Halldorson A.C. 56 Receiver



**I**F the receiver shown in the accompanying diagrams and photos is wired with reasonable care the results obtained should be equal in every way to the models tested at our laboratory. The results possible are ample selectivity and sufficient volume for the operation of a dynamic speaker with exceptional tonal quality due to the push-pull amplifiers. The tone quality for home purposes should equal that obtained from a 250 power tube, and the distance equal to the same number of tubes when used in an efficient battery operated circuit. The fact that the receiver is A.C. does not reduce its distance getting ability. No hum should be heard even when the receiver is detuned from a station.

That A.C. tubes have been perfected, has been proven by every large set manufacturer. The public will have nothing but A.C. receivers. Eliminators for doing away with the storage battery no longer meet approval.

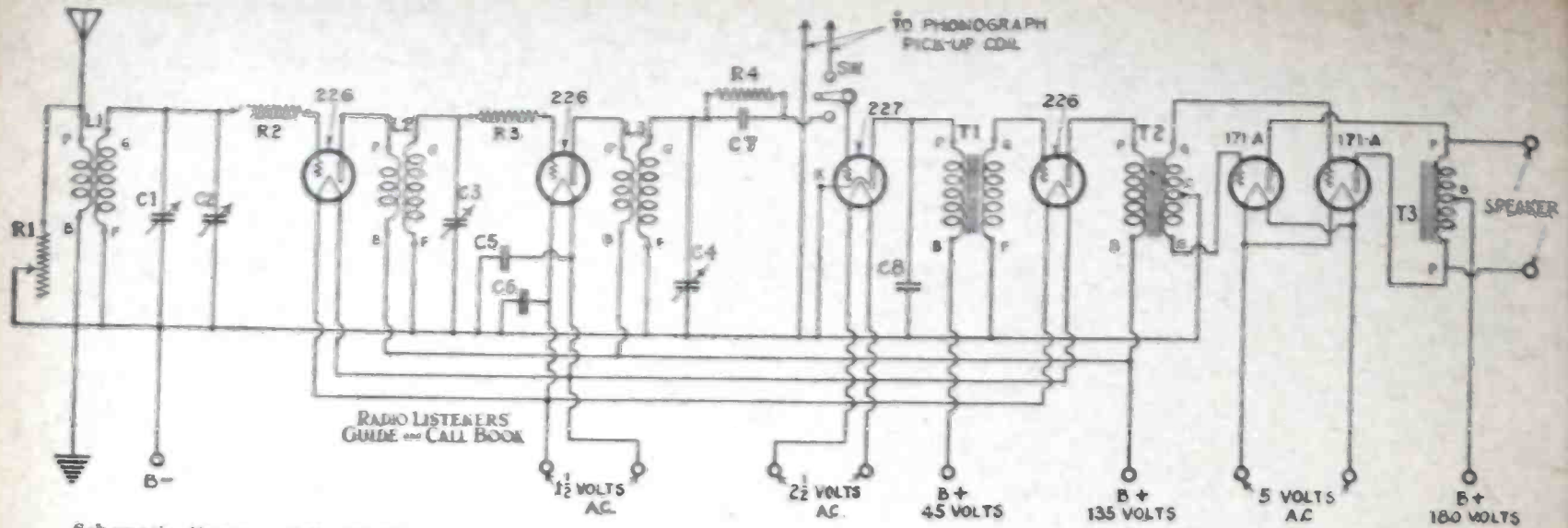
The first procedure upon obtaining your kit is to carefully check the parts with the list of parts shown below. This formality over and everything found perfect, the coils and audio transformers should be mounted upon the sub-base. The sub-base should be laid flat on the bench with its front edge to the builder, and in order that no mistakes should occur, it is wise to temporarily lay each part upon the sub-base where it is to be bolted down later. It will be found that there are three mounting holes on the front left hand corners of the sub-base that take care of the variable condenser unit. The stage shield bases and sockets being riveted in place at the factory require no attention. Proceeding to the right,

the transformers should next be put on the base. The audio transformer, which has four regular terminals, is mounted first from the rear in such a manner that the Halldorson name on the top of the transformer is backward. The next transformer in line is the push-pull input. This transformer is distinguished from the others by the fact that it has four terminals on the case and a fifth lead which is to go down through the sub-base. It will be found that the hole in the sub-base accurately matches the position of this lead. Care should be taken when handling the transformer not to tear the lead from the transformer. The name on this transformer should also appear backward when looking from the front. The next transformer in line is the output choke. This choke is mounted up close to the front panel. By observing the bottom of the transformer you will see that it also has a lead which protrudes down through the sub-base. In addition

there are two terminal lugs on the side of the transformer, three connections in all. When the holes on this transformer are matched up with those on the base, it will be seen that the only way in which the name on the taps may be read is by looking at them from the rear of the chassis.

The coils are next in line to be mounted and care should be taken to see that no mistakes are made in doing this. Each coil should be mounted first on the mounting brackets supplied for this purpose. The feet of the brackets must turn away from the coil and the bracket should be mounted on the inside of the coil. This is important, otherwise the bracket will rest against the primary winding and short circuit to ground. In mounting

the coil to the bracket be sure that the lugs point down to the sub-base and not up, otherwise it will be difficult to follow the accompanying picture wiring diagram. For those who wish to check the connection on the coils, the inside of the primary winding goes to the "B" battery leads, and the outside to the plate; the inside of the secondary goes to the filament lead, and the outside to the grid. The third or center tap on the primary of the antenna coil is not used unless it is desired to increase the selectivity of the receiver. The center tap on the antenna coil serves the purpose of reducing the primary winding to approximately one-third the number of turns, and it is advisable to move the lead from the aerial post, first to the outside tap and then to the center, determining which of the methods will produce the most satisfactory degree of selectivity for the location required. The variable condenser should be mounted in place by means of the three

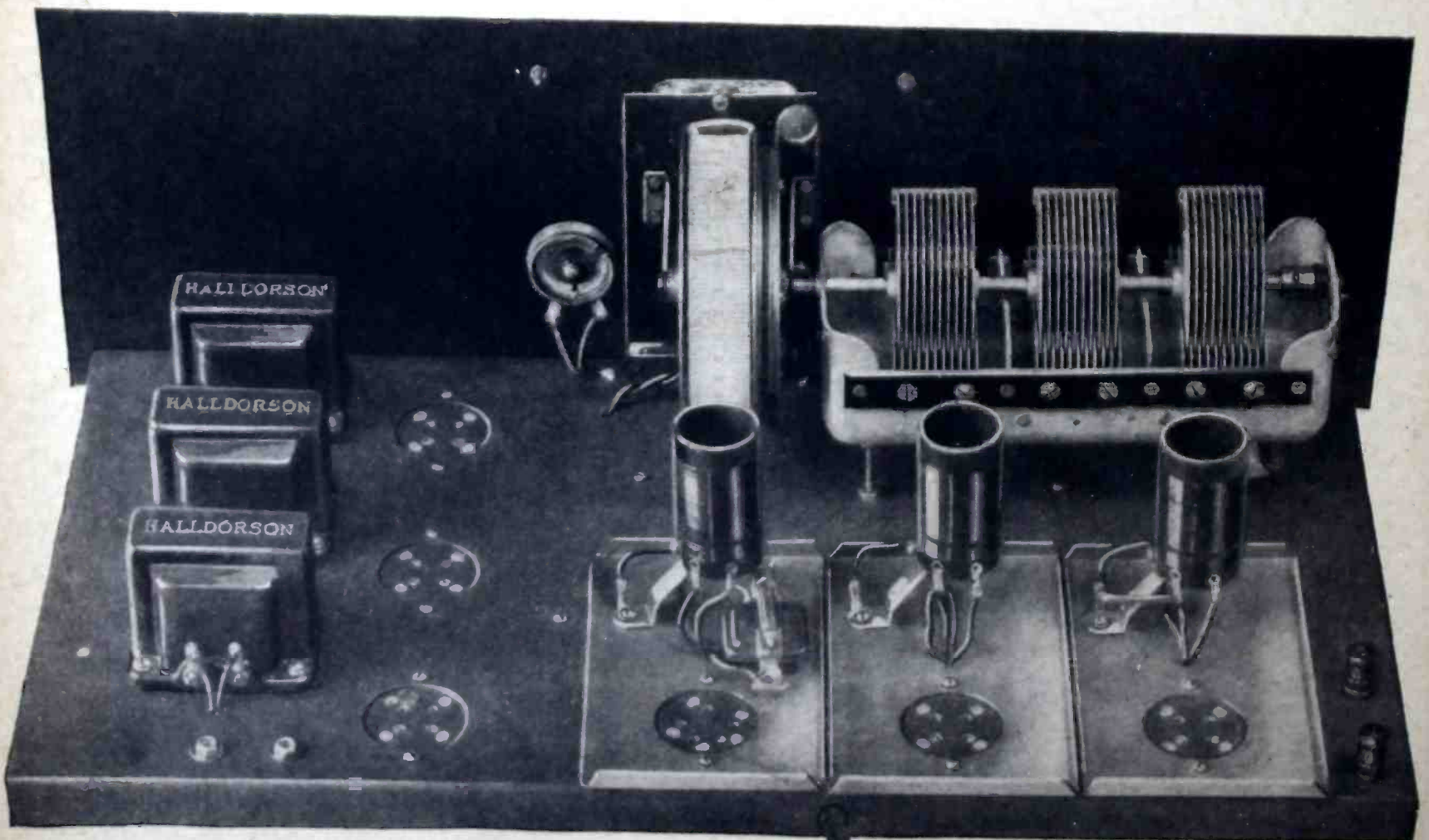


Schematic diagram of the Halldorson A.C. 56 set. The double pole switch is used to transfer from the radio to phonograph pick-up.

long machine screws and the  $1\frac{1}{4}$ " brass spacers supplied for this purpose. The dial, volume control and midget condenser should next be mounted upon the front panel, and the front panel may then be laid aside until the wiring of the sub-base is completed, the midget condenser is mounted to the left of the dial and the volume control to the right. Caution! In mounting the midget condenser the metal panel can be depended upon to make one contact, but watch the two screws that hold the unit together. If they appear to touch the panel when the mounting nut is tightened a large washer should be placed over the shaft before mounting. If these screws short on the panel the midget and first tuning condenser will both be shorted. When the volume control is mounted see that the terminal which is connected to the anten-

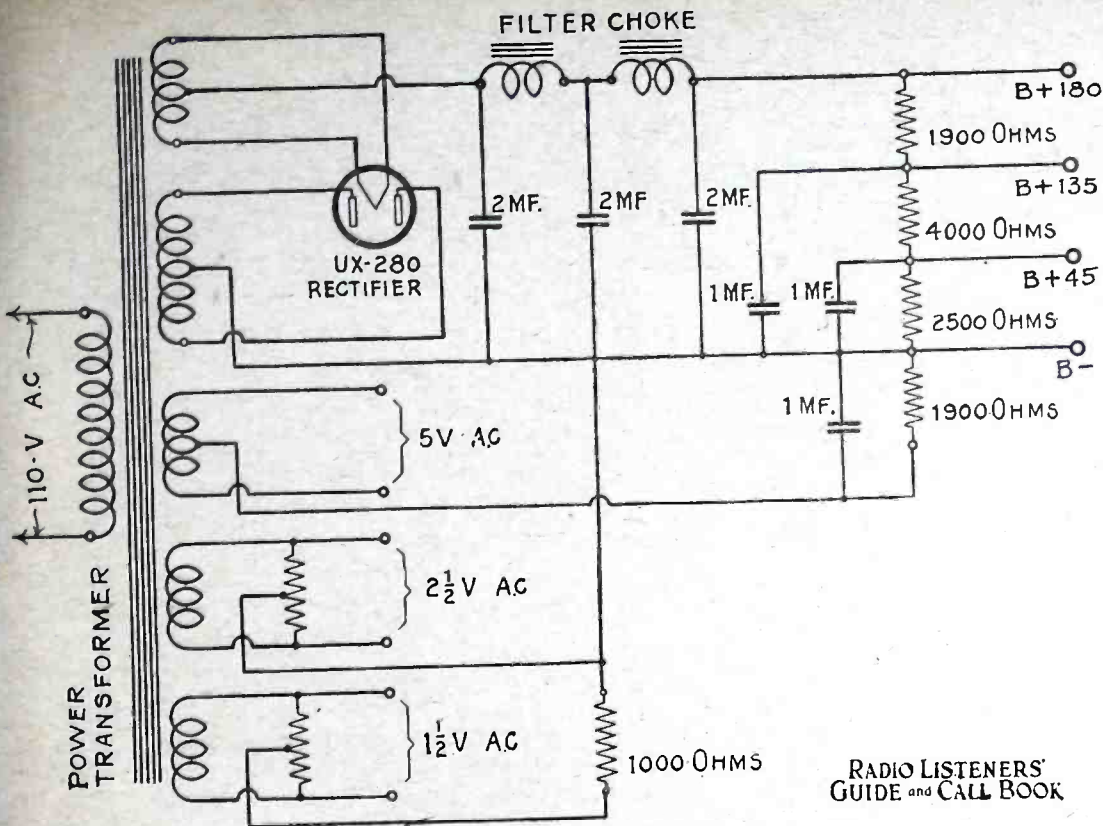
na is the one which makes contact with the wire and not the frame of control unit. When the terminal board is mounted do not neglect to space it with the  $\frac{1}{4}$ " spacers provided to keep the lugs from touching the metal base. The bypass condenser should be mounted in position between the first and second and second and third tube sockets, but it will be found that they are supported only by one lug at the back. The enamel should be scraped from around the front by-pass mounting lug between the two terminals and the lugs soldered directly to the base. This will hold it solidly in place and at the same time it will be noticed that one side of each condenser is grounded, consequently the grounded terminal may be connected directly to the soldered point by means of a very short piece of wire. The phonograph change-

over switch, which is mounted on the rear, should be carefully watched for short circuits. Because of the fact that this switch is very close to the metal panel, extreme care should be taken to see that the insulating bushings fit in place properly so as to eliminate any danger of shorts. The same precaution should be taken also for the loud speaker tip jacks and the two binding posts. The ground binding post, inasmuch as it is connected to the chassis, does not require insulation, but for the antenna binding post several little bakelite washers will be found among the hardware, one of which should be placed over the screw before the nut is tightened down. Wherever a grounded contact is shown, it is advisable to scrape the paint from the chassis and solder a wire in order to be sure of perfect contact. In order to



The rear of the set with shields removed. At the right are the R.F. stages and at the left the first A.F. and push-pull amplifier.





Wiring diagram of the special power supply unit employed in conjunction with the receiver.

balance up the trimmer condenser at the side of the 3-gang unit, a station should be tuned in and then reduced in volume so that it is just audible. The trimmers can then be balanced with the fingers, or preferably with a little tiny spanner wrapped with friction tape at the end where it is held. In any event the trimmers are not very critical and by dusting them slightly with the fingers and then removing the hand, it will be noticed im-

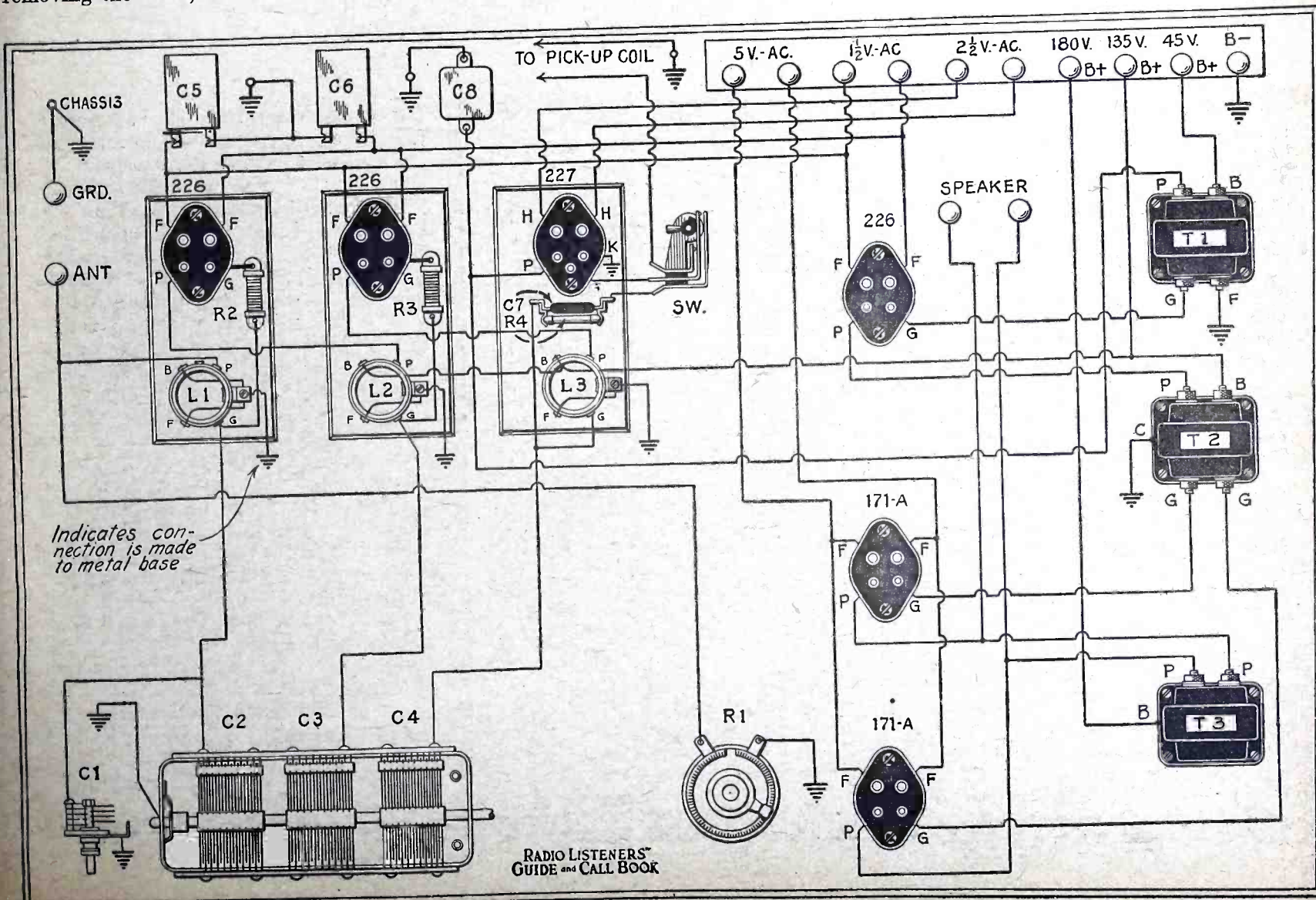
mediately which way the screw should be turned in each case for the maximum volume.

The most important point to remember on the receiver, assuming that everything else is operating satisfactorily, are the two resistances used in the grid circuit of the R.F. These two units particularly control the sensitivity and the volume obtained from the sets. It will be found that there is an adjustment on each unit.

LIST OF PARTS

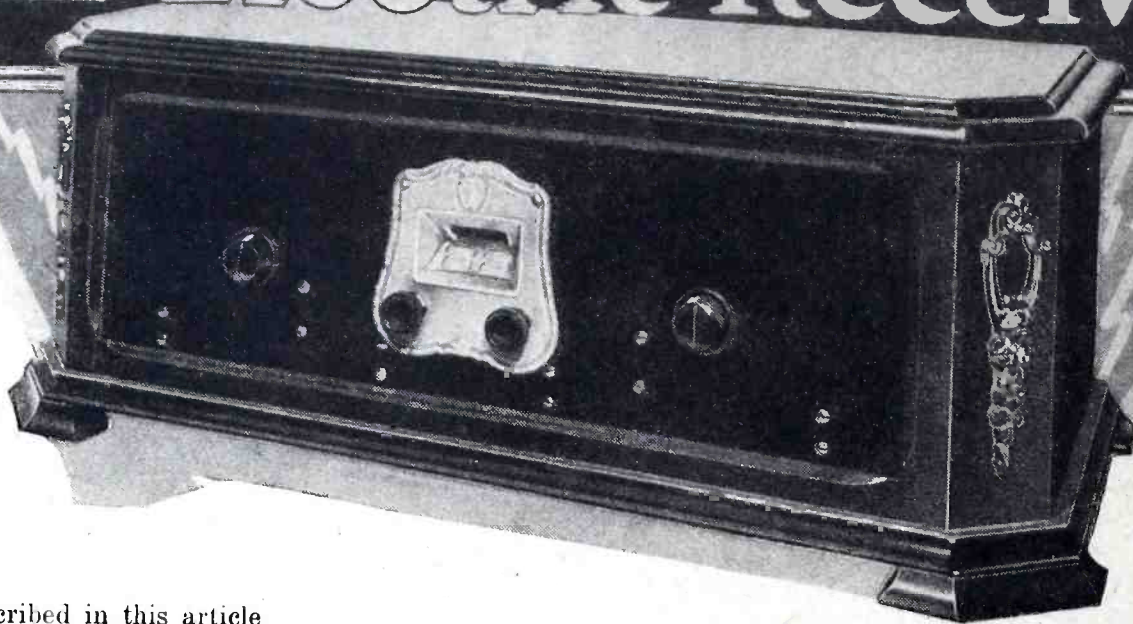
- 1 Halldorson steel panel, drilled
- 1 Halldorson steel sub-base with sockets and shield bases, 10 1/2 x 20
- 2 Halldorson binding posts
- 1 Halldorson .002 mfd. condenser, C8
- 1 Halldorson .00025 mfd. condenser, C7
- 1 Halldorson 3 meg. grid leak, R4
- 2 Halldorson .5 mfd. condensers, C5, C6
- 1 Halldorson escutcheon plate
- 1 Halldorson drum dial
- 1 Halldorson trimmer condenser, C2
- 1 Halldorson volume control, R1
- 3 Halldorson R.F. coil brackets
- 1 Halldorson antenna coil, L1
- 2 Halldorson R.F. coils, L2, L3
- 1 Halldorson 3-gang condenser, C1, C3, C4
- 2 Halldorson grid resistors, R2, R3
- 1 Halldorson large knob
- 2 Halldorson small knobs
- 2 Halldorson speaker tip-jacks
- 1 Halldorson push-pull input transformer, T2
- 1 Halldorson output choke, T3
- 1 Halldorson audio transformer, T1
- 1 Halldorson phonograph switch, SW
- 1 Halldorson terminal board
- 1 Halldorson connecting cable, 10 wire
- 1 Coil Halldorson hook-up wire and 1 piece 8" spaghetti
- 3 Halldorson copper stage shields
- 1 Package hardware.

These should be gently slid so that no resistance is in the circuit when the set is first tested. Upon tuning in a station, (Continued on page 112)



Picture diagram of the set showing how all parts are connected.

# How to Build a Screen Grid All-Electric Receiver



**T**HE receiver described in this article is exceptionally well adapted for home use. It is very simple to operate, extremely easy to construct, costs less than seventy-five dollars to build complete including tubes and cabinet, and compares in appearance both inside and out with the best that can be obtained in the market at more than twice its cost.

The receiver is compact and self-contained, including in one unit both receiver and power pack; so that all that is necessary to place it in operation is to plug it into a light socket.

It is stable in operation, requires no critical adjustment, is selective enough to tune from station to station without interference, and will bring in stations up to 1,000 miles away with more than enough volume to dance to.

In designing the receiver particular stress was laid on the importance of tone quality without any sacrifice in volume. Careful design of the audio circuit and the use of push-pull amplification leaves nothing to be desired on this score.

In its essentials, the circuit of this receiver consists of one stage of tuned radio frequency amplification, a detector stage, a stage of transformer coupled audio frequency amplification, another stage of audio frequency amplification using impedance coupling and a final stage of audio amplification using two power tubes connected in push-pull arrangement.

An A.C. screen grid tube is employed in the radio frequency stage. The use of this tube with a suitable circuit and the associated equipment as in this receiver provides greater sensitivity with this single stage than can be obtained by the use of two stages of the standard type of radio frequency amplification using 201A or 226 tubes. When properly used, this tube gives an amplification of 30 per stage at broadcast frequencies as against an average of less than five per stage for the other types of tubes mentioned. The extremely low inter-electrode capacity of this tube also eliminates any tendency towards oscillation, the need for

## LIST OF PARTS

- 2 Kelford No. 352, .00035 mfd. variable condensers, C1, C2
- 1 Aerovox type 1450, .00025 mfd. moulded mica condenser, C3
- 1 Aerovox type 1475, .00025 mfd. moulded mica condenser, C4
- 4 Aerovox type 1450, .006 mfd. condensers, C5, C6, C7, C8
- 1 Aerovox type 1450, .002 mfd. moulded mica condenser, C9
- 3 Aerovox type 250, .5 mfd. bakelite case condensers, C10, C11, C12
- 1 Aerovox type 250, 1 mfd. bakelite case condenser, C13
- 2 Twin Coupler, 80 millihenry R.F. choke coils, CH1, CH2
- 1 No. 1283 double drum dial
- 2 Kelford No. 285 tip jacks, J1, J2
- 1 Kelford power unit No. 360
- 2 Electrad type E, 0-500,000 ohm Royalty potentiometers equipped with walnut knobs, R1, R2
- 1 Aerovox type 1098, 1,000 ohm Lavite, R3
- 1 Aerovox type 1098, 50,000 ohm Lavite, R4
- 1 Aerovox type 1092, 2 megohm grid leak, R5
- 1 Aerovox type 992, 750 ohm Pyrohm resistor, R6
- 1 Aerovox type 992, 1,000 ohm Pyrohm resistor, R7
- 2 Aerovox type 985, 10 ohm center tapped resistors, R8, R9
- 1 Aerovox type 985, 50 ohm center tapped resistor, R10
- 3 Eby type UY, five-prong sockets
- 5 Eby type UX, four-prong sockets
- 2 Twin Coupler No. 222 Shield Grid Plug-in coil kit, T1, T2
- 1 Kelford Gain transformer, T3
- 1 Kelford No. 310 twin unit push-pull transformer, T4
- 1 Twin Coupler tube shield
- 2 Pairs of sub-panel brackets, and miscellaneous hardware
- 1 Bakelite front panel, 7x21x1/8"
- 1 Bakelite sub-panel, 10 1/2 x 20 1/2 x 1/8"
- 50ft. Corwico Braidite hook-up wire.

critical adjustment and any tendency to cause interference.

This stage of radio frequency amplification feeds into a detector stage which employs a 227 type heater tube. No attempt has been made to use regeneration in the detector stage because of the additional tuning control and instability which the use of regeneration involves. The exceptional sensitivity of the screen grid amplifier stages makes it unnecessary to rely on regeneration to supply the sensitivity usually lacking in single stage amplifiers.

The first stage audio transformer and the choke coil for the second audio stage are both contained in the gain transformer unit, "T3." Volume in the audio stage is controlled by means of the high resistance potentiometer "R2" connected in the grid circuit of the second audio stage.

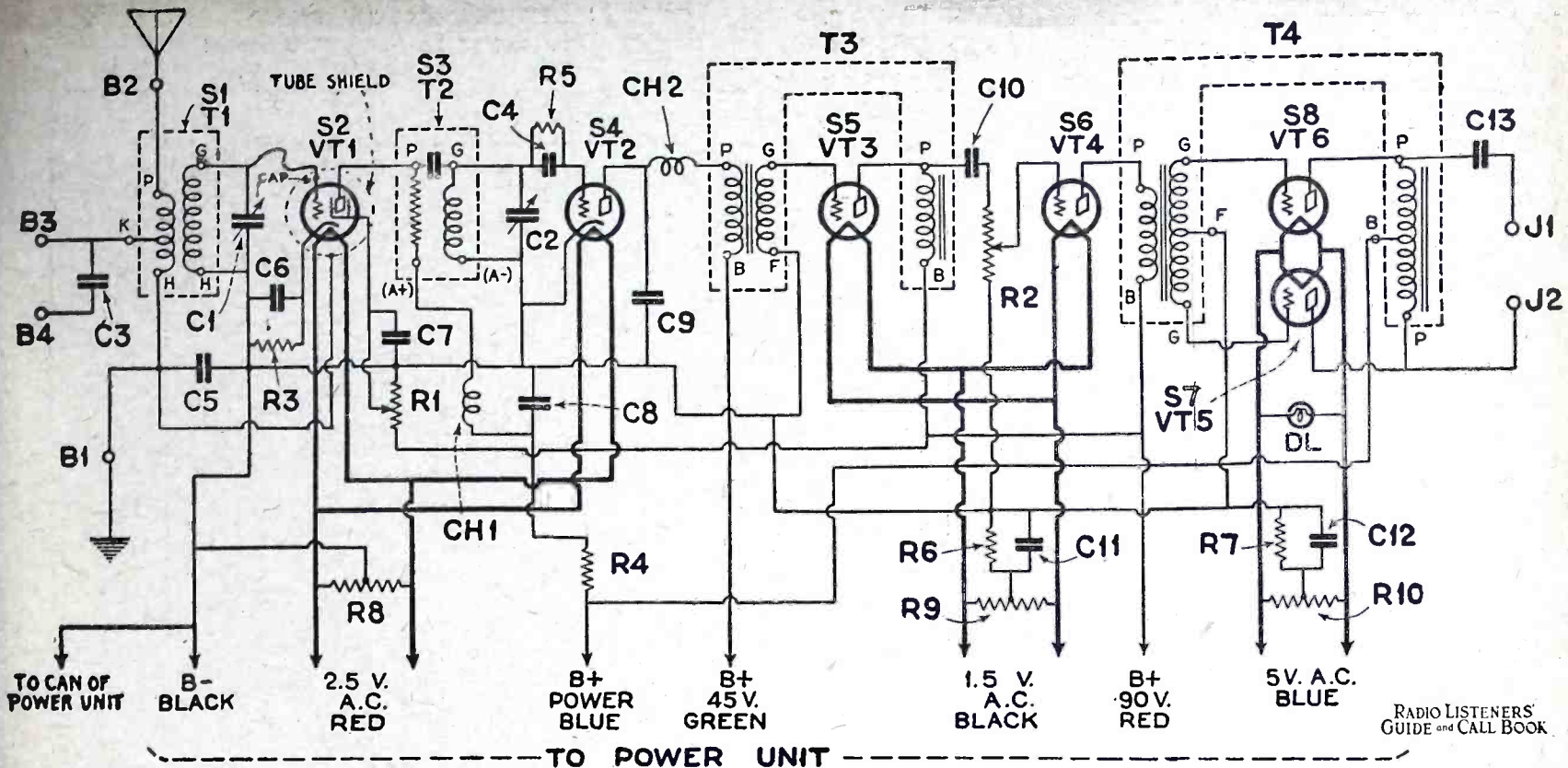
The last stage consists of two 171A tubes connected in push-pull arrangement to give maximum amplification and volume without distortion. Both the input transformer and the output choke unit are contained in a single housing.

The location of the parts on the panel and sub-panel are clearly shown in the photographs and the layouts. The first step in mounting the parts is to mount the double drum dial on the front panel.

The next step is to mount the variable condensers in the positions shown. When properly placed, the shaft of the condensers will line up with the shaft hole of the dial. Only two screws are used to mount each condenser.

Next mount the high resistance potentiometers "R1" and "R2" with the terminal ends towards the bottom edge of the panel so that the soldering lugs project just below the level of the sub-panel when the front panel and sub-panel are assembled.

The next step is to mount the sub-panel brackets on the panel, with the bent over edges facing toward the center of the



Schematic wiring diagram of the Screen Grid All-Electric receiver described in this article.

panel and the cutout portion of the front edge of the bracket away from the sub-panel, so as to allow the bracket to fit over the front crosspiece of the cabinet. The 1/2-inch, 6/32 bronzed oval head screws should be used for this purpose and it is advisable to use an extra nut on each screw to serve as a lock nut.

Next place the sub-panel on the tops of the brackets, with the bottom side of the sub-panel towards the brackets.

The countersunk mounting holes on the sub-panel have been laid out to allow a distance of almost half an inch between the front edge of the sub-panel and the rear face of the front panel, so that if the sub-panel is placed in this position,

no trouble will be experienced in locating the countersunk holes used to mount the sub-panel on the brackets.

Next mount all the sockets with the terminals in the positions as shown in the accompanying layout.

Mount the .5 mfd. fixed condensers "C10," "C11," "C12," and the 1 mfd. condenser "C13" as shown in the layout, using the 1/2"x6/32 oval head blued screws with the heads on the top side of the sub-panel. The terminals of these condensers should be bent over to avoid any possibility of projecting past the brackets and also to simplify connections.

The .002 mfd. condenser "C69" should

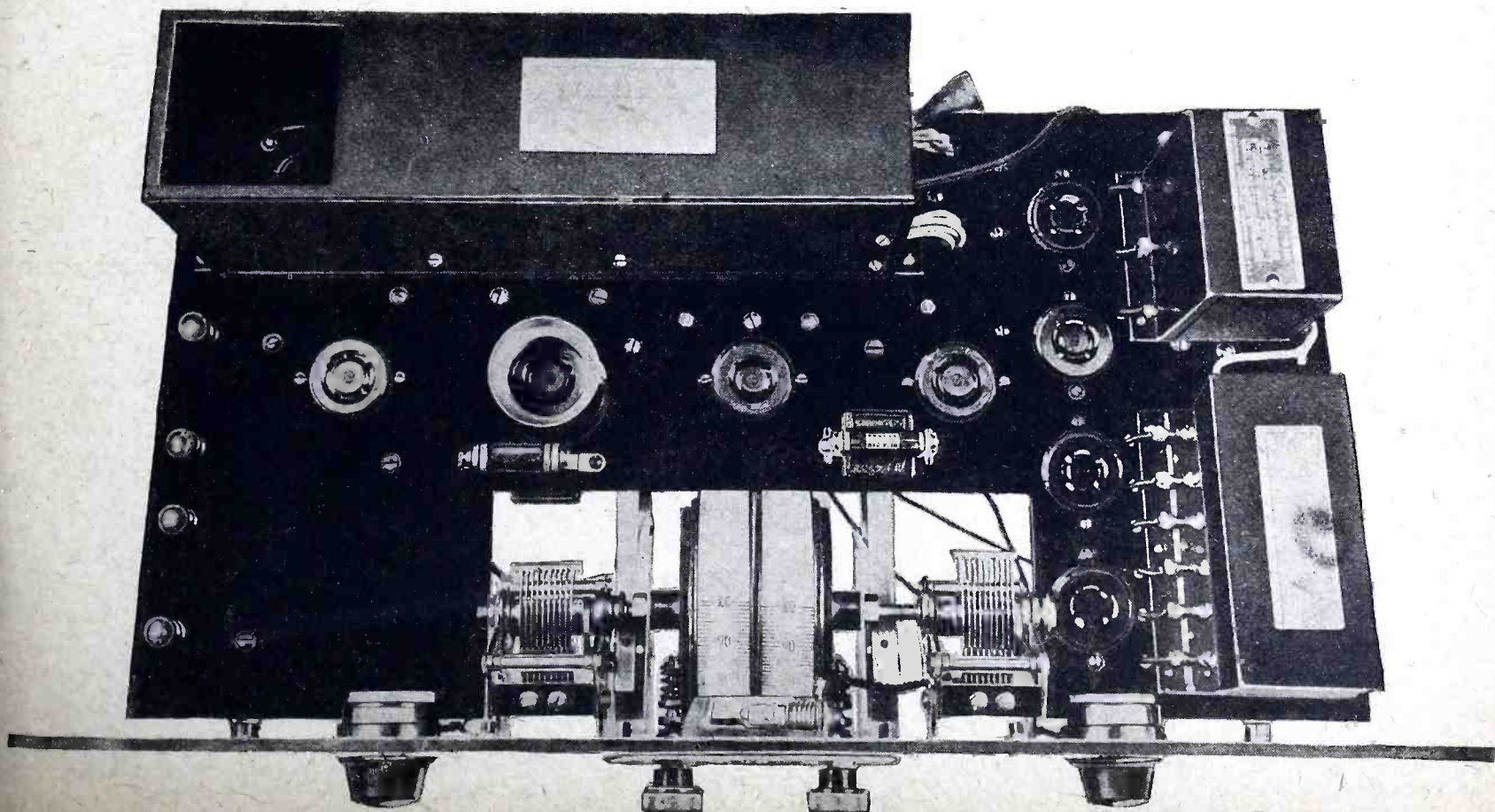
be mounted as shown beneath the panel.

The 50,000-ohm Lavite "R4" is mounted by using a set of grid leak mounting clips but in this case the proper mounting distance is obtained by facing them towards each other.

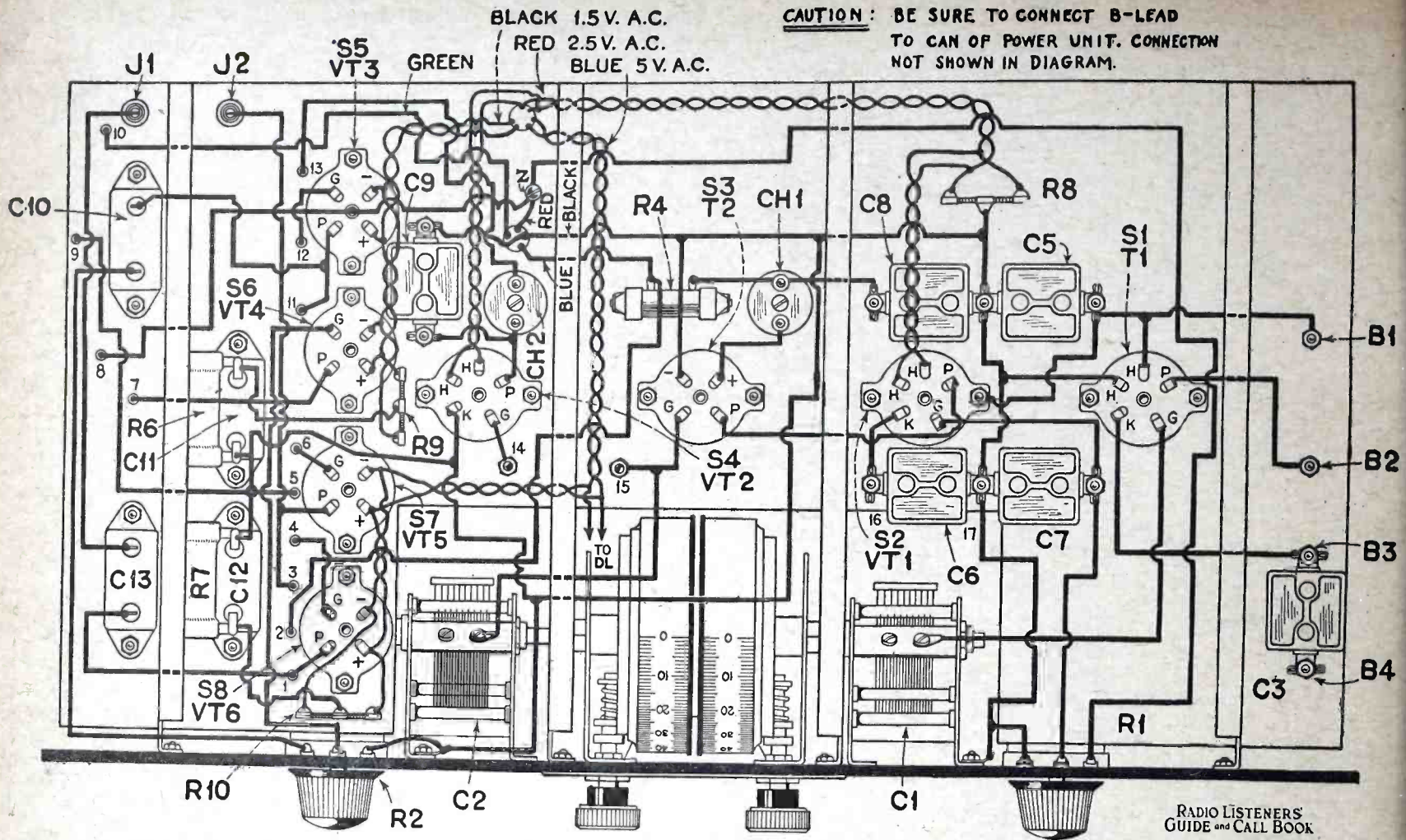
Choke coils "CH1" and "CH2" should be mounted on the under side of the sub-panel as shown in the layout.

Next mount the grid condenser "C4" and the grid leak "R5" on the top of the sub-panel, using 1/2"x6/32 round head screws for the purpose.

To avoid the necessity for splicing the "90-volt" lead, from the power pack, which is connected to the high resistance potentiometer "R1" in the screen grid



Above is a top view of set as it appears when completed. The power unit can be seen mounted on the sub-panel in the rear.



Pictorial wiring diagram of the receiver. All parts are indicated to correspond with the instrument layout and list of parts accompanying this article.

tube circuit and also to the "B" terminals of transformers "T3" and "T4", an anchor terminal, "Z", has been provided which is located between the two large holes through which the leads from the power pack are carried.

The 10-ohm resistor "R9" is rigidly fastened to the sub-panel by slipping one terminal over the socket mounting screw that is located between the "P" and "F" terminals of socket "S6."

The 50-ohm center-tapped resistor "R10" is mounted and connected in a similar way on socket "S8."

Next mount tip jacks "J1" and "J2." Then mount transformers "T3" and "T4" and the power unit. Mounting screws should be used in all the mounting holes except the one under the "F" terminal of transformer "T3."

The 750-ohm resistor "R6" is mounted by soldering it across the terminals of

condenser "C11." In the same way, the 1,000-ohm Pyrohm resistor "R7" is mounted by soldering it across the terminals of condenser "C12."

The wiring of the receiver is clearly shown in the accompanying diagrams.

After all connections have been made it is advisable to check up each connection carefully, checking back between the set and the schematic diagram and also the pictorial wiring diagram. The importance

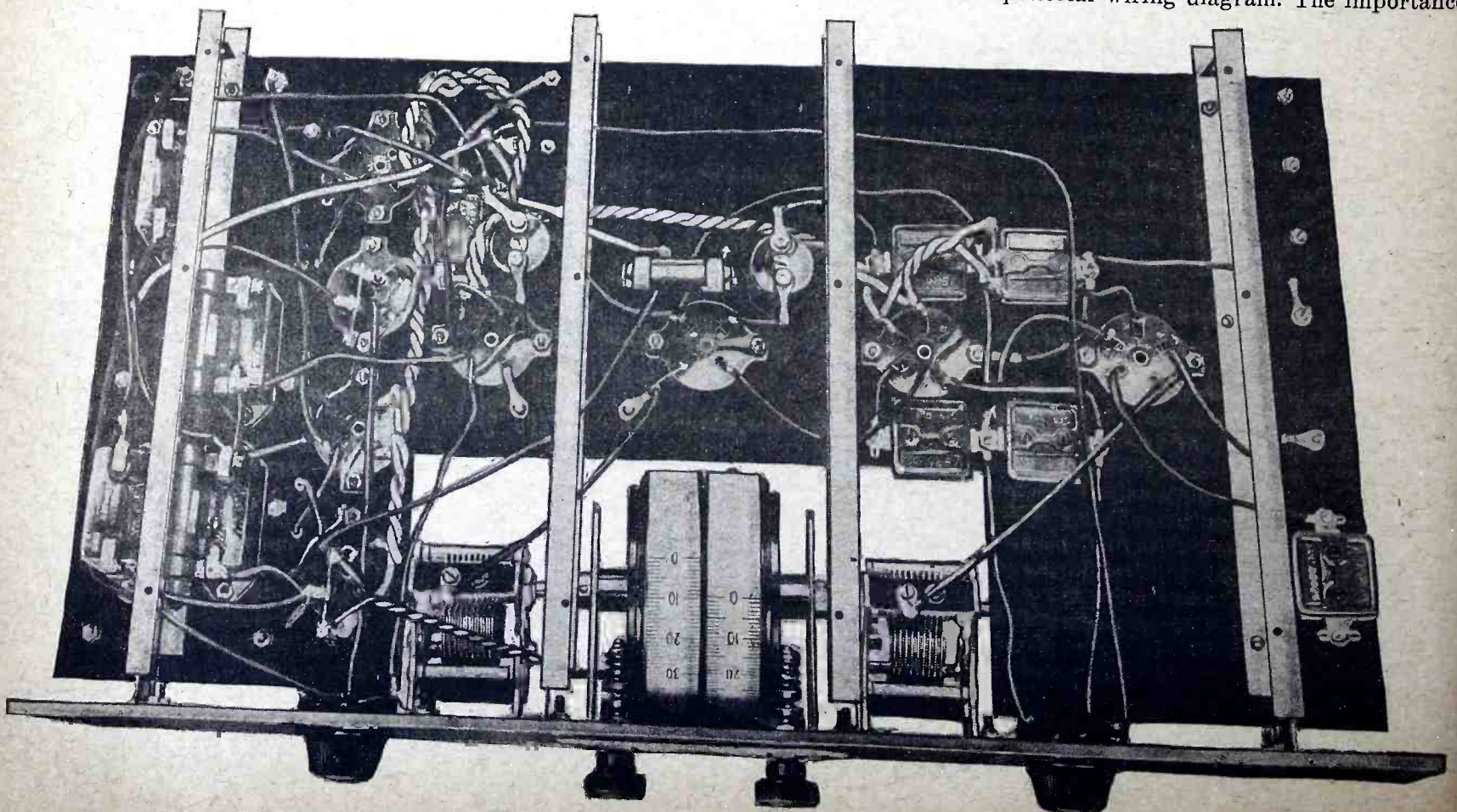


Photo of the set from beneath the sub-panel showing the location of parts and wiring.

of checking the wiring to make sure that no connections have been omitted and also that no wrong connections have been made, cannot be stressed too strongly.

No tricky or special adjustments are necessary to put this receiver in operation. There are no balancing adjustments, no oscillation controls or any of the other troublesome adjustments required on most receivers.

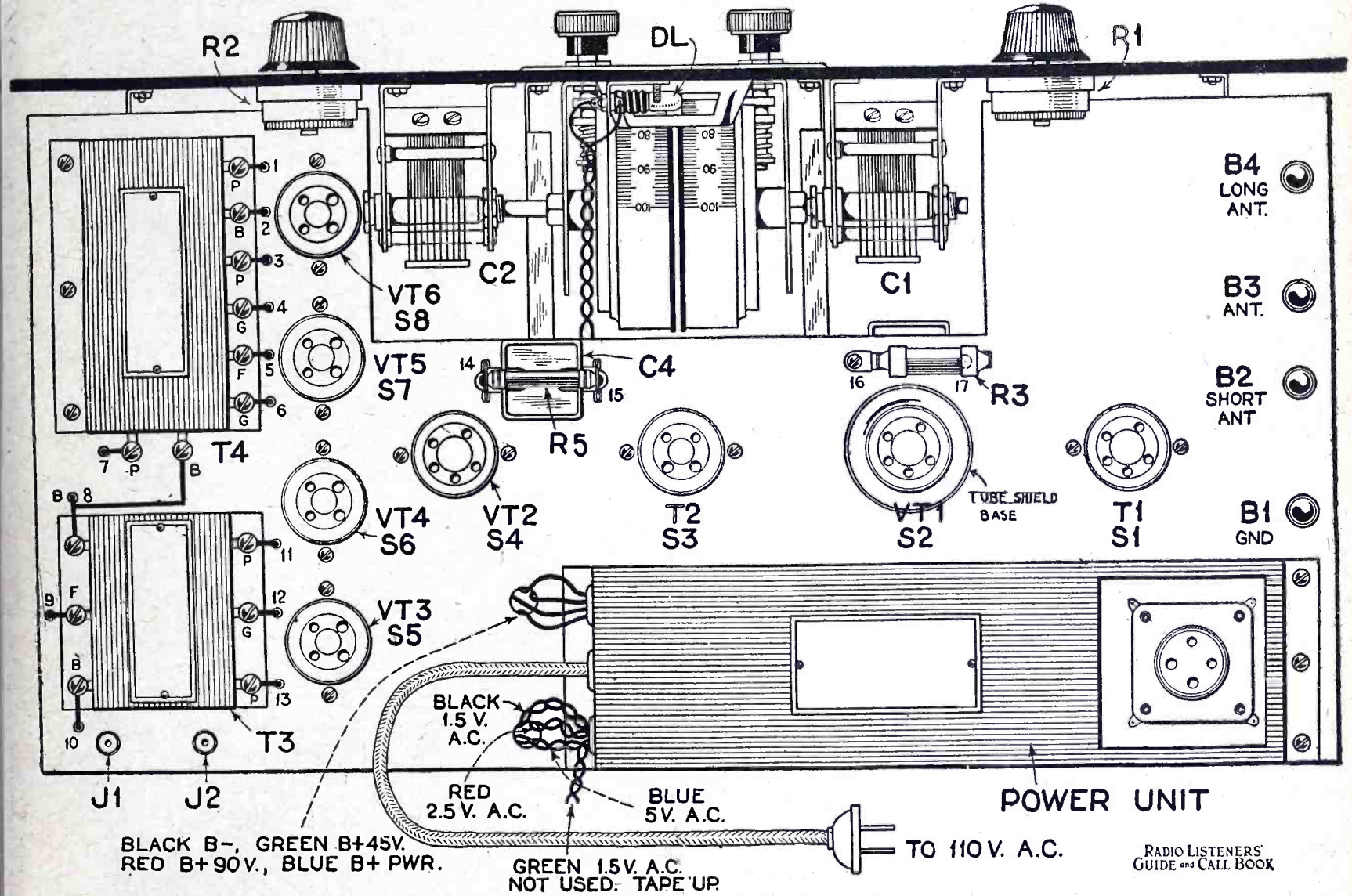
The first step consists simply in lining

The 226 tubes are inserted into sockets "S5" and "S6," while the 171A tubes are inserted into sockets "S7" and "S8."

Since the arrangement of prongs and the sockets used for both the 226 tubes and the 171 tubes are the same although the 226 tubes operate at only 1.5 volts while the 171A tubes operate at 5 volts it is very important that the tubes be put into the proper sockets. If the 226 tubes are placed in sockets "S7" or "S8" the

uses the full primary coil of the tuning transformer and therefore gives maximum sensitivity but with comparatively broad tuning.

Where interference is more troublesome and maximum sensitivity is not necessary as is the case within fifty miles of a number of powerful broadcasting stations or where a fairly long antenna is used, best results will be obtained by using antenna binding post "B3."



Instrument layout of the receiver. Note that the sub-panel is cut away so as to allow space for the variable condensers.

up the variable condensers by loosening the shafts in the condensers, turning the condensers so that the rotary plates are entirely in mesh with the stationary plates (the setting for maximum capacity) and then turning the dial to the "100" setting and tightening the set screws on the condenser shaft.

Next insert the screen grid tube "VT1" into socket "S2." Then slip the shield over the tube so that it fits over and meshes over the bottom portion of the shield which has already been mounted on shield "S2." The control grid terminal of the tube will then project through the insulated hole provided at the top of the tube shield. The No. 222-A antenna unit, "T1" can then be plugged into socket "S1" and the clip at the end of the flexible wire lead provided at the top of this unit can be fitted over the cap terminal of the screen grid tube.

Then plug the No. 222-C detector unit "T2" into socket "S3."

The 227 detector tube is inserted into socket "S4."

high voltage will blow out the filaments of the 226 tubes and ruin the tubes. It is also important to remember that the receiver should not be connected to the light socket unless all the tubes are in their sockets.

The 280 rectifier tube should then be placed in the socket of the power unit.

Next check up to make sure that the grid leak "R5" is in place in the clips of the condenser "C4", that the 1,000-ohm Lavite "R3" and the 50,000-ohm Lavite "R4" are in place in their respective clips as shown in the layout diagrams.

Now all that is necessary is to insert the tips of the loud speaker into tip jacks "J1" and "J2," connect the ground wire to the ground binding post "B1" and the antenna wire to one of the antenna terminals and plug the receiver into the light socket. For maximum sensitivity and volume where interference is not troublesome as for instance in outlying sections, or where only a short antenna is used, the antenna wire should be connected to binding post "B2." This connection

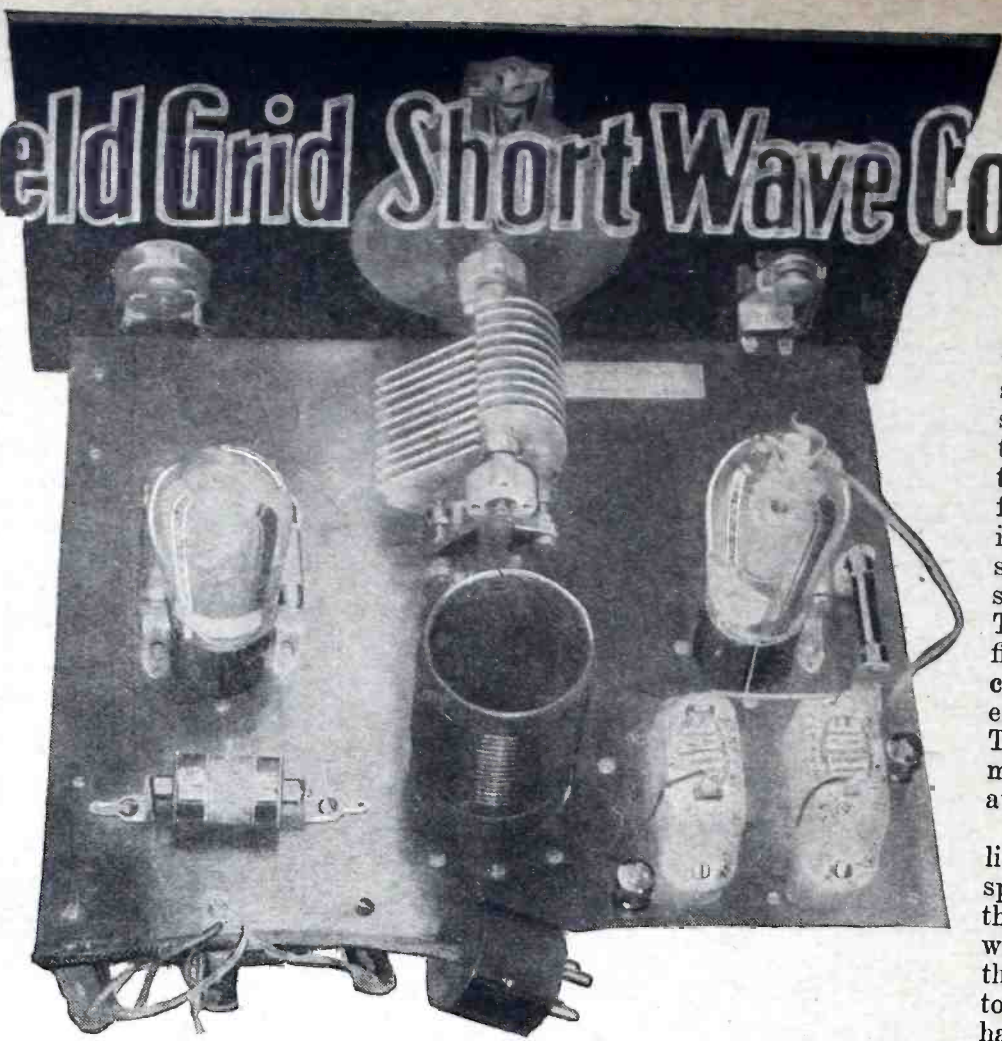
For use within a very short distance of powerful broadcasting stations where maximum selectivity is essential it is best to use a comparatively short antenna connected to binding post "B4." This connection provides a fixed condenser in series with the tap on the primary coil and will give very good selectivity at a slight sacrifice of sensitivity. The sacrifice of sensitivity in such cases is negligible because of the power which the receiver is capable of delivering even on a weak signal.

The setting of the two variable tuning condensers will depend largely on the antenna which is used with the set. Once proper antenna binding posts have been selected to give desired results in the particular location in which the set is used, it is possible to tune in a station to its best point on both dials and then reset the dials to read the same. Then for all other stations the dials will read approximately alike and make the tuning of the receiver simpler by eliminating the necessity of remembering different settings on each dial.

# A Shield Grid Short Wave Converter

AS the one stage R.F. with regenerative detector rapidly became the outstanding circuit arrangement in home-built receivers during the great broadcast era, so has a similar circuit taken the short wave field. With this type of set just beginning to be appreciated, vast numbers of parts have been sold for these receivers.

The circuit used in short waves, however, uses an untuned input rather than a tuned antenna circuit, and in this way differs from the accepted broadcast practice. This tube has several purposes. It permits the use of an antenna of any length without adjustment; it gives some amplification to the incoming signal; and most important of all, it prevents squeals from going out to the neighboring sets. This latter point may not impress some of our recent lis-



Any old tube may be used for the plug-in socket base. The glass should be broken and the other material in the base cleaned out. The four brass tips will come into view, and the necessary connecting leads should be soldered to these. The plug may then be filled with wax. This takes care of three of the four external leads to the set. The 135-volt connection is made onto a binding post at the rear of the unit.

Readers have perhaps little idea of the radio sport that lies in wait for them down on the shorter waves. Up until this year there was so little to listen to except code that a set hardly seemed worthwhile, but now, any number of stations are broadcasting on these wavelengths. Stations all over the North American continent are heard during daylight hours, some of which cannot be heard even at night time on a good broadcast receiver.

But the real thrill comes in the trans-oceanic reception. 15SW, the British Broadcasting Company's station at Chelmsford, England, can be picked up from five on until seven p. m. Eastern Standard Time, and under favorable con-

present broadcast receiver, is described in this article. After completing it, one merely has to remove their detector tube and insert the plug of the converter in its place. The detector tube is then placed in the converter and you can then tune in around the world.

It hardly seems necessary to go into any specific constructional details, for the accompanying simplified picture and schematic diagrams tell the whole story.

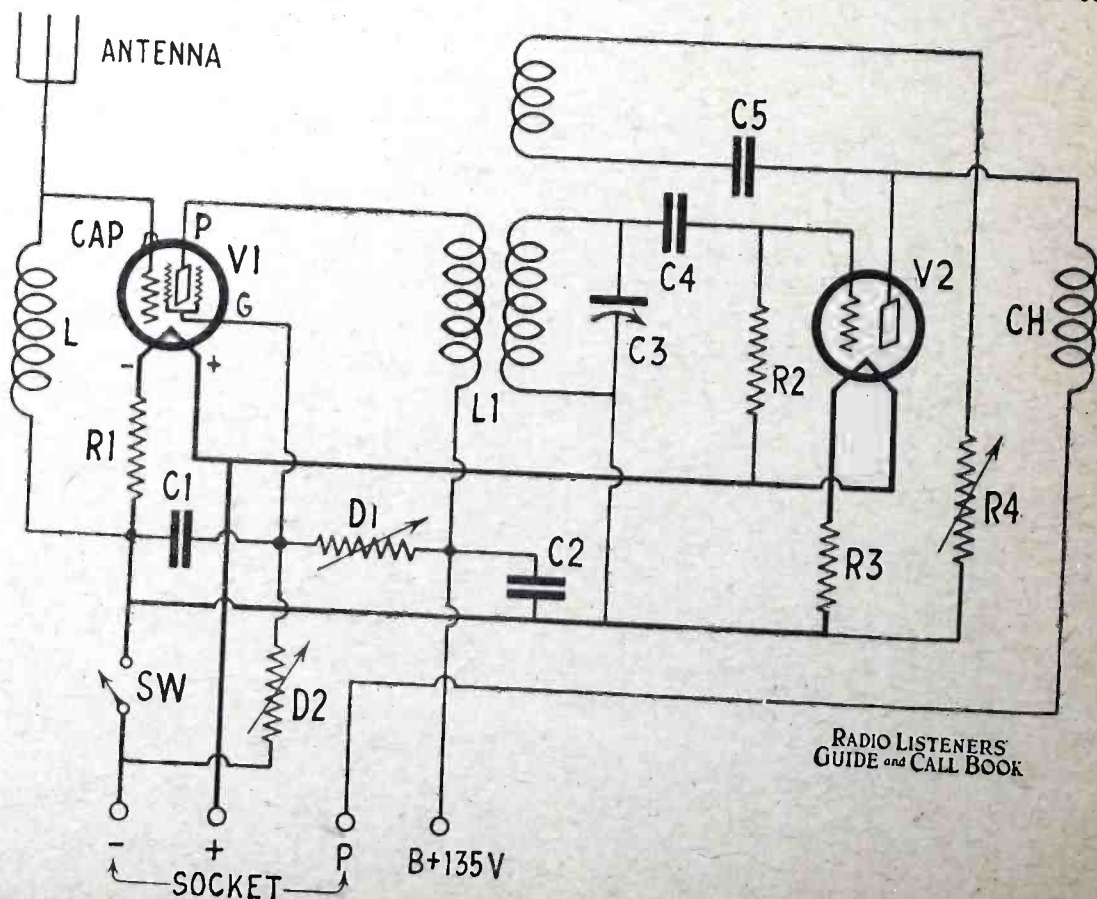
## LIST OF PARTS

- 1 National Short Wave Kit (consisting of front and sub-panels, set of plug-in coils, L1, tuning condenser, C3, and choke, CH)
- 1 Clarostat Grid Leak, R4
- 1 Tobe 8 meg. tipon leak, R2
- 2 Tobe .5 mfd. by-pass condensers, C1, C2
- 1 Clarostat Duplex, D1, D2
- 1 Tobe .00025 mfd. vacuum condenser, C4
- 1 Tobe .001 vacuum condenser, C5
- 1 622 Amperite, R1
- 1 1-A Amperite, R3
- 1 Yaxley switch, SW.

teners, but those who listened in two or more years ago will never forget the so-called "blooping" that characterized every evening's entertainment in those days. With the great increase in the number of short wave receivers, this same condition will occur down in those frequencies unless a blocking tube is used to prevent regeneration radiation.

A general impression among many people, not familiar with short waves, is that a completely new receiver must be built to get the myriad programs on the air down there. This is not the case, however. The short wave receiver differs only in the tuning section. From the detector on, the arrangement is identical with any broadcast receiver.

A simple converter which will permit one to use this most popular of short wave circuits, in connection with their

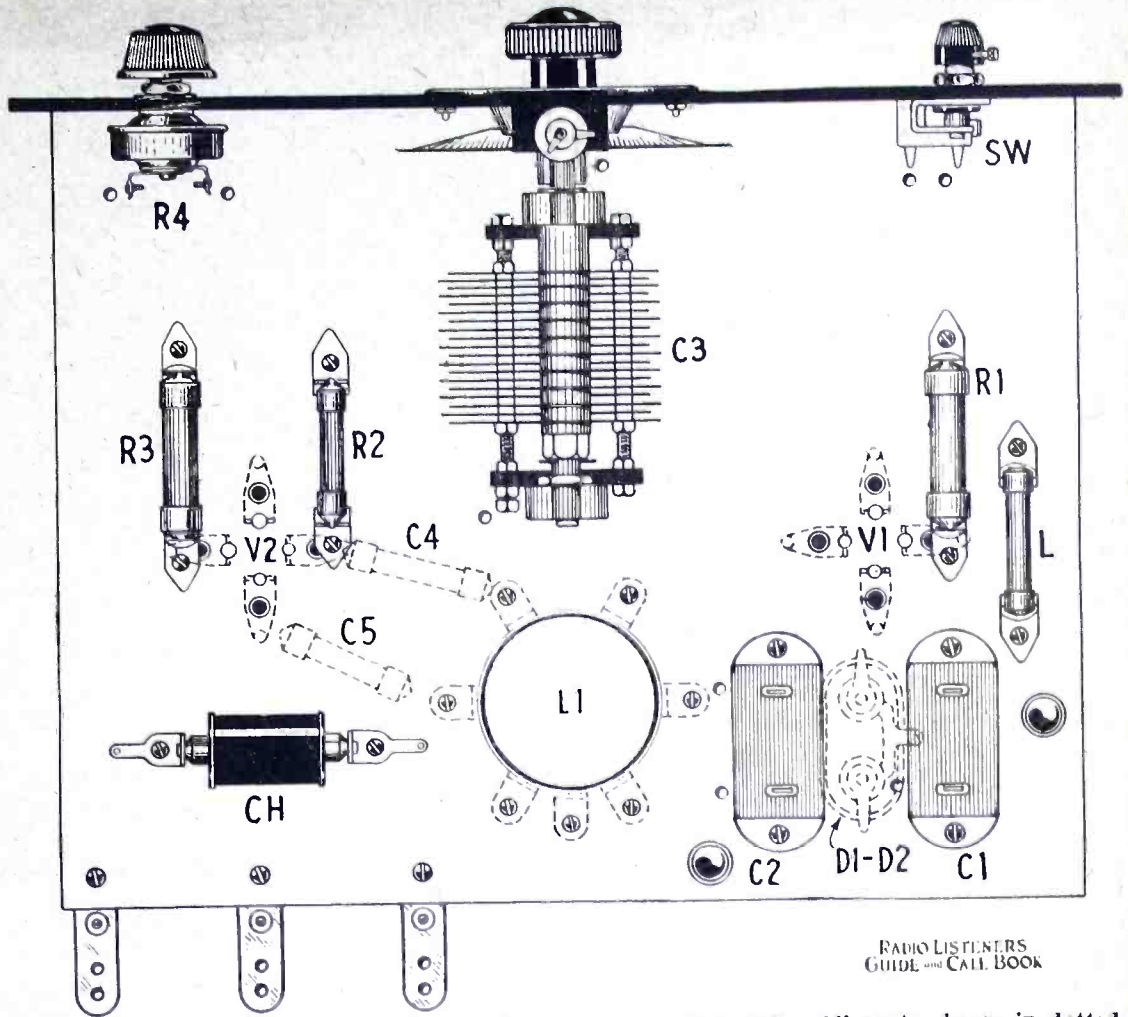


Schematic wiring diagram of the short wave converter unit as described in this article. Parts are indicated to correspond with list of parts, layout and picture wiring diagram.

ditions may be brought up to loud-speaker strength. This station usually closes with an hour of dance music, and when you can clearly hear the music, dancers' voices, the hand clapping for encores from the Savoy Hotel in London, right from your own loud speaker, you are getting real radio thrills.

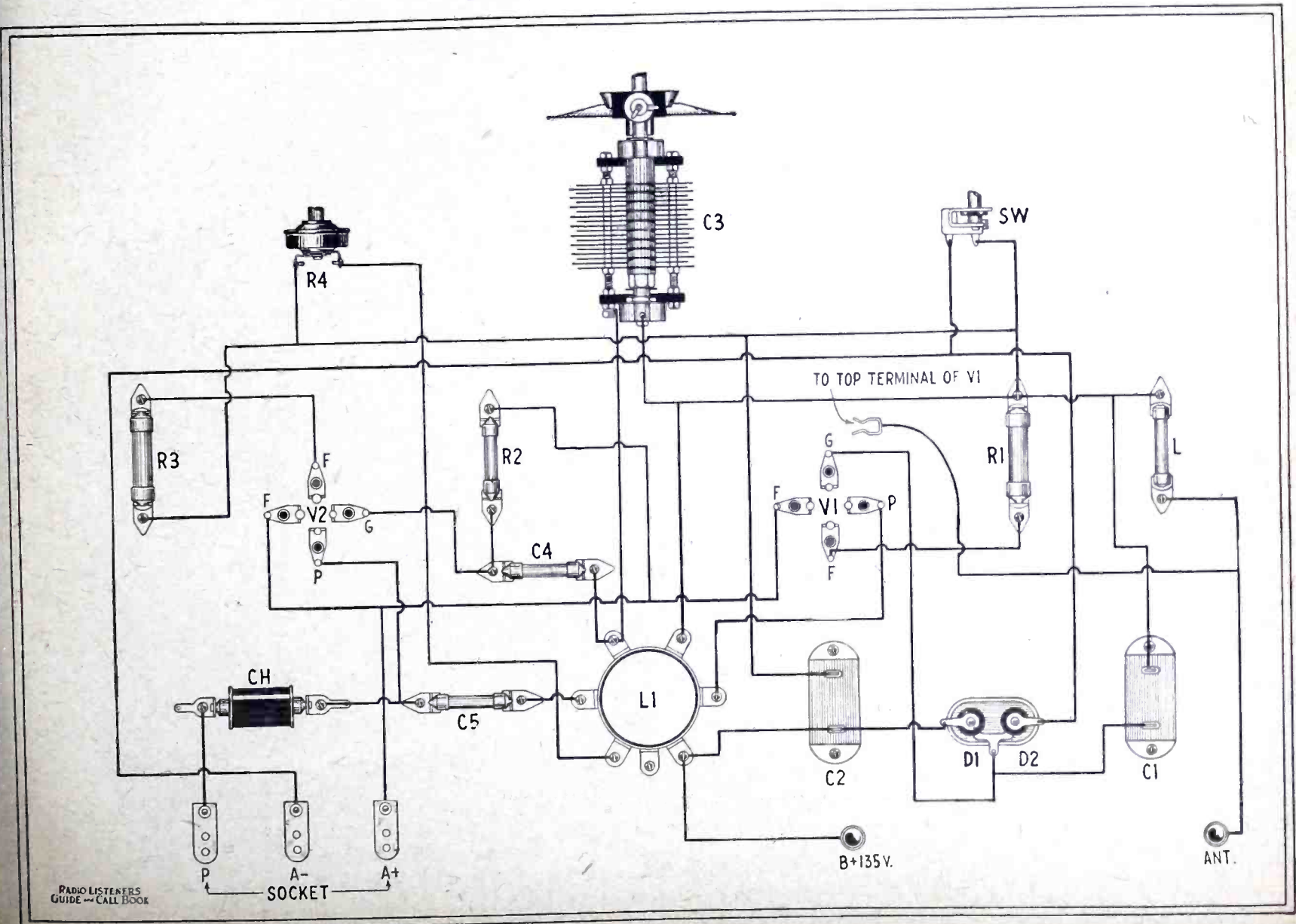
Now Germany is just completing a powerful short wave station with which they expect to broadcast excellent programs to the whole world. A particularly strong station is the one in Eindhoven, Holland, which puts on regular programs for use in the Dutch colonies and other remote points. This station is more widely heard than any other short wave station in the world according to many reports. The thoughts of getting distant places like these usually conjure up visions of super-price receivers using fourteen tubes, and totally out of the reach of the average fan to build, buy or operate. But, thanks to the gift of short waves, this is not the case. Just build up the little simple unit described herewith; connect it to your present broadcast receiver, and like Monte Cristo, you can say, "The World is mine!"

This converter unit can also be used in conjunction with a suitable amplifier for the reception of television transmissions on short wavelengths.



RADIO LISTENERS' GUIDE AND CALL BOOK

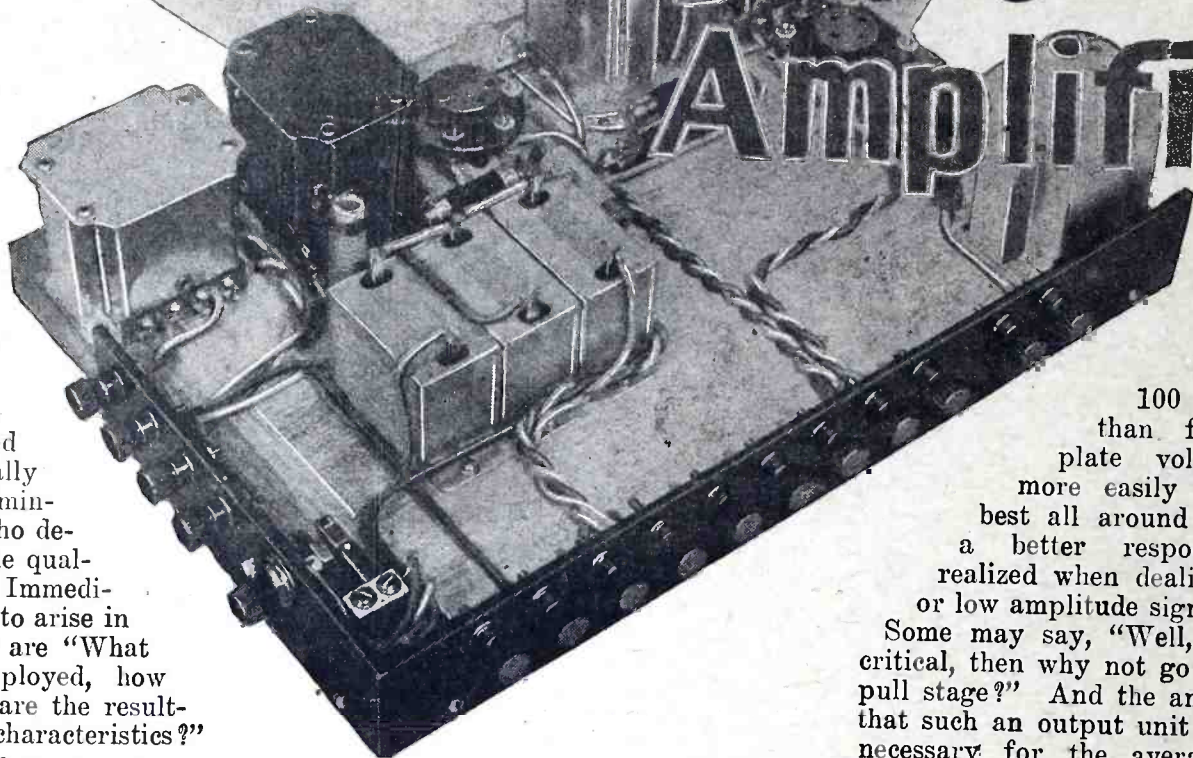
Instrument layout of the shield grid short wave converter unit. All parts shown in dotted lines are mounted beneath the sub-panel.



RADIO LISTENERS' GUIDE AND CALL BOOK

A picture wiring diagram of the unit is given above for the constructor who prefers to wire the apparatus from this type of diagram.

# A High Quality Radio and Phonograph Amplifier



THE title of this article expresses the specifications of the amplifier to be described which has been especially designed for the discriminating radio set owner who desires to have utmost tone quality from his radio set. Immediately the first questions to arise in the mind of the reader are "What type of circuit is employed, how many stages and what are the resulting frequency and gain characteristics?"

Such questions are, of course, of paramount importance and must be answered. In many instances the set already has available a perfectly good radio frequency amplifier including detector which possesses ample selectivity; and long distance signal reception is of little or no importance. Therefore, all apparatus up to and including the detector can be used.

The fundamental purpose in view in designing this amplifier was that it should be suitable for use with both radio frequency circuits or in conjunction with a high grade phono pick-up so that the latter could be used for reproduction of phonograph record music. Quality reproduction was the principal consideration and a push-pull output stage became necessary; first because this stage must be capable of handling signals of large amplitude without fear of overloading. Secondly, it should be relatively free from frequency or signal shape distortion. It also appeared desirable to limit the plate voltage to a maximum of 180 volts—such as would be developed by a power device incorporating a type 280 rectifier tube.

An output power unit of this type would call for a push-pull stage using type 171-A tubes. But further analysis of the problem showed that the maximum instantaneous values of the tube low current was such as to cause a relatively large drop in effective plate voltage, so that it was doubtful whether a push-pull 171 stage should be considered. These facts are further brought out in an illuminating paper by M. Von Ardenne, which was recently prepared by the Institute of Radio Engineers. Lack of space in this

article does not permit a lengthy discussion of this interesting topic.

Another important feature generally overlooked where lo-mu power tubes are resorted to is the fact that the lower a power tube's amplification factor the

100 percent greater than for 171 types; plate voltage could be more easily maintained for best all around operation; and a better response would be realized when dealing with distant or low amplitude signals.

Some may say, "Well, if you are so critical, then why not go to a 250 push-pull stage?" And the answer, briefly, is that such an output unit is seldom made necessary for the average home; nor should one forget its low sensitivity, as previously pointed out.

Since the amplifier must also give quality reproduction from a phonograph pick-up it was thought best to make a little study as to proper means for coupling the pick-up to the first audio tube. Such devices are of relatively low impedance, and are not suitable for either direct connection across a tube input or if placed in series with modern transformer primary windings.

However, there has been developed an impedance balancing transformer or network which functions as an adjustable primary impedance for obtaining a best match for the pick-up proper; while its secondary windings possess correct impedance characteristics for working into our standard audio frequency transformers. With such an efficient combination it only becomes necessary to use a simple little jack switch for setting the amplifier input circuits so these may be connected to either the radio set or phono pick-up.

While ample loud-speaker volume was a requirement still it was felt that a properly designed two stage amplifier should prove every bit as good as the average attempt at three stage types, and further, with the latter one must always expect that audio frequency oscillation may take place, and thereby ruin the unit's characteristics.

And for the latter reasons it was decided to use high quality audio transformers. The transformers adopted and specified in the accompanying list of parts possess high primary winding inductance and impedance values. This

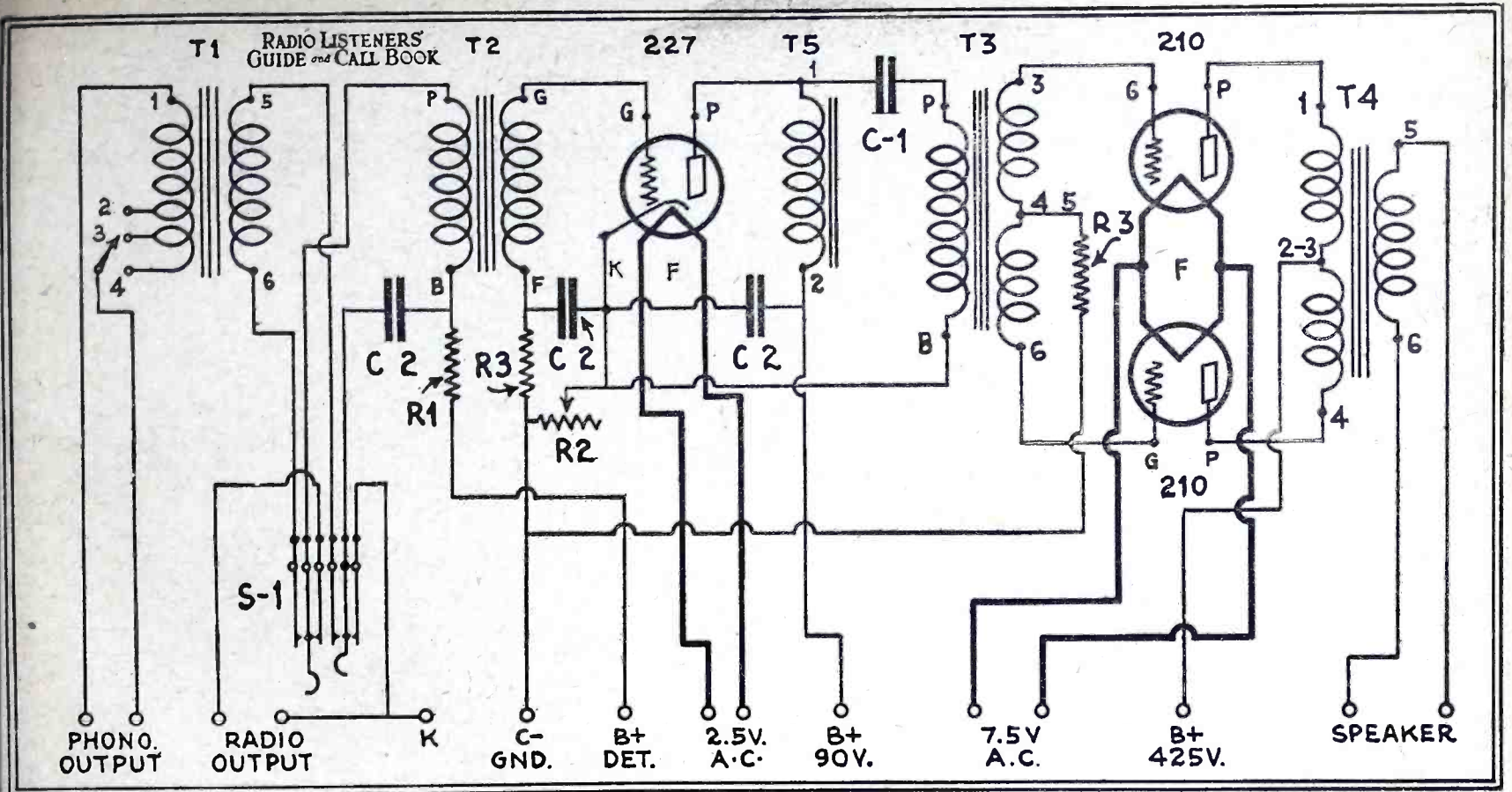
## LIST OF PARTS

- 1 Amertran type 389 equalizer transformer, T1
- 1 Amertran DeLuxe 1st stage transformer, T2
- 1 Amertran type 151 input transformer, T3
- 1 Amertran type 152 or 200 output transformer, T4
- 1 Amerchoke type 103, T5
- 1 Dubilier type 907 .25 mfd. condenser, C1
- 2 Dubilier type 907 2 mfd. condensers, C2
- 1 Electrad type B 25,000 ohm wirewound resistor, R1
- 1 Electrad type B 2,500 ohm wirewound resistor, R2
- 2 Durham Powerohm 5,000 ohm resistors, R3
- 1 Yaxley D.P.D.T. jack switch, S1
- 1 Electrad Royalty potentiometer 10,000 ohm, P1
- Magnetic pick-up.

smaller will be its sensitivity to weak (or distant) signals.

In view of these facts it was felt that since there is but a rather slight difference in building costs between a 171 and a 210 push-pull power amplifier it was decided to construct the 210 type because undistorted power output is fully



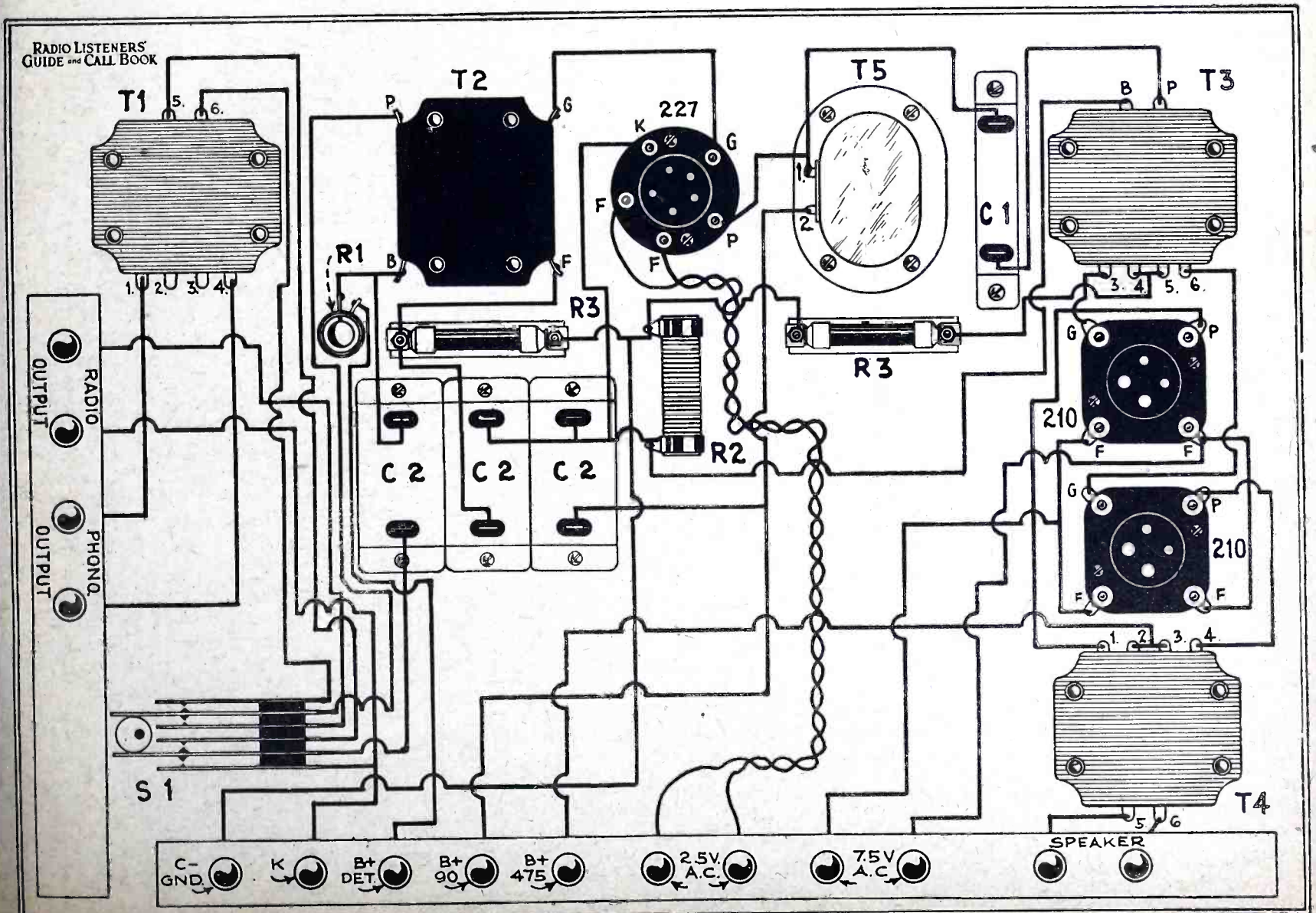


Schematic diagram of the power amplifier which has been designed for quality amplification.

feature, of course, is realized by use of high permeability alloy core materials. But through its use, as with Permalloy, one must be careful to keep the D.C. plate current circulating through this winding down to fairly low values (approximately 3 MA.) or preferably it should be eliminated altogether.

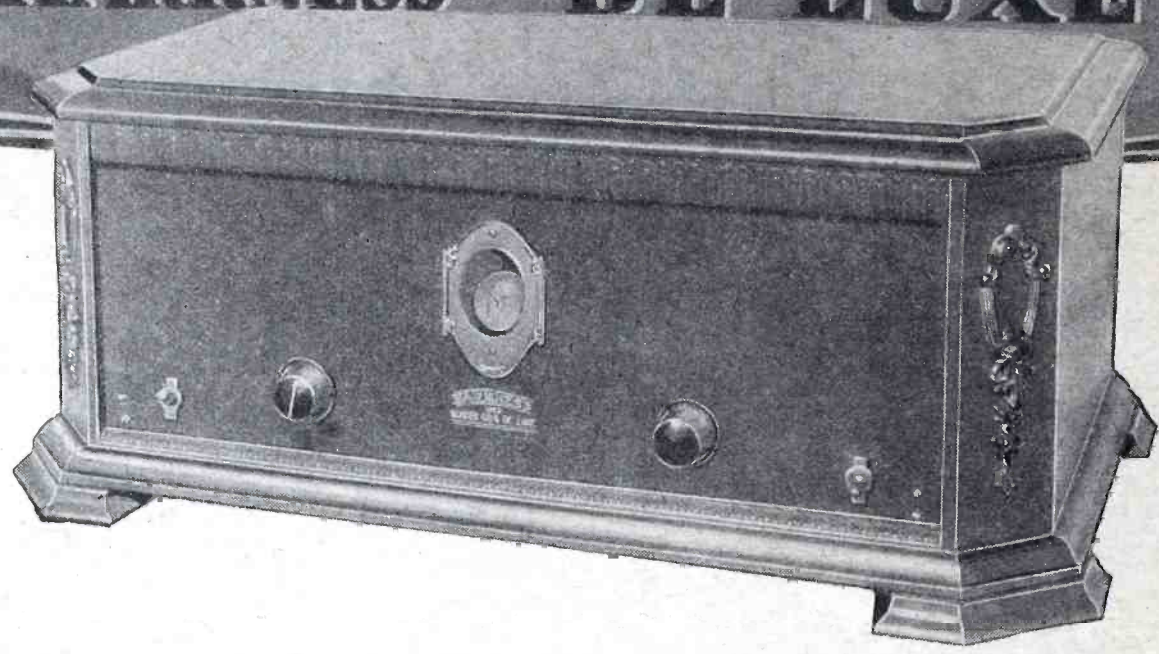
It was therefore decided to design the amplifier so that only the first or input Amertran unit would carry the D.C. plate circuit component of the detector tube, whereas plate current would be kept out entirely from the primary winding of the push-pull input transformer.

The latter scheme was accomplished by means of a choke, as specified, another apparently new device now available in the interest of high quality reproduction. Analysis of the circuit shows that in this stage the parallel feed plate supply sys-  
(Continued on page 137)



A wiring diagram of the amplifier in picture form is given in the illustration above.

# The HARKNESS "SCREEN GRID DE LUXE"



THE radio set-builder is in a very unusual and advantageous position today. The designers of receivers intended for the set-builder have made such rapid strides in the last few months that

it will take years for the set manufacturers to catch up with them. Right now the amateur or professional set-builder can assemble radio receivers which are years ahead of any factory-built set on the market.

To a certain extent the set-builder has always been in advance of the set manufacturer but he has never been so far ahead as he is today. There are literally scores of radio receivers now made available to the set-builder utilizing new principles which the set manufacturers will not incorporate into their receivers until a year from now.

One of the most important reasons for the rapid progress made by the designers of "kit-sets" is the development of the screen grid tube. This tube has actually revolutionized the design of radio receivers. Look through the pages of this magazine or any other radio magazine and you will find that practically every receiver designed within the past six months uses screen grid tubes. You will find very few factory-built sets using these new tubes. So far as we know, there is only one well-known set manufacturer using the screen grid tube.

Why have practically all the kit-set designers switched to screen-grid tubes? And why do the set manufacturers not use them? The answer to the latter question is easy; the manufacturers have not had time to change their designs and production schedules. Furthermore, it is only very recently that A.C. Screen Grid tubes have been developed and manufacturers naturally want to put out A.C. operated sets. You may rest assured, however, that manufactured sets will use screen grid tubes just as soon as the manufacturers can arrange to employ them. In the meantime, set-builders have the jump on the market.

The almost universal acceptance of the screen grid tube by designers of kit-sets can also be easily explained. This new tube is infinitely superior to the general purpose 201-A tube as a radio frequency amplifier. Two stages of screen grid amplification are more sensitive than three

or four stages of ordinary 201-A tubes. Furthermore, no "neutralizing" system is needed when screen grid tubes are used.

Consequently, the design and operation of receivers have been simplified and the cost of construction reduced. The fourth element of the new tube, known as the screen grid, neutralizes the

grid-plate capacity more effectively than any previous system of neutralization and at the same time enormously increases the amplification constant.

The advantages of this new tube were so obvious that almost every radio engineer in the country began to develop circuits and receivers with which the tubes could be efficiently used. Unfortunately, the first screen-grid receivers were not successful. The circuits used were not practical as the selectivity was very poor. The receivers proved so broad in tuning that set-builders became somewhat skeptical of the practicability of using the tube in t.r.f. circuits. In fact, most set designers have since devoted their time to the development of super-heterodynes for screen grid tubes.

However, this writer has always believed that most people cannot afford the high cost of a super-heterodyne and that the average set-builder prefers a simpler type of receiver. We believe that the screen grid tube would make it possible to design a simple, inexpensive tuned radio frequency receiver with a high degree of sensitivity and sharp selectivity. Experiments were conducted with this object in view. As a result, the "Harkness Screen Grid 5" was developed last year. This receiver solved the problem of obtaining sharp selectivity with screen grid tubes. It also provided a method of controlling oscillation in a screen grid receiver, a method which has since been widely imitated.

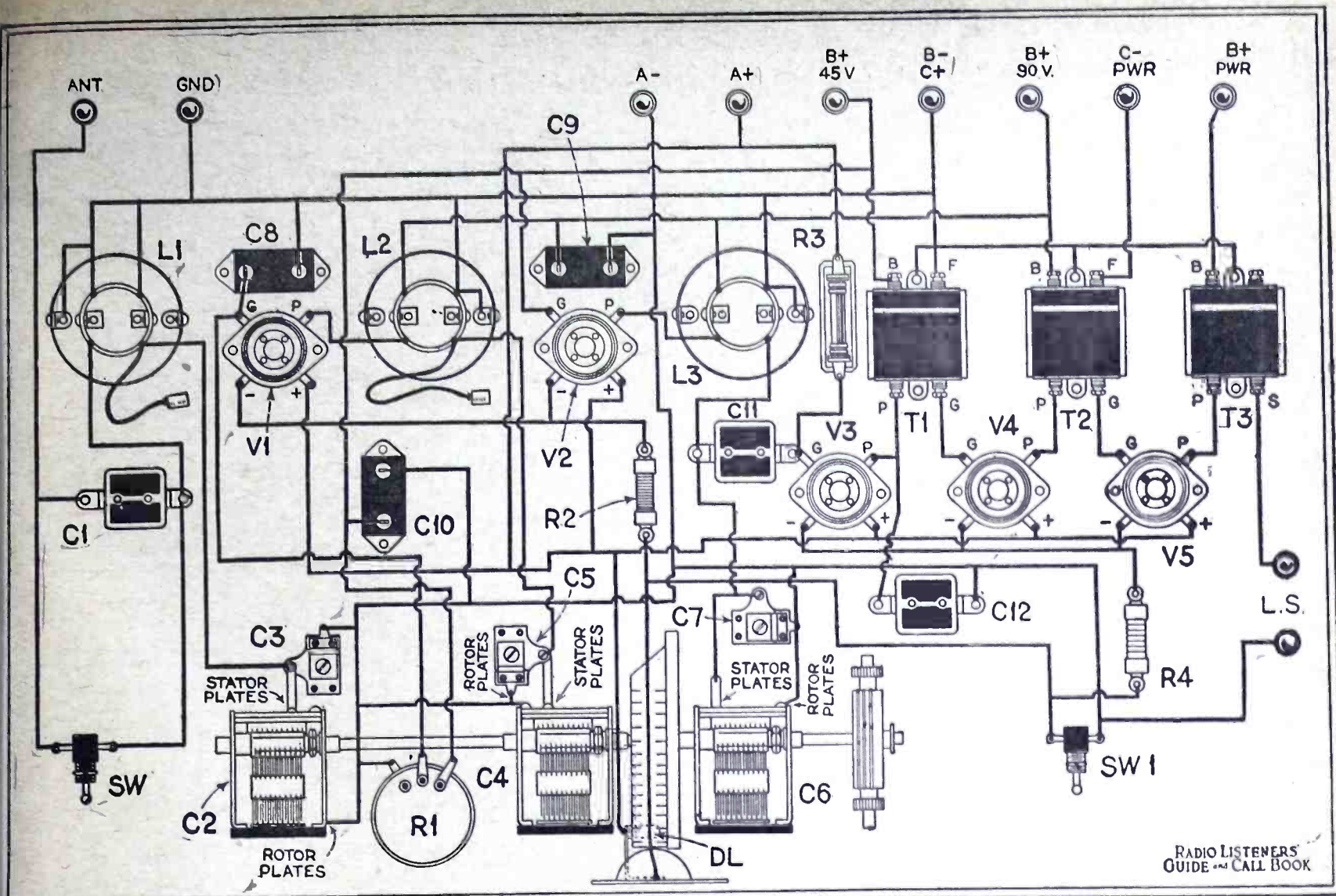
Some very wonderful results were obtained with this set and it proved to be one of the most popular and successful screen grid receivers of the season. Hundreds of them are now in use and are giving satisfaction to their owners. It was particularly popular in New York City where selectivity is essential. The set was so sensitive and selective that it tuned through locals in the most congested districts and brought in distant stations at almost any time in the evening.

Although this receiver was highly efficient the writer was not entirely satisfied. To bring in distant stations it was neces-

## LIST OF PARTS

- 1 Bakelite front panel, 7x21, drilled and engraved
- 1 Bakelite sub-panel, 7x20, drilled
- 1 Pair Harkness 1 in. sub-panel brackets
- 1 Harkness R.F. coil type SG-10, L1
- 2 Harkness R.F. coils type SG-50, L2, L3
- 3 Harkness aluminum coil shields
- 1 Harkness audio transformer type T-500, T1
- 1 Harkness double impedance audio coupler, T2
- 1 Harkness audio output filter unit, T3
- 3 U.S.L. .00035 mfd. variable condensers, C2, C4, C6
- 3 Hammarlund equalizers, C3, C5, C7
- 1 Hammarlund drum dial
- 3 Aerovox .5 mfd. condensers type 250, C8, C9, C10
- 3 Aerovox fixed condensers, .0001 mfd., .00025 mfd., and .001 mfd., C1, C11, C12
- 1 Aerovox grid leak mounting
- 1 Aerovox 2 meg. grid leak, R3
- 2 Saturn switches, SW
- 1 Centralab potentiometer, 500,000 ohms, R1
- 5 Eby UX tube sockets
- 9 Eby binding posts
- 2 Eby tip-jacks
- 2 Carter screen grid connectors
- 1 Carter 10 ohm resistance, R2
- 1 Carter 1 ohm resistance, R4
- 1 Special condenser ¼ in. shaft, 14 ins. long
- Misc. lugs, screws, panel supports, nuts, etc.

Previously it was necessary to neutralize the plate-grid capacity of each r.f. amplifying tube. This is no longer necessary.



This picture wiring diagram shows exactly how all parts of the set are connected.

RADIO LISTENERS' GUIDE AND CALL BOOK

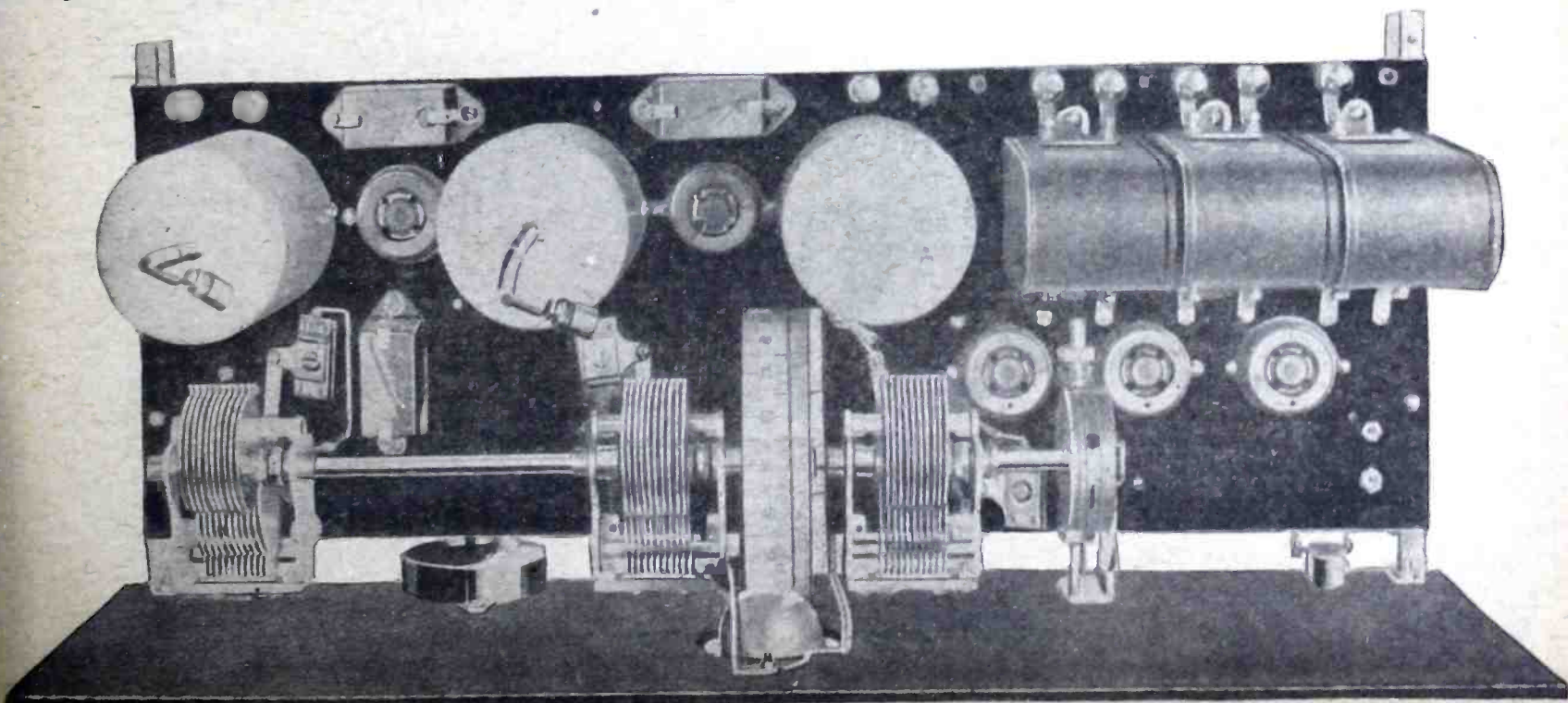
nary to utilize regeneration and this made the operation somewhat critical. Although oscillation was under absolute control I felt that it would be much better if oscillation could be entirely eliminated, providing this could be achieved without reducing the amplification. I also believed that the tone quality could be improved and that some mechanical features could be changed to advantage.

Accordingly, further experiments were conducted and, as a result, the Harkness "Screen Grid de Luxe" receiver has been developed. This new 5-tube set, illus-

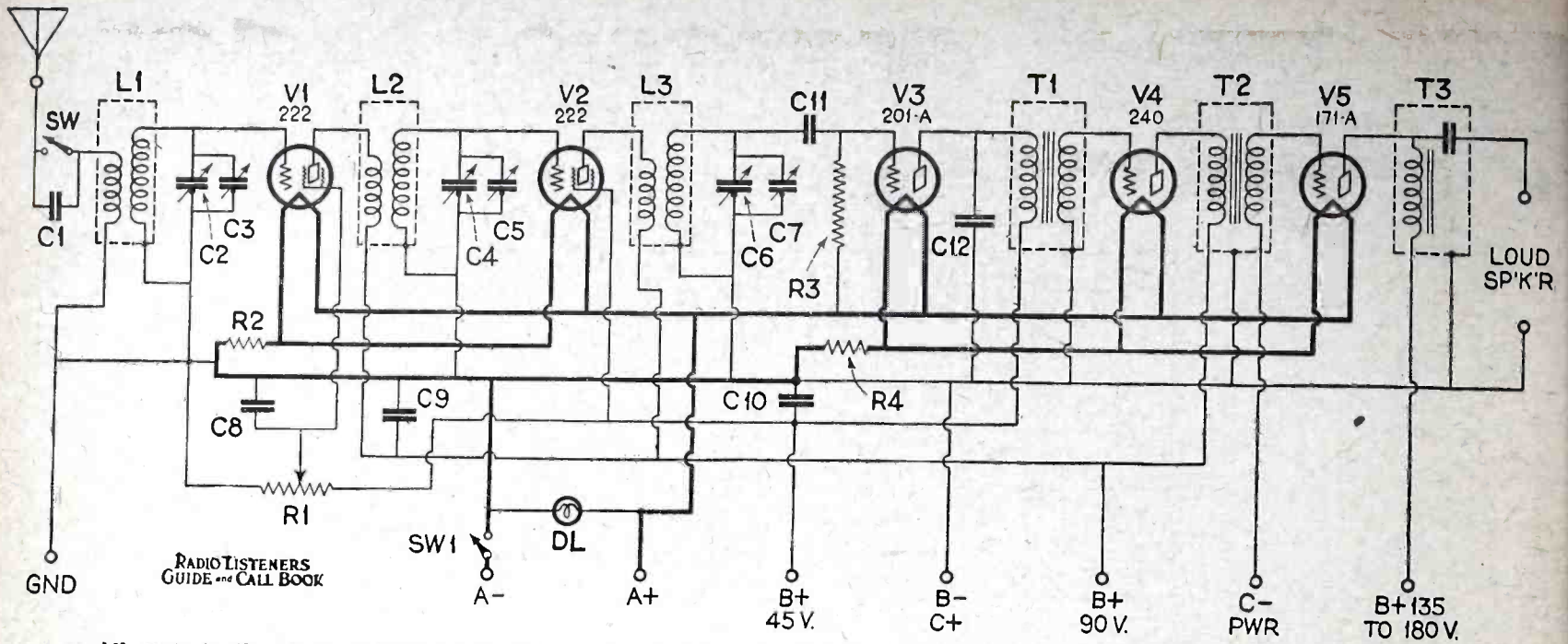
trated on these pages, retains the sharp selectivity which made the "Screen Grid 5" so popular. In addition, the sensitivity has been greatly increased and the tone quality considerably improved. Using normal operating voltages, oscillation has been completely eliminated. The set does not oscillate and the tuning is thereby made very simple and non-critical. A more sturdy and better type of volume control is used and a superior drum dial is employed. At the same time, the cost of construction has been kept down and the set can be built for practically the

same low cost as was last year's model.

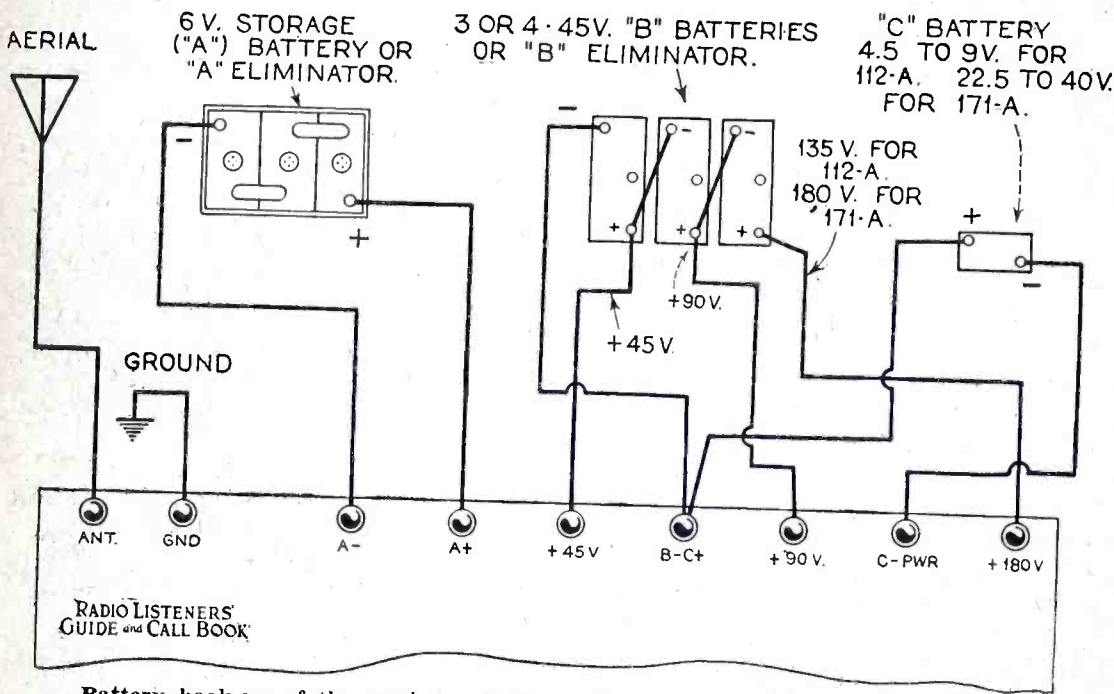
There are two models of the new "Screen Grid de Luxe." The one described in this article is the battery model and is intended for use with ordinary A and B batteries or with A and B eliminators. Standard 5 volt tubes are used. The other is the A.C. model, designed for Arcturus A.C. tubes throughout. The two sets are practically identical, the only difference being in the wiring. A special A-B-C power-pack has been designed for the A.C. model, supplying all the necessary power to the receiver. The power-



A top view of the Harkness "Screen Grid de Luxe" receiver. Follow the layout of parts as shown in this photo.



All parts in the above schematic wiring diagram are given in the list of parts and also indicated on the picture diagram.



Battery hook-up of the receiver. Battery eliminators can be used as indicated.

pack fits directly behind the set and both the receiver and power-pack can be enclosed in a standard cabinet, 12 inches

deep. The A.C. model is thus completely self-contained.

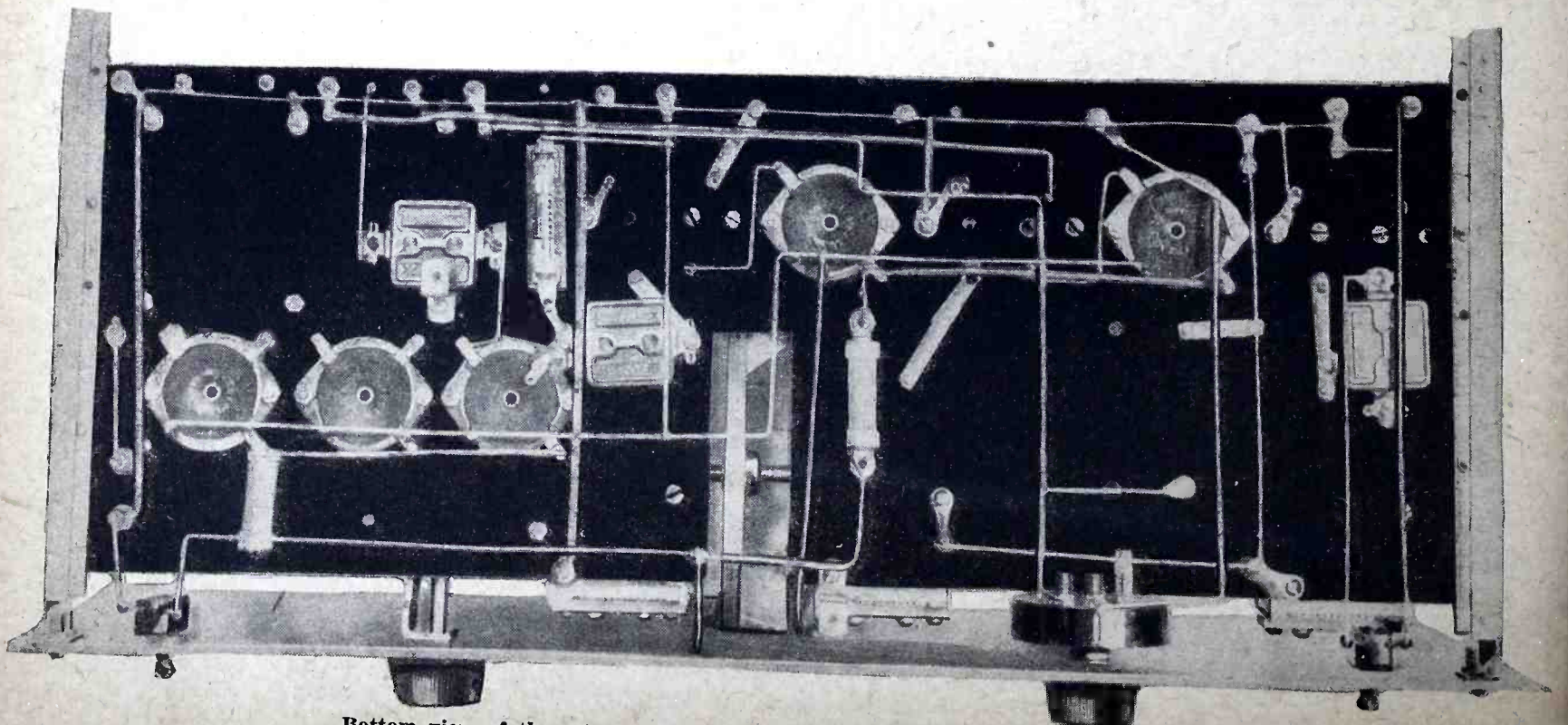
The results obtained with this receiver

have proved quite remarkable to all who have heard it in operation. In the writer's laboratory in New York City the "Screen Grid de Luxe" is permanently displayed and is operated every afternoon and evening for the benefit of local set-builders. Hundreds of these men, experienced in radio, have visited this laboratory and have heard the set cut right through local interference and tune in, with ease, distant stations all over the country.

The design of the radio frequency amplifier is responsible for the remarkable sensitivity and selectivity of this receiver. There are two stages of screen grid r.f. amplification and each stage is unusually efficient. This high sensitivity is obtained with a stable, non-oscillating circuit.

Oscillation was eliminated in a very simple manner. Our experiments proved that the oscillation of last year's model was caused by the use of a triple-gang tuning condenser. To wire this condenser into the circuit it was necessary to run fairly long grid leads from the stator

(Continued on page 135)



Bottom view of the set showing the connections to parts beneath the sub-panel.

# THE AERO CHRONOPHASE



**P**OPULAR demand has swung about during the past few seasons from the multi-tube receivers to more simplified models which, much easier to build and adjust, will accomplish as much and sometimes more than their more elaborate relations.

It may seem somewhat of a contradiction to say that five tubes will do the work of ten, and such a statement, if not modified in any way, surely would be incorrect. As a matter of fact, however, it very frequently happens that a good five or six tube set will accomplish more than many eight and ten tube outfits. Properly designed, two stages of tuned radio frequency will have sufficient amplification to reach the limit imposed by the noise level of even a clear winter evening, when static is at its lowest, and more than this adds nothing at all.

For the man who wants a receiver which will separate locals in even the congested locations like Chicago and New York, and at the same time, be able to get on occasion and under reasonably favorable circumstances, stations on either coast, the Chronophase receiver is ideal. Due to the advantages of the recently developed Chronophase system, unusual efficiency is obtained in consideration of the amplification of which the receiver is possible. The receiver is fully as selective as the usual 6 tube receiver and at the same time will under unusual conditions, receive signals from stations a 1,000 to 1,500 miles away with full loud speaker volume. One such receiver located in the middle of the Chicago swarm has been receiving Pacific coast stations nightly for several weeks at the time of writing and others have made a regular practice of such reception.

Most readers are concerned with the construction only and consequently we do not take the space to go into the theory of the circuit here but the course of experimentation which covered a period of nearly two months of intensive laboratory work, left no doubt that the final method developed, gave the optimum results not only with A.C. tubes but also with shield grid and standard D.C. tubes.

In a nut shell what is accomplished is a shift of the relative time of maximum voltage in each circuit making it possible to keep all of them working at full strength without having the receiver as a

local stations which have a tendency to "spread" as much as one hundred and fifty kilocycles on each side of the transmitter frequency. Inasmuch as the "Chronophase" receiver was being planned to secure distance, even though there was strong local interference, this particular phenomenon was of course not allowable and it was decided that a signal strength of one per cent of the full value was allowable fifty kilocycles on each side of the normal frequency. With a further experimental set-up entirely unshielded and with the coils separated by a distance of eight inches, it was found that this was secured by the use of two stages of radio frequency. This was done during actual reception condition, utilizing a two hundred foot aerial approximately fifty feet high.

Next came the question of audio frequency amplification. A transformer has recently been made available of a type hitherto used only in the especially constructed amplifiers which are placed in telephone lines used in transmitting broadcast programs for long distances over wires. To the average man who has trouble building a three stage audio amplifier without getting violent distortion, it would seem almost inconceivable that some of his chain programs may pass through many times that number of amplifier stages before being transformed into radio frequency curves and put on the air. The fact that no quality can be lost through this long chain of amplifiers is indicative of the need for almost perfect characteristics in the transformers and a special type was developed for that purpose, with a much flatter curve over the audible range than is ordinarily obtainable and continuing the flat portion of this curve out beyond the audible range so that there will be no loss of overtones and harmonics which, although themselves inaudible, will produce a decided effect upon the ear.

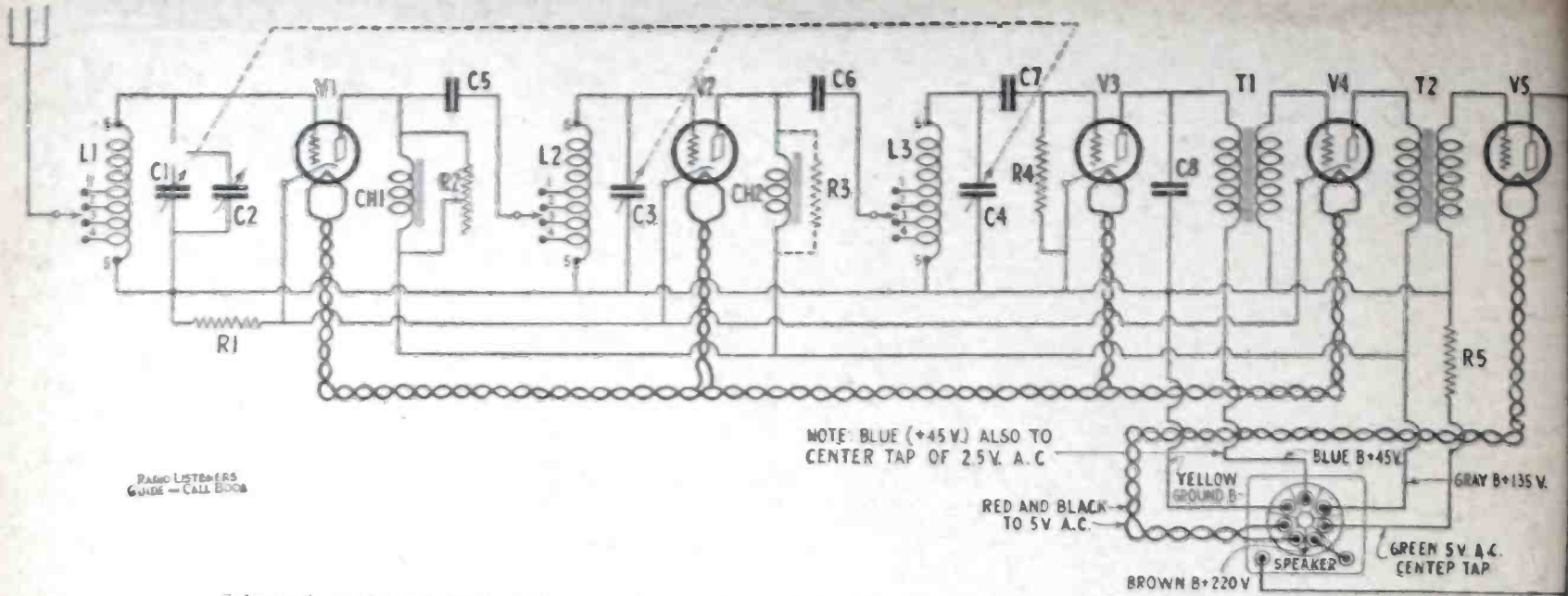
At the same time the transformer must have such a characteristic that as soon as a sound frequency is received, at which the overtones are no longer valuable, there will be a sharp cut-off so that at-

## LIST OF PARTS

- 1 Aero special 3-gang condenser, .00035 mfd., C1, C3, C4
- 1 Aero special precise midget condenser, C2
- 1 Aerovox moulded bakelite condenser, .00025 mfd., C7
- 3 Aerovox moulded condensers, .001 mfd., C5, C6, C8
- 1 Yaxley No. 660 cable connector
- 1 Yaxley No. 810 resistance, 10 ohms, R3 (optional)
- 1 Yaxley No. 7600 resistance, 600 ohms, R1
- 1 Yaxley No. 72000 resistance, 2,000 ohms, R5
- 2 Yaxley No. 422 tip jacks
- 1 Aero coil kit No. U-203, L1, L2, L3
- 2 Aero noskip choke coils No. C-60, CH1, CH2
- 1 National illuminated dial, Type E
- 3 Kurz-Kasch walnut knobs
- 2 Shield Grid Connectors, No. 342
- 2 Aero type AE-770 transformers, T1, T2
- 3 Eby binding posts
- 1 Allen-Bradley 3-megohm grid leak, R4
- 1 Aero special type AE-250 Centralab resistor, R2
- 1 Aero bushing for dial shaft
- 1 Roll Corwico Braidite hook-up wire.

whole break into oscillation. The nearest analogy is the well known example of an army crossing a bridge. A number of men marching in regular step across a bridge will build up vibration which will cause it to eventually fall, while a much larger number of men can cross the same bridge if they break step without causing any danger whatsoever.

The most bothersome type of station interference appears to have been experienced from the signals of very strong



Schematic wiring diagram of the Aero Chronophone. Note that the 5-volt A.C. heater leads are twisted.

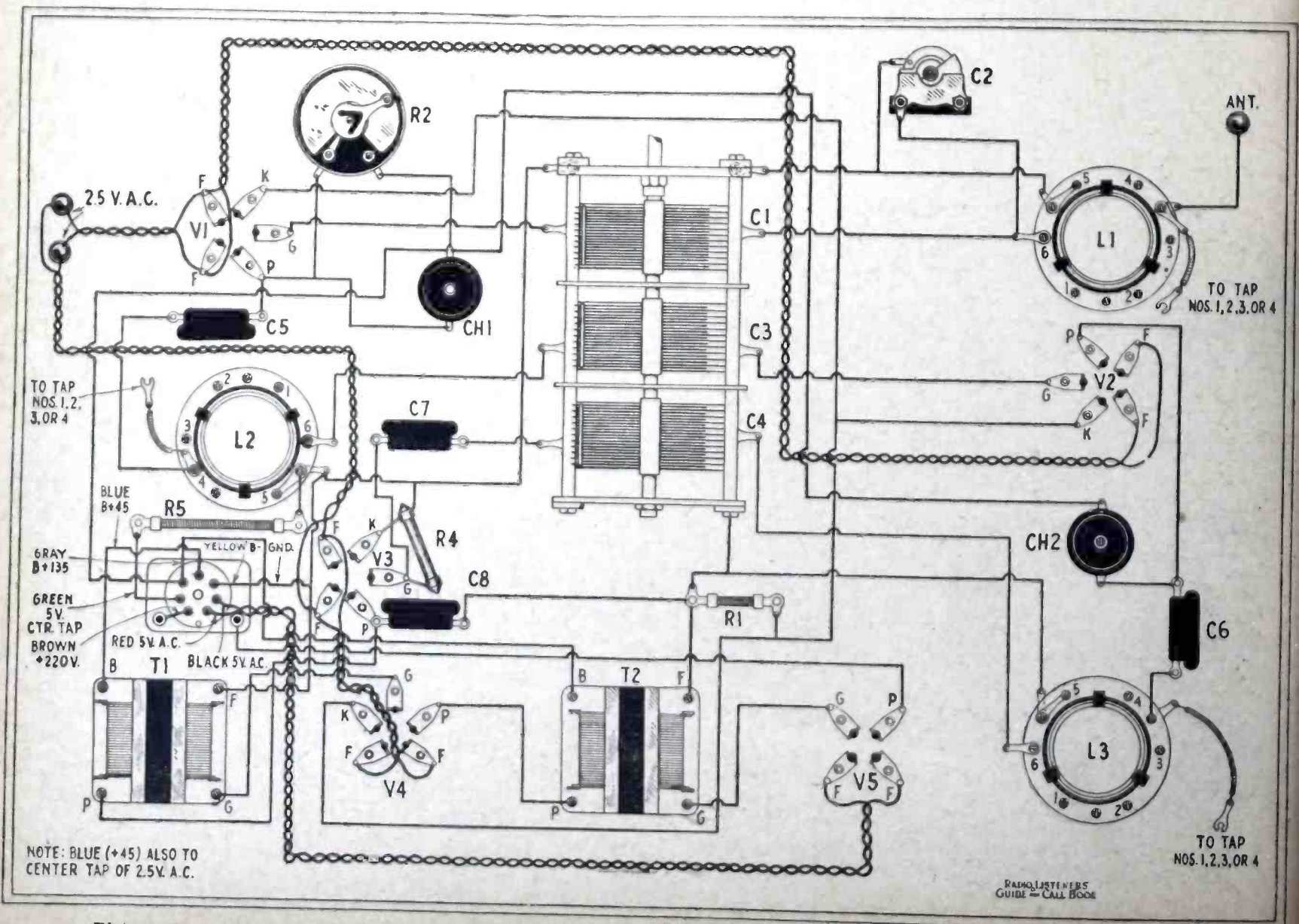
mospherics, tube noises and other electrical disturbances which produce the effect often heard as a "needle scratch" in a phonograph will not be passed through.

Having both the audio frequency and radio frequency amplifiers determined, it was now only necessary to lay out the receiver in such a way that no serious losses would result from troubles in the layout and construction.

Always presuming that the coils and condensers of a radio frequency amplifier are of the best quality obtainable, one

of the most prolific sources of difficulty has been found to be in superfluous length of leads, particularly in the grid circuits where the maximum energy is desired and the impulses are most readily vulnerable. The plate leads come next in sensitivity to external influences. In order to keep these both as short as possible, the arrangement of parts indicated in the illustration was employed. It will be noticed that stators of the condensers, which must perforce be in the grid circuit anyway, are used as grid leads, allowing the placing of each tube very

close to the subsequent radio frequency transformer, and permitting extremely short leads in both instances. A triple condenser with arrangement for compensating any slight differences in capacity, it used to tune the amplifier. The means provided for synchronizing the sections of the condenser proved to be insufficient to properly compensate for antenna variations and since with some antennas, an adjustment will be required between the high and low frequency ends of the broadcast band, it was deemed advisable to put a midget condenser, used



Picture diagram of the set. All parts are indicated to correspond with list of parts, layout and schematic diagram.

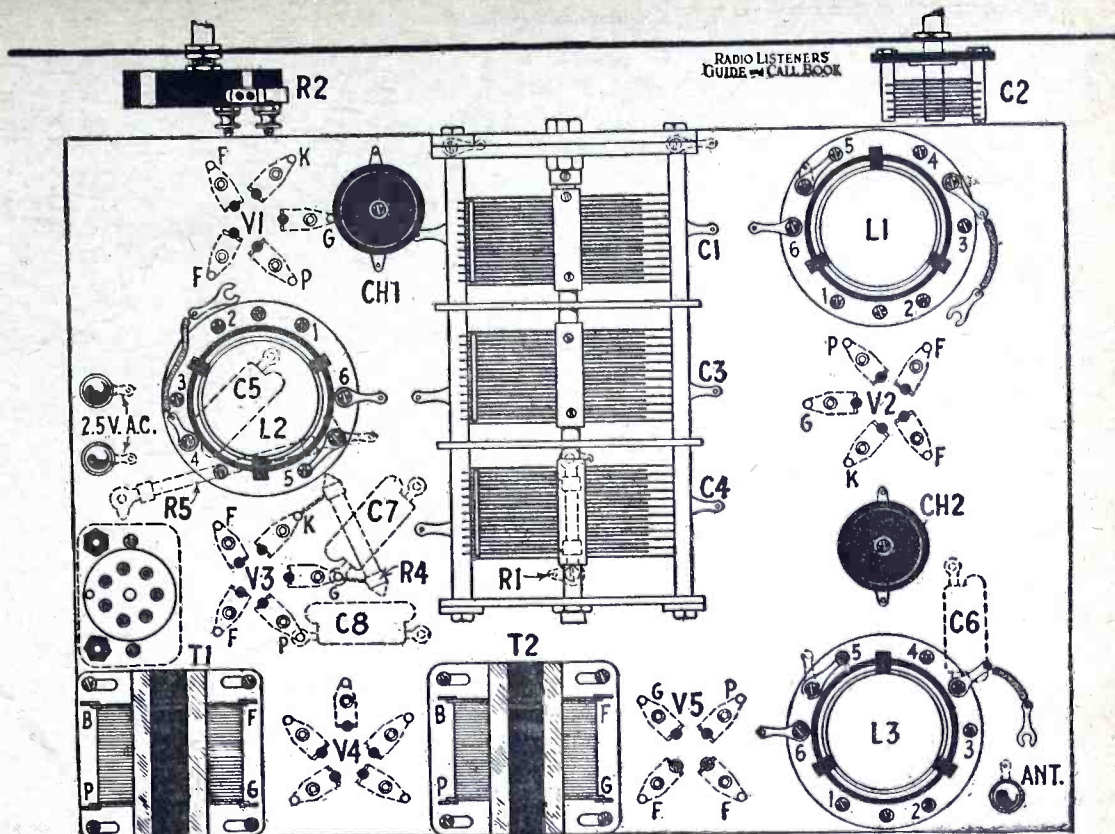
as a vernier for the first stage, on the panel.

The illustrations show the complete layout finally adopted in the receiver. The Central Radio Laboratories manufacture a special variable resistance for the stabilizing control which is absolutely stepless, and can be adjusted to hair-line capacity. The Allen Bradley grid leaks used are built from a solid block of carbon. This is non-hydroscopic and is hence totally unaffected by weather changes, making it possible to solder it promptly into place without using the ordinary grid leak clips which are a fertile source of trouble, due to oxidized connections and consequent poor connections and noisy operation.

The fixed condensers were also selected with great care, since their use in the "Chronophase" system is in a position where too great a phase angle difference in the condenser di-electric would seriously affect the operation of the circuit.

An inspection of the illustrations will show that there are practically no connections on the top of the sub-panel other than those running from the stators of the variable condensers to the No. 6 terminals on the coils. The coils are mounted by three machine screws and the .001 mfd. condensers between the plates of the tubes and the taps on coils are connected to the mounting screw between terminals 3 and 4 on the underside of the panel. A piece of flexible wire is attached to the top of the same screw, the other end of which can then be connected to whichever terminal of the coil gives the desired results as will be explained later.

After making these connections, wire up the filament circuit, twisting the leads into a cable which more or less follows the outside lines of the sides and back of the panel. Then hook-up the balance

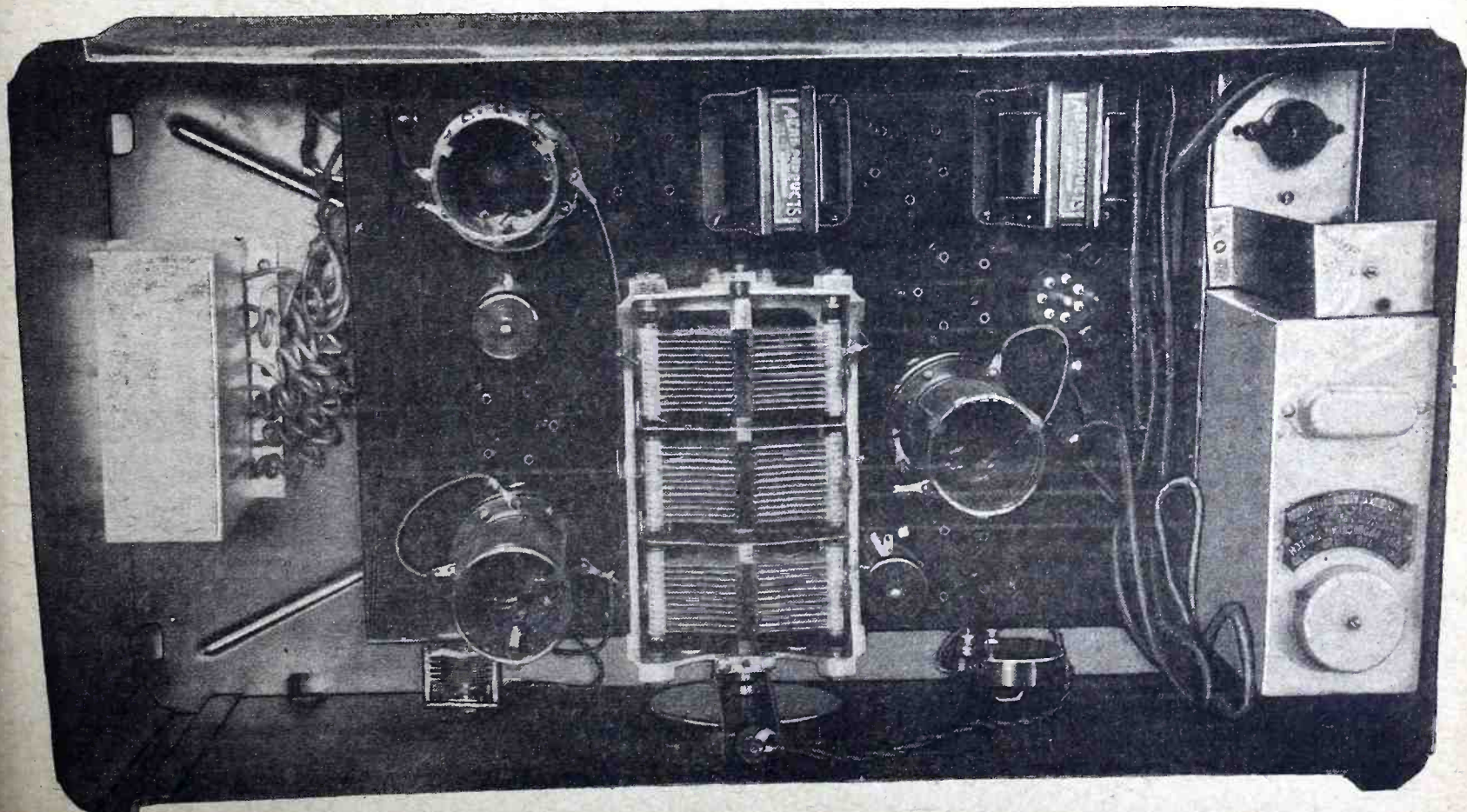


Layout of the parts on the sub-panel. Dotted parts are beneath.

of the connections, making the connections to the audio transformers through the small holes just alongside of the holes for mounting the transformers, with flexible wires. All filament, B plus, and C minus wires can be twisted into the cable wherever convenient, but the plate and grid leads should always be kept free, with the exception of the output lead which can be cabled with everything else.

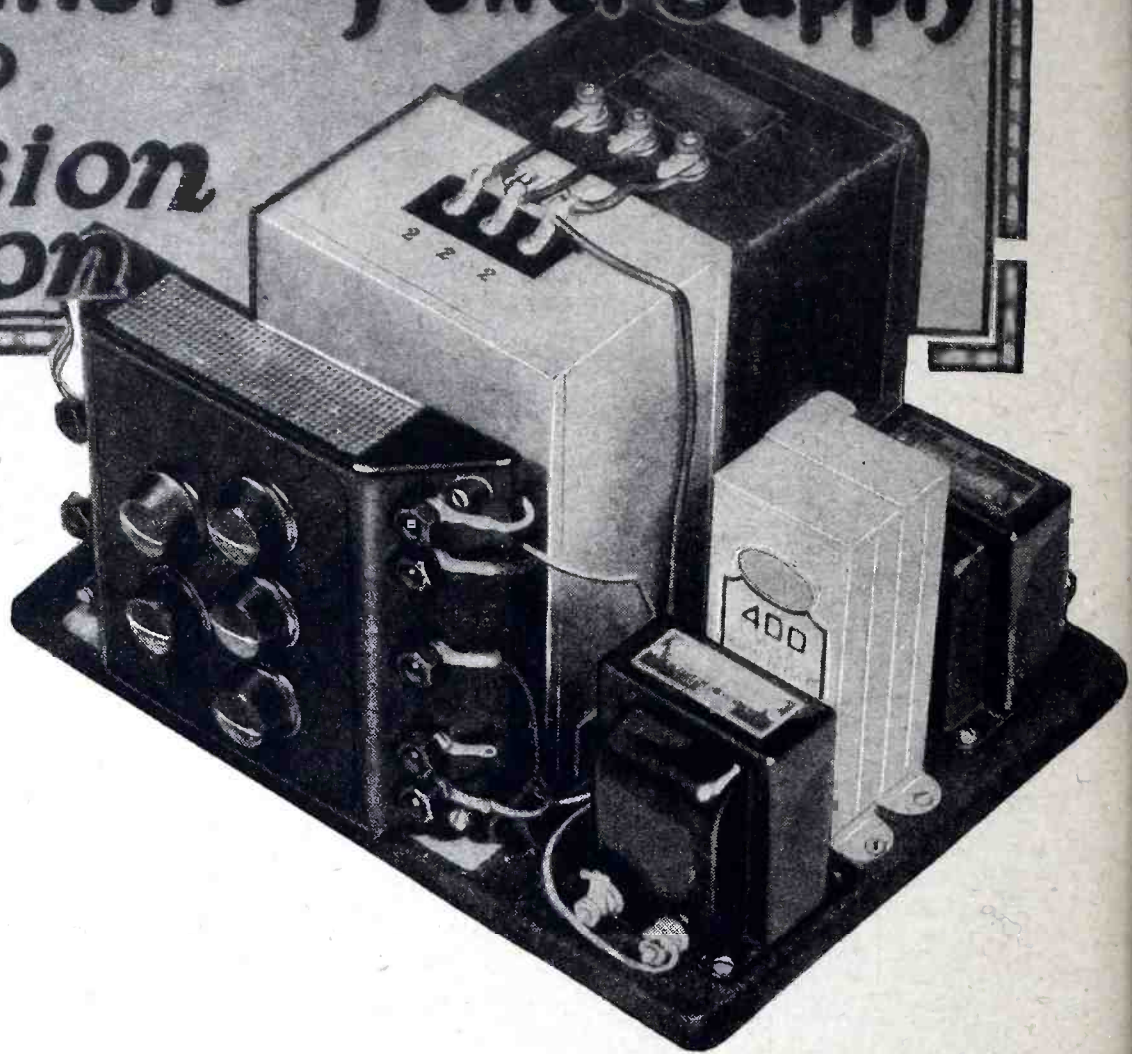
In constructing the A.C. model, follow the same procedure except that the filament leads to the heaters of the 227 tubes should be twisted and made of fairly heavy wire. The terminals for these two leads are brought to two bind-

ing posts mounted on the sub-panel. The lead from these binding posts to the filament transformer should be kept comparatively short and if the Aero filament transformer is employed, it can be inserted in the cabinet alongside the set. In the A.C. set all necessary biases or "C" battery voltages are obtained directly from the "B" current and when a "B" eliminator is used with the A.C. model, the minus-B connection can be ignored. Connect the minus-C of the eliminator to the minus-B (yellow) terminal of the cable connector and do not connect the minus-B on the eliminator to anything.



Looking down into the set. The condenser block at the left and Radiart power unit at the right is the same as that used in the "Aero Metropolitan Four," also described in this issue.

# An Amplifier and Power Supply for Television Reception



WITH the increasing interest displayed in the subject of television the question as to what is a suitable type of amplifier for use at the receiving end, will naturally arise. Amplifiers for television work have been frequently discussed in scientific circles but little constructional knowledge has as yet been available to the fan.

Amplifiers for television work suitable for use in the home must conform to a few rigid requirements, among which are, simplicity and low cost of construction and operation—extreme efficiency, and adaptability to existing receivers. The word "efficiency" covers many individual aspects encountered in the design and functioning of an amplifier for television reception. Incidentally the word "television" in this respect is somewhat of a misnomer. Frankly we mean radio-vision, since radio is the medium by which

## PARTS FOR POWER SUPPLY

- 1 Thordarson 210 power compact, T
- 1 Thordarson 211 steel baseboard
- 2 Thordarson R-196 chokes, CH1, CH2
- 1 Tobe 210 condenser, C1, C2, C3, C6, C7, C8
- 2 Tobe 400-volt, 2-mfd. condensers, C4, C5
- 1 Electrad Truvolt Divider, R1
- 1 Electrad Truvolt multiplier, R2.

the projected pictures are to be transmitted.

With the broadcasting and television methods of transmitting commonly employed today, an amplifier covering and amplifying a fairly wide band of frequencies is necessary. The exact band of frequencies necessary concomitant with a given method of transmission will be discussed later. It is the purpose of this article to discuss not so much the methods of television in use today or the design of the apparatus to accomplish that result, but to give the radio fan some information on the construction of an amplifier and power supply device which can be hooked on to his radio receiver and which will be capable of reproducing pictures at the receiving end in as good a definition as they are put on the air.

Radio vision, to say the least, is an art

yet in its infancy. The radio fan who builds equipment in order to receive the broadcast scenes of action must not be in the least discouraged when, after installing the apparatus he finds that extremely clear definition cannot be obtained. It is useless at present to expect to see the image of a man, which will show the whites of his eyes so to speak, or other such fine details as is possible in the transmission of still pictures by one of the many systems in use today.

The transmission of pictures employing action necessitates the use of a very wide band of frequencies in order to obtain detail such as is expressed in an ordinary photograph. At the present time, results of a highly satisfactory nature can be obtained by the use of suitable equipment. The reception of active pictures of a nature which we might term "a shadow silhouette" can be easily and cheaply accomplished.

It would, perhaps, be advisable before describing the apparatus in question, to give a short outline as to what is going on at the transmitting end and why it is necessary to use an amplifier capable of covering a wide band of frequencies and also what factors go to govern the band of frequencies involved.

At the transmitting end the "subject," that is the person or moving object of which it is desired to transmit a picture, is "scanned" by one means or another, the most accepted method of scanning being performed by a rapidly rotating disc, around which is a series of holes at frequent and even intervals, which gradu-

ally move across in predetermined regular lines so that the subject is entirely covered by the holes. This method has been dealt with quite thoroughly in RADIO LISTENERS' GUIDE & CALLBOOK and magazines and it is deemed not necessary to go

## PARTS FOR AMPLIFIER

- 4 Amsco RC-2 resistor couplers with condensers, C1, C2, C3, C4
- 2 Durham metallized resistors, .05 ohms, R5, R7
- 2 Durham metallized resistors, .1 ohms, R1, R8
- 1 Durham metallized resistor, 1 ohms, R2
- 1 Durham metallized resistor, .2 ohms, R3
- 1 Durham metallized resistor, .5 ohms, R4
- 1 Durham metallized resistor, .25 ohms, R6
- 2 Thordarson R-196 chokes, CH1, CH2
- 1 Frost 6-ohm rheostat, R9
- 1 Frost 2,000-ohm potentiometer, R12
- 14 X.L. push posts
- 4 Benjamin tube sockets
- 1 Tobe .01 mica condenser, C5.

too deeply into this subject here. However, whatever method of scanning is utilized it is necessary that the subject be covered in its entirety in one sixteenth (1-16th) of a second or less. This speed is necessary in order to deceive the eye, and repeats what we recognize as a mov-



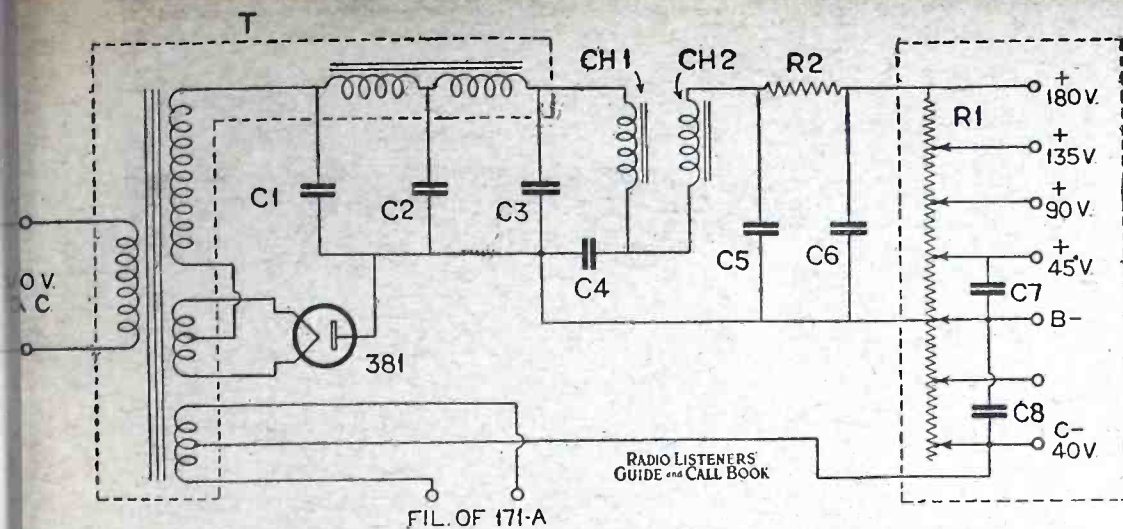
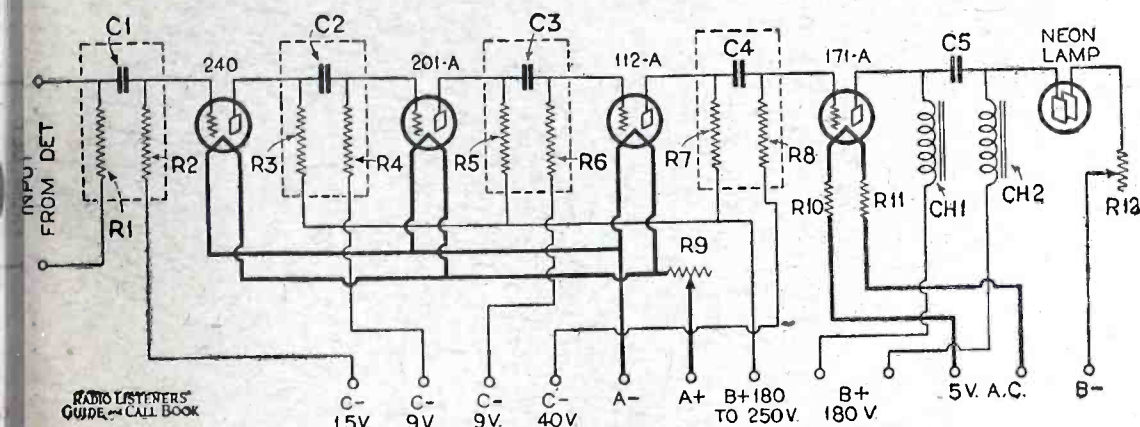


Diagram of the power supply unit designed for use with the resistance coupled television amplifier described herewith.



Wiring diagram of a resistance coupled amplifier for television. This hook-up operates exceptionally efficient in conjunction with the power supply given in the above diagram.

resistor in the plate circuit of the detector tube. This condenser should be kept as small as is commensurate with satisfactory operation of the amplifier, since such a condenser will tend to cut off the higher frequencies to a pronounced degree.

The use of "B" eliminators on resistance coupling for radiovision work have produced the most discouraging results, but by the use of a real good rectifier system and a highly efficient filter, the rectified alternating current supply can be satisfactorily used at the receiving end. Ordinary "B" eliminators, however, are not suitable unless they are equipped with a filter designed for the purpose.

The power amplifier combination shown in the accompanying diagrams has been satisfactorily used on existing radio receivers. It will be noted that the output of the rectifier system undergoes two additional stages of filtering. This is necessary to ensure an absolutely silent power supply. Any noise from the "A" or "B" supply of such a system will produce what is known as "dirt" in the reproduction of the picture. This "dirt" effect is less pronounced in the reception of radio pictures than in stationary pictures transmitted by land wires.

Referring to the accompanying diagram it will be seen that the output of the detector tube is passed through four stages of resistance coupled amplification, the first tube of which is a high mu tube, followed by an ordinary low mu tube of the CX-301A type which is again followed by two power tubes of the 112-171 type. This seemingly unorthodox sequence of tubes is necessary to eliminate distortion as far as possible by virtue of the fact that each following tube is designed to accept at its grid circuit the in-

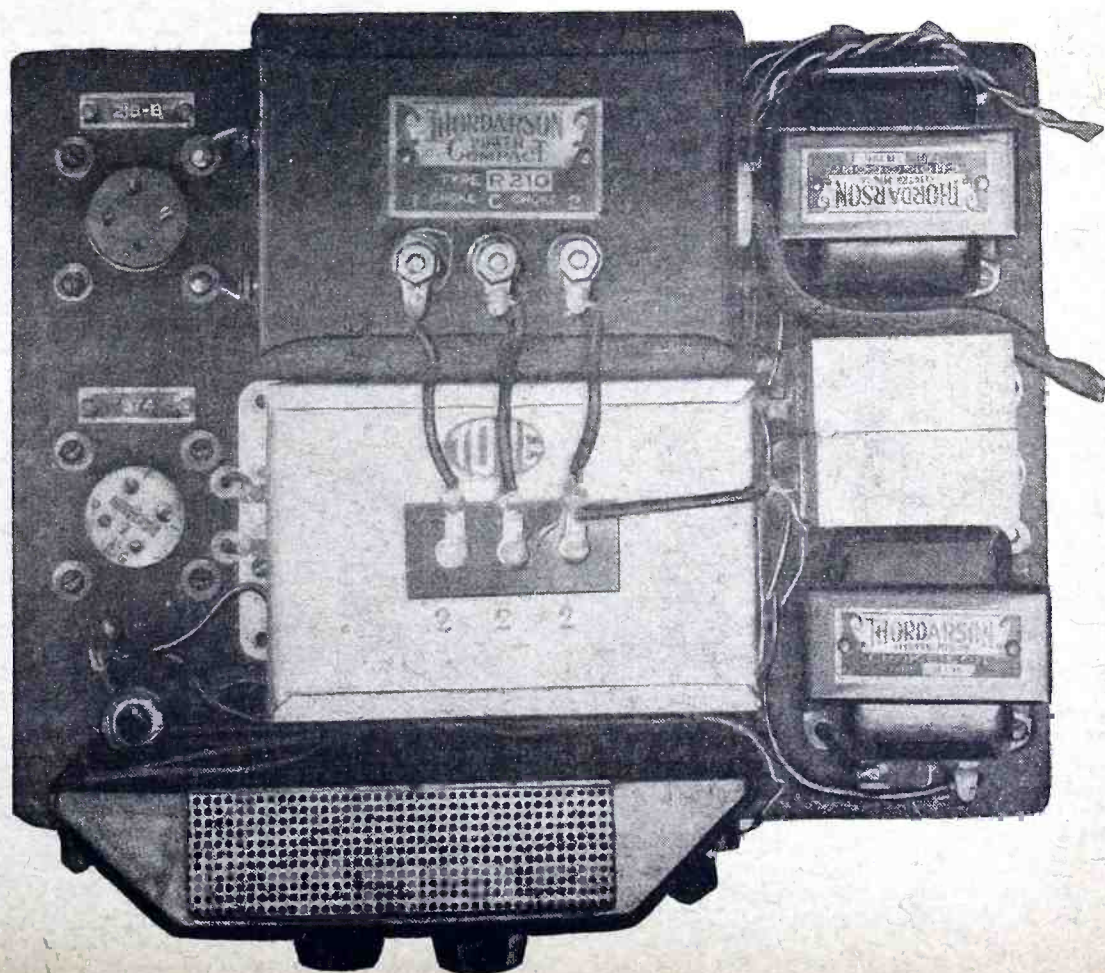
(Continued on page 142)

ng picture. Some methods of scanning employ an interrupter whereby the picture is divided up into a series of dots or mesh, while others just divide the subject up into lines. It has been found that dividing a picture of about 1½ inches square into 50 lines strikes the happy medium for present day transmission purposes.

Now the picture is divided up into approximately 50 lines across each dimension, making a total of 2500 exposures. This means that the equivalent of 2500 exposures have to take place in the short period of time of 1-16th of one second. Since the picture is completely scanned 16 times in one second this necessitates a frequency band of 40,000 cycles, which means that not only must the audio frequency amplifier in the receiver be capable of covering this wide band of frequencies, but the transmitter must also function in the same manner. The amplifier, however, need not necessarily have a uniform characteristic below about 500 cycles per second, in fact, if the amplifier has a uniform characteristic between frequencies of 800 and 20,000 cycles per second, quite good results can be obtained.

With the present available methods of amplification it would seem that there is only one method of amplifying such a wide band of frequencies efficiently, this method being the well known resistance-capacity coupling. Resistance coupled amplifiers for use in radio broadcast reception have met with wonderful success, and the same style of amplifier is rapidly finding its place in the field of radio and television. A resistance coupled amplifier for radio re-

ception of moving pictures must be operated within some very stringent limits, otherwise the most disappointing results are liable to be encountered. The use of by-pass condensers across any of the resistors should be shunned like poison, although it is sometimes necessary to connect a small condenser across the input



Assembly of the power unit for television reception.

# Electrifying the Battery Set with the Knapp "A" Power Unit

**I**N the mind of the average radio set owner an electric set is nothing more or less than radio which operates directly from a lamp socket. It is a simple and homely definition, but this type of apparatus, plus a cabinet having good eye-value practically makes

up the entire specification. The apparatus proper, or that which is "under the cover" is just some form of scientific development—how or what makes it work is of minor importance. A periodical overhauling such as the replacement of tubes, or repair of a loose connection and the like, is about all the attention a modern radio set should require.

Of course the actual construction and operation of present day radio receivers employing vacuum tubes is far more complicated than this simple analogy would lead us to believe.

In modern radio sets it will be found that the vacuum tubes required for picking up the minute radio frequency signals from a distant broadcaster, the detection or rectification of this radio frequency energy, and finally the amplification of its audio components makes it essential that the vacuum tubes in the several positions be operated by the application of the following voltages in addition to the incoming signals:

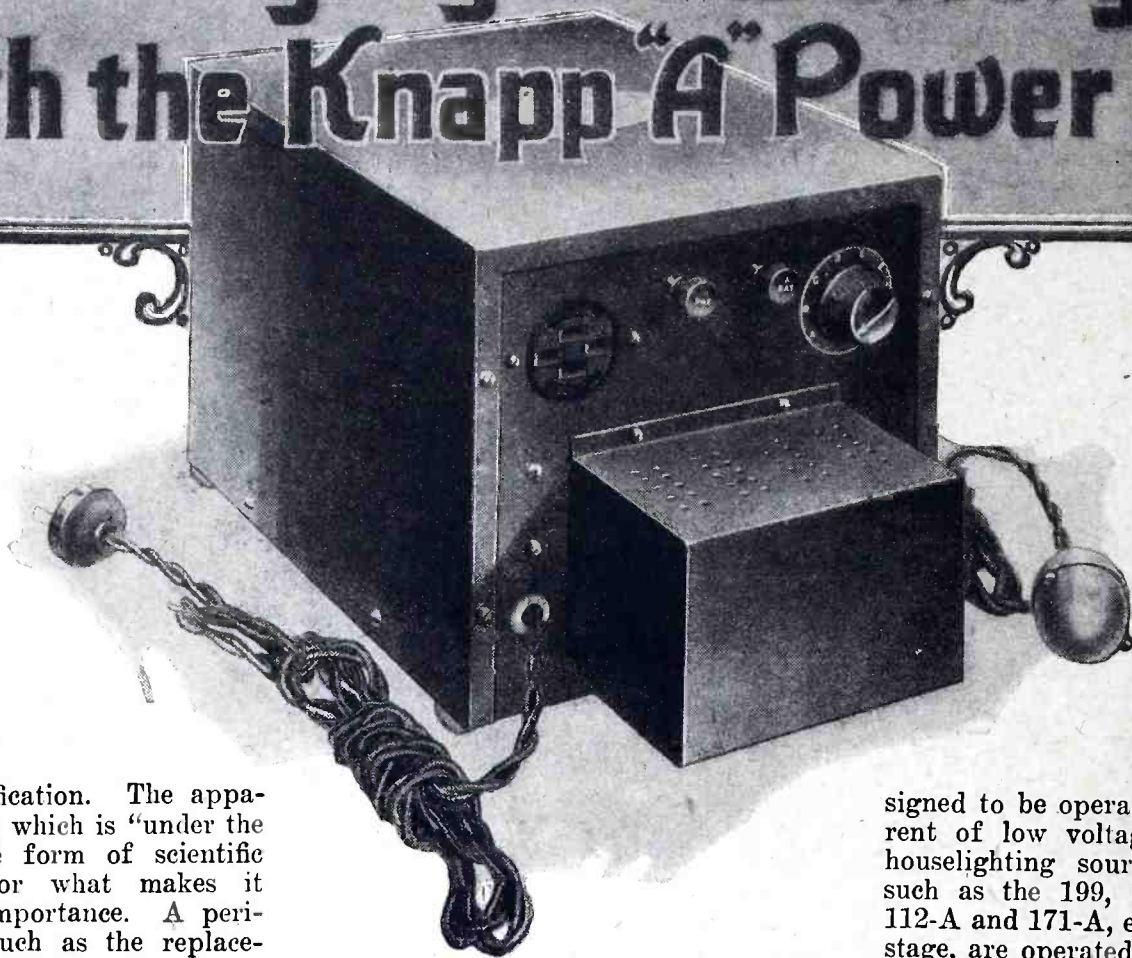
(1) A direct current source for the plate supply system

(2) A steady voltage (D.C.) for biasing the tube grid circuits

(3) A direct or alternating current supply for heating tube filaments.

It is with regard to the last mentioned item that we find the real bone of contention—why the average set owner calls any receiver an electrified set just so long as no batteries are employed. Hereafter in this article it shall be assumed that in all cases some form of rectifier system or socket-power device is being used in supplying the plate and grid D.C. circuits of all tubes.

And from this, as most everybody understands, it was the storage battery used in energizing tube filaments which constantly gave trouble by either (1) becoming discharged at the wrong time, (2)



tubes function in very nearly like manner, but the real difference is found in the method of energizing or heating their filaments. Receivers employing tubes of the CX-326-UX-226, and CX-327-UX-227 class have filament structures which are especially de-

signed to be operated at alternating current of low voltages as supplied from house-lighting sources. All other tubes such as the 199, 120, 201-A, 222, 240, 112-A and 171-A, except in the last audio stage, are operated from a direct current supply. For this purpose a storage battery was formerly about the only available supply.

Like most other things, A.C. filament type tubes have their good and bad points. Of course any device which depends merely upon an initial power supply furnished by large central stations naturally limits to a small degree the possibility of failure in service.

It is dubious if the present model A.C. tube is the ultimate. The development of the A.C. tube of today was a lengthy and expensive undertaking. As a result, the initial cost of the A.C. tube is two or three times the cost of the D.C. tube.

The introduction of the A.C. tube necessitates alterations in the wiring diagram and the use of special equipment required to supply the power and control. Auxiliary devices are required to protect tube filament life, since the source of filament potential, is constantly fluctuating. The lack of such control devices or their incorrect use, hastens the premature demise of the A.C. tube filament, thus making its operating life in comparison with the D.C. tube, much shorter. Manual control of such voltage control devices is quite difficult, and omission of the device invariably decreases the life of the tube.

The design of the A.C. tube differs radically from that of the D.C. tube. Particular reference is being made to the filament circuit, since we are concerned with this part of the receiver installation. The introduction of the oxide coated filament introduced factors which influence the vacuum within the tube.

The truth of these arguments can best be appreciated by glancing over the

failing to hold a charge or (3) requiring water. This latter, in addition to the acid odor caused by filling, was in itself a sloppy job—frequently the cause of ruined rugs and perhaps the radio cabinet itself.

Most storage battery chargers, while being fairly efficient devices, also contrib-

## LIST OF PARTS

- 1 Knapp power transformer, A
- 2 Knapp choke coils, L1, L2
- 3 Knapp special high capacity "A" power condensers, C1, C2, C3
- 1 Knapp rectifier unit, R
- 1 Knapp A.C. line attachment cord, X
- 1 Bakelite front panel
- 1 Knapp base plate
- 1 Knapp special 8 point switch, knob and plate, SW
- 1 Knapp receptacle for "B" eliminator
- 1 Knapp pendant switch and cord
- 1 Bakelite connector strip, screws, nuts and bushings
- 2 Output Binding Posts
- 1 Standard attachment plug and cap
- 1 Roll Corwico Braidite hook-up wire
- Box covers, rubber bushings and miscellaneous hardware.

uted their share of trouble. Here was simply another auxiliary affair which, like the storage battery was acid filled and required watering. In addition to this, certain type never stayed in adjustment, while in others the rectifier tube burned out. All things considered, the charging of batteries was seldom an automatic and entirely satisfactory operation. From the foregoing we learn that the grid and plate circuits of all receiving

Question and Answer columns of radio magazines and newspaper sections. Radio dealers and servicemen alike generally come to the same conclusions.

In order to realize full receiver electrification (operating the filaments from a central station source via the lamp socket) in much the same way as for A.C. filament tubes, the identical degree of simplicity can be had by those using D.C. tubes of the 199, 120, 222, 240, 201-A, 112-A, 171-A, etc.

The method described in the following consists merely of a high current low voltage rectifier system, with a potential dividing and filter network. This arrangement converts our houselighting al-

The various parts of the new Knapp "A" Power Device may be purchased on the open market. For those not mechanically inclined, it is believed such a unit can also be obtained in finished forms. Instructions for assembling the parts are as follows:

For a successful job, let us "make haste slowly" and build up the device in several logical stages. As a result of experience it was found that by dividing the work into three main assembly units little trouble or loss of time will be experienced.

The base plate, which is die cast, has all of the necessary holes for mounting the chokes, transformer, condenser brackets, front panel and steel box body.

to the rear lugs of the base plate.

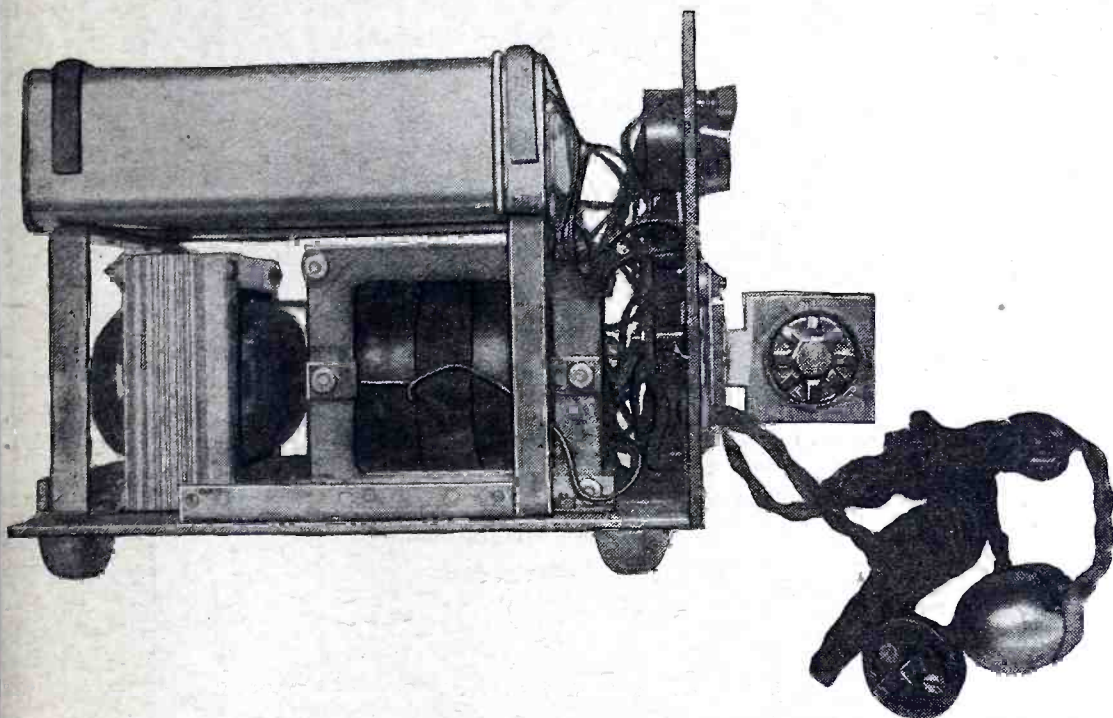
The front panel which is made of bakelite, is provided completely drilled and tapped. First of all mount the "B" eliminator receptacle, together with its two mounting screws. The receptacle is placed in the large hole provided for it in the upper left hand corner of the panel. The screw heads are on the outside panel front, passing into the tapped holes of the receptacle lugs. Now insert the rubber bushings, into the provided holes in the lower part of the panel. These bushings cushion the pendant switchcord and the A.C. line attachment cord from the panel.

The special eight point switch, SW, is next mounted at the upper right-hand corner of the panel as shown in photo. A 7/16 inch hole is provided in the panel for this switch, which should be mounted with its center arm soldering terminal lug towards the bottom. Pass the bushing through the 7/16 in. hole; put on the red indicating plate and fasten down with special nut. The indicating plate should be in such a position that the letters are vertical, as indicated. The knob may then be assembled. The knob arrow-head should be turned so as to indicate "H", and then the set-screw may be made up fast.

The "A" plus and "A" minus (D.C. output) binding posts are next mounted on the panel. The positive post must be on the right side, as shown in photo of the assembled unit.

Now fasten the bakelite connector strip, to the rear of the panel in a vertical position under the "B" eliminator receptacle. This connector strip is mounted with the lugs facing away from the panel. Mounting screws pass through the latter and just above the left-hand rubber bushing. After the strip is in place, put on and tighten nuts to hold the strip securely in place.

The next step is to assemble the rectified unit mounting contacts. For these, five holes are provided in the panel; three in a row in the center and two in a row at the bottom. In mounting the contacts proceed as follows:—Place an 8-32 nut at the end of each stud so that its end will be flush with the nut surface; then screw on the brass collar, leaving 1/8 inch space between the nut and collar. Place studs through proper holes in panel, with contact collars flush with panel front. Place both a flat and lock washer behind



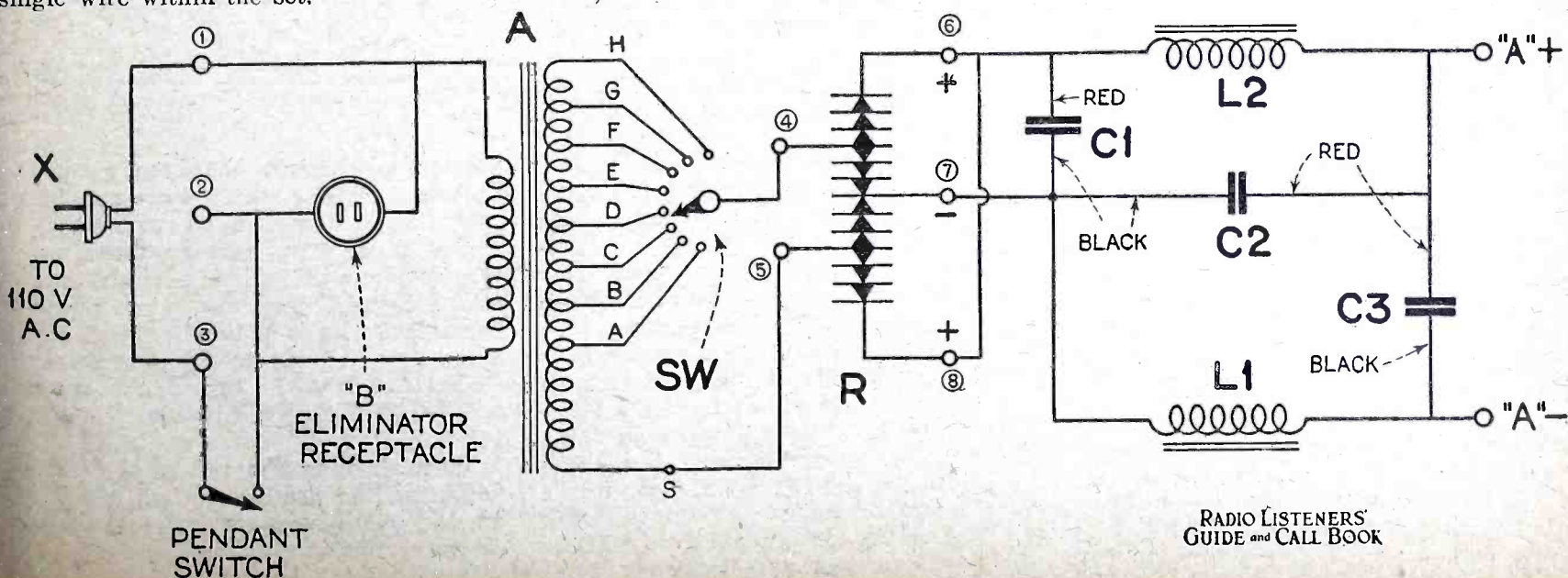
A side view with covers removed of the "A" power device as described in this article. The placement of the transformer, chokes and condensers can be clearly seen.

ternating current into a steady direct current for the operation of any tube. Certain large receiver manufacturers have already adopted the same method in preference to the use of A.C. tubes.

The assembly of the unit shown in the photo heading of this article and diagrams, completely eliminates all "A" storage or dry batteries of all types as well as chargers and trickle chargers. There isn't a moving part in it—and nothing to replace except a metallic rectifier every year or so. Unlike A.C. tube operation, this device completely replaces the old battery system without changing even a single wire within the set.

Mount both choke coils on the base as shown in the diagram layout. Next take the transformer (symbol A) and before mounting, scrape the enamel off the wire taps and primary lead wires. Place the transformer on the right hand side of the base plate, opposite choke L-2, so that the taps are on the outside edge, with the primary leads coming out of the top. Four machine screws hold the transformer tightly to the base plate.

The long condenser supporting brackets (see photo) are next placed into position. The front bracket is fastened to the vertical lugs located 1 5/8 inches from the front, while the back bracket is mounted



RADIO LISTENERS' GUIDE and CALL BOOK

Schematic diagram of the Knapp "A" power unit parts are indicated to correspond with list of parts and picture diagram.

each stud, then run up tight by means of brass nut. An additional washer and nut is placed loosely on each stud until ready for wiring.

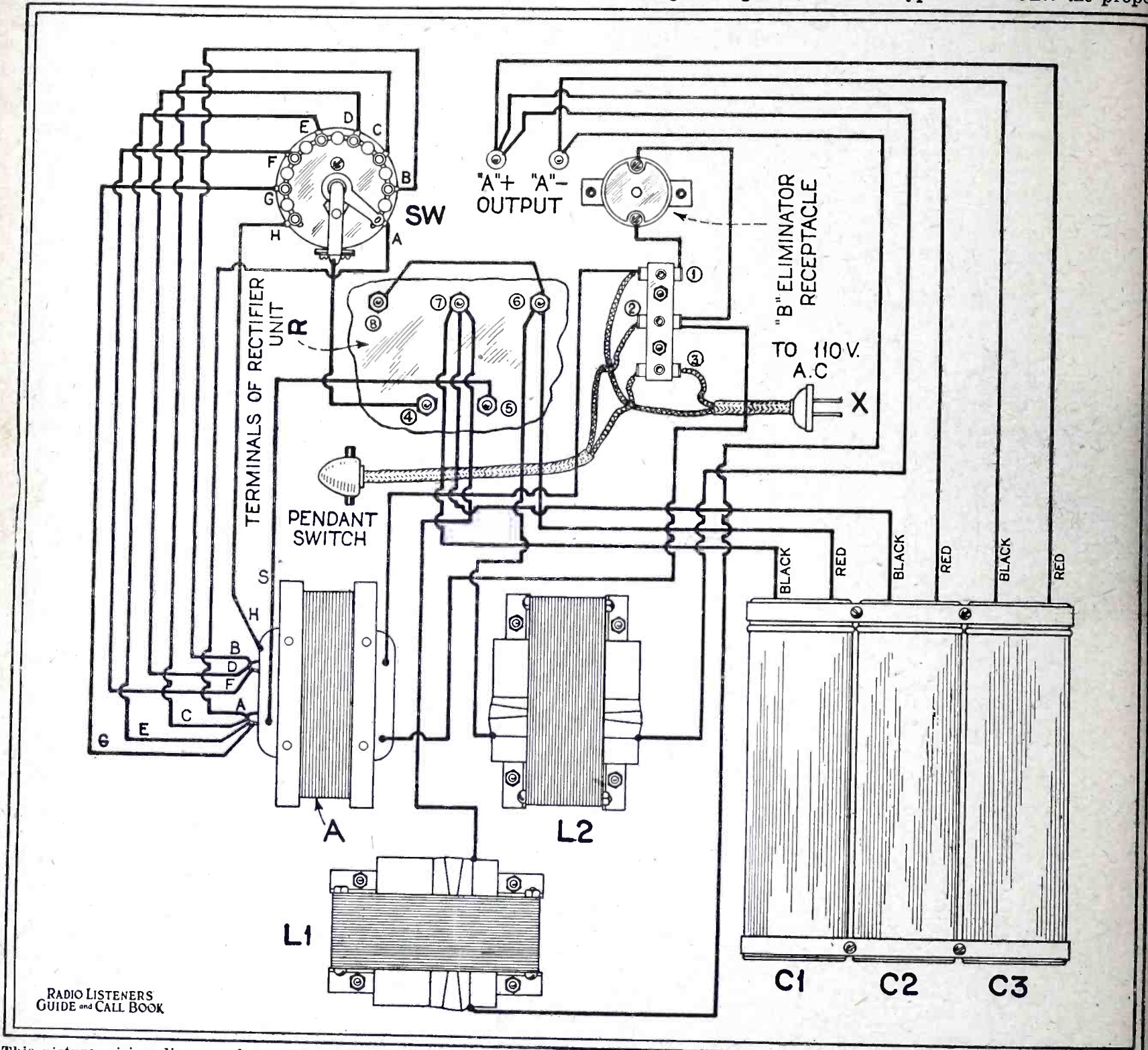
**Wiring Knapp "A" Power Kit:**—This completes practically all of the assembly work, and we are now ready to begin wiring. An eight foot length of rubber covered hook-up wire is required. It will be best to prepare all the wire at one time,

for a preliminary test. Using the attachment cord plug, connect to an alternating current houselight lamp socket and press the red button of the pendant switch.

Now connect the "A" plus and "A" minus leads from the radio set to the binding posts similarly marked on the panel front of the Knapp "A" Power Device. The switch arm of the special eight

square opening facing downwards. The final step is to clamp on the metal top box cover.

The Knapp "A" Power Unit works equally well with "B" batteries or "B" eliminators. It is suitable for use with any radio set having up to eight tubes. A 6-volt supply is correct for all receivers employing 201-A, 112, 112-A, 171 and 171-A type tubes. Once the proper



This picture wiring diagram shows how all connections are made. Leads from condensers, C1, C2 and C3 are indicated with colors and terminal markings are given in either letters or numerals.

that is, to cut to length, skin ends and attach terminals.

The actual wiring is quite simple, as seen in the picture diagrams, which show each lead wire and terminal going between the several parts or electrical sub-assemblies. The schematic wiring diagram reveals the circuit in simplified form, showing the parts marked to correspond to the list of parts.

After the wiring has been carefully checked, fasten the front panel to the base-plate assembly by means of the two machine screws. The rectifier unit, R, should now be placed on the five contact posts, and the holding nuts then firmly tightened. The outfit is now ready

point switch should be set to indication, A. And if a "B" eliminator is employed the latter's plug attachment cord should be inserted in the "B" eliminator receptacle on the front panel.

If no broadcast signals are heard, advance the switch knob one point at a time until the tubes attain their proper brilliancy. Preferably, if a voltmeter is handy, adjust the switch until the binding post voltage reads 6 when all tubes are burning. Should everything check O. K., fasten the box metal body to the base assembly and front panel, using machine screws. The perforated rectifier cover may then be fastened to front panel. The cover should have the large

voltage adjustment has been made no further voltmeter readings are necessary, nor is any other attention required.

For small sets, such as those using three or four tubes, it is advisable to install a 6- or 10-ohm rheostat in the "A" minus lead wire so as to reduce the output voltage to 6. Under no circumstances should the tubes be operated above the rated voltage specified by their manufacturers.

When turning the radio set "on" or "off", use the pendant switch provided, leaving the filament switch of the receiver always in the "on" position. By following this practice the set may be controlled entirely by the pendant switch.

# The LISTENERS' ACCESSORY GUIDE

## Two-Way Line Voltage Regulator

THE small box-shape device illustrated in the photo herewith is a voltage regulator for use in connection with radio receivers. It has been designed to correct the house-supply voltage to 110, the potential usually required by electric sets. It will operate in any A.C. circuit, provided the voltage is not greater than 130 or less than 90, and it has an output of 100 watts, which is ample for the operation of the average set.



Photo by courtesy R. B. M. Mfg. Co.

The two-way line voltage regulator, described herewith. To obtain 110 volt current from a variable lighting supply this unit is simply connected in the supply leads to the radio receiver.

It is not difficult to appreciate the importance of an A.C. line-voltage regulator, since the chief cause of dissatisfaction with electric receivers has been the short life of the tubes. It was first thought by the experimenters that this condition resulted from poorly-designed tubes, but investigation has shown that variations in the 110-volt house-supply current are usually responsible for overloading the filaments and reducing tube life. A majority of the power transformers available for heating tube filaments are designed for 100-volt operation and an increase in the output voltage will cause a proportional increase in the output. Therefore, in areas where the house potential rises to 120 and 130 volts during the evening, the tube filaments operated with A.C. are dangerously overheated. On the other hand, insufficient power is frequently the cause of poor reception.

The voltage-regulating device illustrated provides the broadcast listener with a very simple method of regulating the input voltage to a receiver. It is a simple auto-transformer, equipped with a special A.C. buzzer which vibrates when the potential applied to the receiver reaches 110 volts. The interesting feature of the regulator is that a voltage-indicating buzzer operates automatically during adjustment, but is turned off by the removal of

the operator's hand from the adjustment knob.

Among other advantages this regulator will maintain the output potential at 110 volts for the operation of the radio receiver, regardless of whether the line-voltage is above or below this value; whereas resistors are capable only of reducing the voltage. Second, the unit has a range sufficient to cover all conditions. It will increase the voltage to normal value from as low as 90 volts, or it will decrease the voltage to normal from as high as 130 volts. Third, there are eight voltage taps, thus providing a very close adjustment. And fourth, it is highly efficient, as it regulates the voltage by reactance, rather than resistance.

The unit is housed in a metal box  $4\frac{1}{4} \times 4\frac{1}{4} \times 3\frac{1}{4}$  inches and weighs 3 pounds. It is provided with a cord and plug for connection to the lamp socket, and also with a 110-volt receptacle for the plug of the power transformers. The only adjustment is a knob which operates an eight-point switch.

## New "Link" Has Many Purposes

A MIDWEST manufacturer has marketed recently an all-purpose light-socket appliance which seems to have a knack of "doing things" in liberal quantities and with some gusto. This accessory



Photo by courtesy X-L Radio Laboratories.

The "link" unit as shown above furnishes aerial and ground connections as well as power supply for the A.C. set.

is obtainable in the form of a compact aluminum case measuring  $4\frac{3}{4} \times 3\frac{1}{2} \times 2$  inches and has mounted upon its top, two spring-clip binding posts, two receptacle outlets and a knob which controls a rheostat within the case. A six-foot silk cord provided with a band switch furnishes the means of connecting this unit to the

light-socket. A photo of the device is shown herewith.

The duties of the various components which are part of this unit as outlined above, are as follows: the two spring-clip binding posts are connected to the light lines through small fixed condensers, thus furnishing aerial and ground connections for the receiver. The two outlets are provided for "A" and "B" power units if used and are so wired that only one may be used if this unit is employed with an A.C. electric receiver. A power rheostat placed in series with the input line, serves as a voltage control and protects the power apparatus and tubes in the set from overload, caused by variations in line voltage. The unit is equipped with a fuse as specified by the Fire Underwriters, which automatically opens the 110-volt line should any part in the receiver or unit break down.

## A New High-Voltage Rectifier for "B" Eliminators

A DRY, high-voltage metallic rectifier of the "electronic" type has been designed to take the place of the gaseous bulb rectifiers now being used in various "B" power units employing full-wave rectifying circuits. The photos herewith depict the new rectifier in both partially-complete and assembled forms. Outwardly it has all the appearance of a screen-grid tube shield. It is  $5\frac{1}{8}$  inches in height,  $1\frac{3}{4}$  inches in diameter and weighs ap-



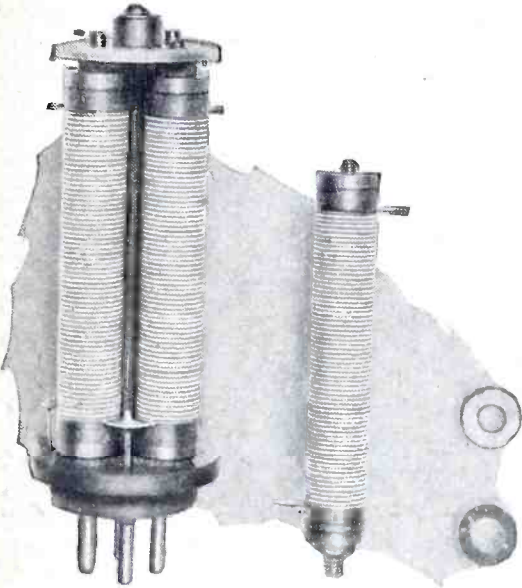
Photo by courtesy Elkon, Inc.

The dry rectifier unit for "B" eliminators.

proximately  $12\frac{1}{2}$  ounces. The fact that it is built upon a standard tube base permits its substitution for any gaseous-type rectifier tube designed for the UX socket.

This new item is a result of the development work of Dr. H. Shoemaker. Though the underlying principles of contact-rectification are not new, the perfection of their application to produce a dependable rectifier in low-voltage power systems is comparatively recent; even more so, its use where potentials in the order of 350 volts or more are dealt with.

One of the photos shows that its internal construction differs radically from all other forms of rectifiers used prior to



Component parts of the new high-voltage rectifier contained in the metal housing. Its base fits the standard UX type tube socket. Each stack is composed of alternate discs of cupric sulphate and magnesium alloy. The discs are seen at the right of the above photo.

the development of the metallic-disk type. Since the unit is very nearly all metal, and contains no glass envelope or supporting structure, it is obvious that little or no damage can come to it. The outer extruded aluminum casing serves essentially as a radiator of heat and completes the assembly.

The actual rectifier consists of a large number of "couples," each made of a disc of cupric sulphide in contact with an aluminum-magnesium combination. These coupling elements have the appearance of a large number of washers, and are 9-16 inch in diameter. In proper combination they are assembled into "stacks" and then, by means of clamping collars, are forced together hydraulically under a predetermined pressure. The sub-assemblies or stacks, four in number, are then interconnected electrically to fit the circuit for which the rectifier is intended; thus the base-plug provides for supplying the raw high-voltage alternating current to the coupling units and, finally, for taking off the rectified D.C. output component.

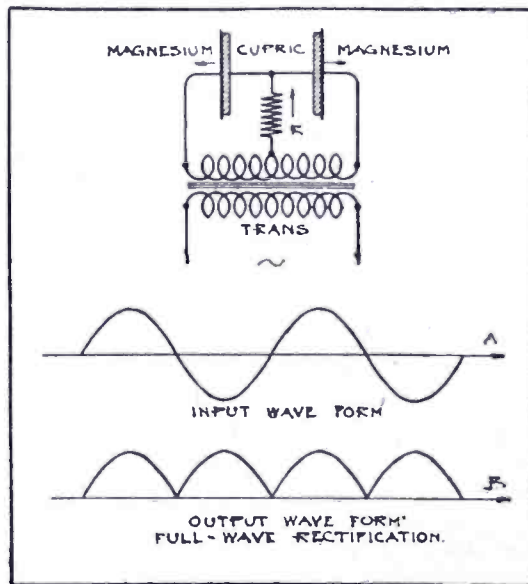
The operation of this type of rectifier is based upon the physical fact that, when bodies highly "electro-positive" and "electro-negative" (relatively) are brought into proper contact and current is passed, so that an electro-chemical reaction takes place at their junction, there is formed at the junction a film which permits the current to pass in one direction only.

Thus, when a disc of cupric sulphide is held, under sufficient pressure, in contact with a disc of magnesium, and an A.C. voltage of proper magnitude is applied across the junction, the film which has rectifying characteristics is formed generally during the first cycle; after which rectified current will pass from the cupric

disc to the magnesium disc. When the couples, comprising discs of cupric sulphide and magnesium, are held together by a pressure which insures substantially uniform contact throughout the junction, the current-blocking film formed is observed to unite the electrode discs as though they were fused together. There is thus formed a continuous conductor which has relatively high resistance to the passage of current from the magnesium to the cupric-sulphide disc, but a relatively low resistance to the passage of current from the cupric sulphide to the magnesium disc.

The diagram shows an elementary circuit producing full-wave rectification. It will be seen from the figure that two sets of couples are used, in series with each other and with a center-tapped transformer secondary, which delivers the required voltage. It will also be seen that the resistance R (or combination of plate-circuit currents demanded by the radio receiving set in practice) is connected from the center tap of the transformer secondary to a point in the circuit between the two sets of rectifiers. This circuit is, in fact, a combination of two half-wave rectifiers and each section of the transformer secondary must give sufficient voltage to force the required current through the load resistance R.

When the current flows in one direction, one set of couples will oppose its flow and the other set of junctions will allow the current to flow through it. When the direction of the current is reversed,



In each half-cycle, the current flows through a different set of discs, but in the same direction through R; thus putting both halves of the "wave-form" A above the line, as at B.

the rectifier junctions that previously allowed the passage of current become "blockers" of this current. When the current is a second time reversed, they again pass it. In this manner the two sets of junctions alternate with the flow of the current in functioning as blockers and conductors. This keeps the direction of the current through the resistance R the same during each half-cycle. The line "A" in the diagram shows the theoretical alternations of the current as it leaves the transformer secondary, and "B" the wave-form of the current after both halves of the wave are rectified.

## A Power-Amplifier for Dynamic Speakers

THE present wide popularity of the dynamic speakers which require field-coil excitation with 110-volt direct current, and the recent innovation of adding power amplifiers to phonographs, have led to the design of a neat, compact amplifier.

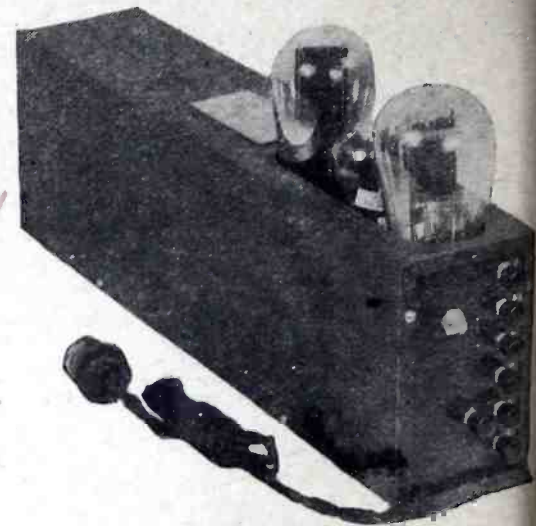


Photo by courtesy Silver-Marshall, Inc.

This power amplifier can be used in connection with a dynamic speaker for quality and music volume reproduction and pick-up.

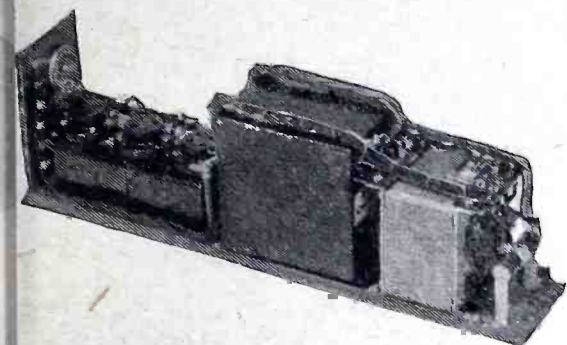
This amplifier is particularly adapted for use with a phonograph and an ordinary magnetic pick-up. Used in this manner, it has been found to give excellent reproduction of electrically-cut records, with sufficient volume to fill a small theater at orchestra intensity.

Supplied with current from the house wiring at any voltage between 105 and 120 alternating at 50 to 60 cycles, the amplifier compact delivers the necessary rectified current to the dynamic speaker's field coil, and supplies all necessary "A," "B" and "C" power to its own two amplifying tubes. With its input side connected either to the detector tube of a radio set or to a magnetic phonograph pick-up, and its output side across a good dynamic speaker, the result is undistorted reproduction with a volume running, under control, to the full capacity (approximately 5,000 milliwatts) of the 250-type tube.

The audio-frequency transformers used in this amplifier are of the "Clough" type, rated by the manufacturers as having practically a straight-line characteristic from about 50 cycles to the upper limit of the audible frequency range. The design of each transformer comprises an auto-transformer, a resistor and a blocking condenser, all mounted in one case and connected in circuit. External connections are made just as to any transformer of the conventional primary-secondary type. The direct plate circuit of the preceding tube passes through the resistor alone, while the A.C. signal impulses flow through only the condenser and the lower or primary portion of the amplifying auto-transformer.

Standard components are used in the construction of the amplifier, which is

built into a crackle-finish steel case 3 3/8-inches wide, 5 1/4 inches high, and 17 inches long. All connections are made to a small panel at one end of the case, and the three tubes project through the top of the case to facilitate their heat radiation. The latter are a 281-type rectifier



The power amplifier unit with casing removed to show parts.

tube, a 226-type amplifier tube in the first stage, and a 250-type amplifier tube in the last stage. The amplifier will operate one speaker with a 90-to-120-volt field, while a second (of the 110-volt A.C. type) can be added if desired.

### A New Heater Type Power Tube

INCREASED life of the 71 type medium power tube has been found in the design of a heater type tube having the same amplifying characteristics as the filament tube. Under average conditions the life of a well designed heater tube is well above 2000 hours according to the report of a prominent tube manufacturer.



Photo by courtesy Arcturus Radio Co. This tube is of a 71 type power amplifier with a heater element.

It is claimed that the emission characteristics of the heater tube remains constant throughout the life of the filament or heater element due to the relatively large cathode area, there being no decline in efficiency necessitating reactivation, as is characteristic of many filament type tubes.

The tube shown in the accompanying photo has an amplification constant of 3, a mutual conductance of 1500, plate resistance of 2000 ohms and operates from a five volt direct current or A.C. source. This tube is merely substituted for the 71

type tube in the radio receiver without making any changes in the wiring or voltages.

In addition to the life factor, the humless operation of the heater tube is an added feature for use in A.C. receivers and other sets in which the power tube is heated from a transformer.

### A Short-Wave Converter Unit for the Radio Receiver

WITH the present interest in short-waves and the commercial demand for a short-wave unit adapter that can be connected to the amplifier of the average

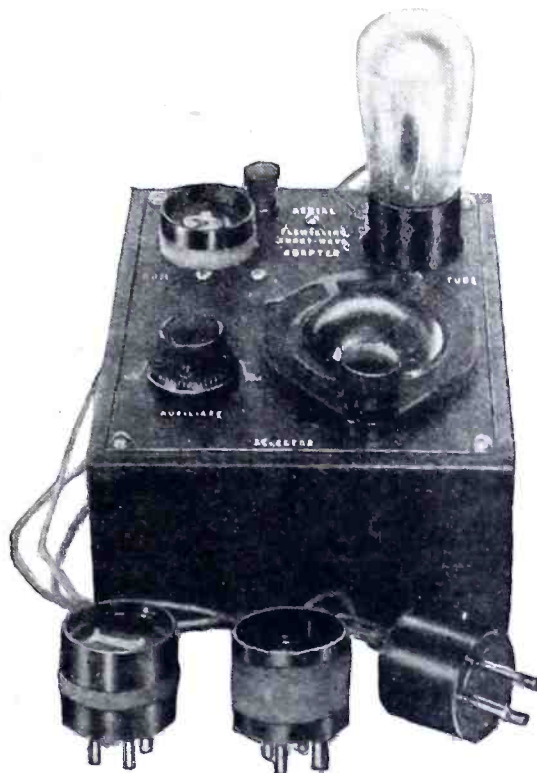


Photo by courtesy A-C Dayton Co. This short wave converter can be connected to any standard receiver. It employs a conventional regenerative circuit.

broadcast receiver, with little or no change in wiring, there have appeared on the market a number of such items well suited for the purpose in view.

Among these is the adapter illustrated herewith. It employs the conventional regenerative circuit with a semi-aperiodic primary, and a fixed tickler which is capacitively tuned with a midget condenser. This method of controlling regeneration is practically trouble-proof and the one generally employed by the majority of short-wave experimenters.

It can be used with any broadcast receiver using a UX socket in the first radio-frequency or detector stage. Three plug-in coils are supplied with each adapter. Coil No. 1 has a wavelength range between 17 to 29 meters. Coil No. 2 covers from 27 to 48 meters, and coil No. 3 is from 47 to 84 meters. Thus, it can be seen, with the set the adapter has a complete coverage of the channels ranging from 17 to 84 meters.

Should the wavelength range of the receiver be found insufficient, additional coils may be wound on a standard UX tube base.

Attachment to the average run of tuned-radio-frequency receivers, whether battery or A.C. operated, is a simple matter. First adjust the receiver to a high wavelength, with all dials tuned and all controls set just as though a distant station was being tuned in. Use any wavelength between 450 and 500 meters when no local station is received. Remove the first R.F. tube and insert the cable plug adapter in its socket, and then place the tube in the adapter socket. The aerial lead must be removed from the receiver and connected to the "antenna" binding-post on the adapter, which is then ready for tuning. The adapter then operates as a frequency-changer, and the R.F. unit as an intermediate amplifier.

All parts of this unit are mounted on a black bakelite panel, which is set into the top of a cabinet measuring only 7x5 1/2 inches on the base and 2 3/4 inches high. Vernier control is provided for the tuning condenser, while the regeneration condenser is controlled by a knob, no fine control of oscillation being necessary.

### High-Voltage "B" Battery Suitable for Television

A NEW plate battery, emulating the "skyscraper" trend of design, is now being marketed by a mid-west manufacturer. A significant note in the production of these batteries can be found in the fact that they are specified for use with the photoelectric cell and the neon tube. Also, they may be found to be a space- and weight-saving factor in radio-equipped airplanes, for which they were originally designed.

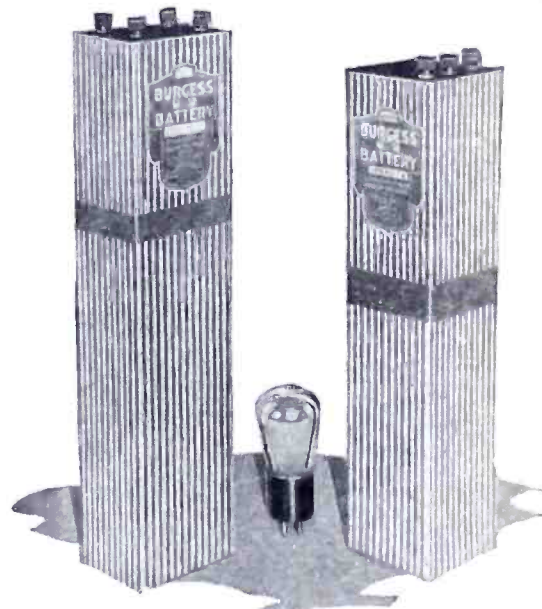


Photo by courtesy Burgess Battery Co. These batteries are designed to take up a minimum of space, as will be seen by comparison of their size with the standard tube between.

They are marketed in two types. One is a battery having a voltage of 108, which measures 15x3 3/8x2 5/8 inches, and weighs 6 1/3 pounds. It is equipped with four binding posts and provides the following values: 36, 72 and 108 volts.

The other is similar in design, but has a maximum of 144 volts, with a 54-volt tap. It measures 13 3/4x3x3 inches and weighs 5 2/3 pounds.

# The RADIO SET MARKET

This department is conducted in the interest of our readers who either build sets for sale or desire to have sets built to order. Anyone desiring to communicate with setbuilders whose notices appear in these advertisements can do so by addressing correspondence to the key number of each setbuilder in care of RADIO LISTENERS' GUIDE AND CALL BOOK, 230 Fifth Avenue, New York City.

All advertisements of custom set-builders appearing in the radio set market are published without cost or obligation. How-

ever, the publishers reserve the right to reject any advertisement which in their opinion appears illegitimate or cases where concerns merchandising parts would take advantage of this offer to custom set-builders. No more than fifty words to each advertisement and only one advertisement is allowed to each party or concern. Each request must be written on a separate sheet of paper to which must be attached the special coupon given in the notice appearing on another page preceding the feature articles in this issue.

## MIDDLE ATLANTIC STATES New York, New Jersey, Pennsylvania

- No. 530—Custom setbuilder in Albany, N. Y., will build any circuit from a one-tube set to a broadcast station. Tyrman Imperial 80 on demonstration. Radio specialist since 1917. Service plus guaranteed workmanship. Business strictly cash.
- No. 520—Custom setbuilder in Bayville, N. Y., will build any type of custom-made set to order. Short wave receivers and Silver-Marshall parts and sets a specialty. Old sets electrified. Authorized Silver-Marshall Service Station.
- No. 440—Custom setbuilder in Binghamton, N. Y., will build all the latest kits to order. Specializes in Silver-Marshall, Hammarlund-Roberts and Thordarson 250 radio and phonograph amplifiers with Magnavox dynamic speakers. Models on display. All sets electrified.
- No. 119—Buy a custom built radio set from a setbuilder in Brewerton, N. Y. All circuits built of national advertised parts. All work guaranteed whether rebuilt or new.
- No. 148—Custom setbuilder in Brooklyn, N. Y., will build latest circuits to order. Specializes in A.C. shield grid sets. Sets from 1 to 14 tubes built.
- No. 175—Professional custom setbuilder in Brooklyn, N. Y., has facilities for construction of all high grade sets, irrespective of type. Specified equipment only considered in assembly. Specializes in Hammarlund-Roberts, Browning-Drake, Super-Hilodyne and Super-Heterodyne receivers.
- No. 268—Setbuilder in Brooklyn, N. Y., has for sale the following. One Freshman Masterpiece, one three tube portable also an R.E.L. short wave receiver and some Ham parts and will build any short wave set or any type of set to order. All work guaranteed.
- No. 253—Setbuilder in Brooklyn, N. Y., will build any make of set to order with standard parts and circuits used. Will rematch condensers which improve reception and selectivity on one-dial sets. Seven years experience.
- No. 277—Setbuilder in Brooklyn, N. Y., will build to order any type of radio set for A.C. or battery operation.
- No. 427—Radio-trician in Brooklyn, N. Y., specializes in all standard kit sets, circuits appearing in Radio Listeners' Guide and Call Book and Radio News, such as the Strobodine D.C., Scott Shield Grid Nine, Hammarlund-Roberts and Silver-Marshall sets.
- No. 436—Setbuilder in Brooklyn, N. Y., student of National Radio Institute, will build all sets to order. All sets repaired. All work guaranteed.
- No. 444—Setbuilder in Brooklyn, N. Y., will build any sort of set to order. Specializes in D.C. All-Electric sets.
- No. 508—Custom setbuilder in Brooklyn, N. Y., will build any radio set or power pack featured in this magazine. Repairing of all kinds. Authorized Silver-Marshall Service Station.
- No. 125—Setbuilder in Buffalo, N. Y., can build any set you wish at right prices. Fully equipped with accurate test instruments. Also maker of famous power antenna for more stations and distance.
- No. 179—Custom setbuilder and radio consultant in Buffalo, N. Y., will build or design any circuit to order. Modernizing sets a specialty. 12 years' practical experience. Associate of Institute of Radio Engineers. Will build anything from a 1-tube receiver to broadcast station. All work guaranteed.
- No. 151—Setbuilder in Buffalo, N. Y., can build any make of set to order. Victoreen Super-Heterodyne specialist.

No. 110—Custom set builder in Cohoes, N. Y., will construct any nationally known circuit at very reasonable prices. Authorized Silver-Marshall Service Station.

No. 118—Setbuilder in Elmira, N. Y., has one 8-tube Super-Heterodyne for sale—walnut case, Goldsmith circuit, A-1 condition. Will rewire, repair or build any type set or amplifier. Also repair "A" and "B" eliminators of any make. All work guaranteed.

No. 445—Custom setbuilder in Far Rockaway, N. Y., will repair or build any type of radio set, power pack and push-pull amplifiers. All work guaranteed. Specializes in Silver-Marshall sets. Authorized Silver-Marshall Service Station. Service to all parts of Nassau and Suffolk County, N. Y.

No. 250—Custom setbuilder in Frankfort, N. Y., will build or repair any standard circuit of the day, also A & B eliminators and television apparatus. Factory specifications followed whenever available. Silver-Marshall products a specialty. Authorized Silver-Marshall Service Station.

No. 523—Authorized Silver-Marshall Service Station in Gardenville, N. Y., has facilities for building or repairing Silver-Marshall sets, power units, amplifiers or other apparatus.

No. 180—Radio consultant and professional custom setbuilder in Hastings-on-Hudson, N. Y., will build any set to order. All types of sets remodeled and repaired. Complete laboratory testing equipment used and all work guaranteed. All kits and accessories in stock. Authorized Hammarlund-Roberts and Silver-Marshall Service Station.

No. 460—Custom setbuilder in Ithaca, N. Y., specializes in Silver-Marshall Screen Grid sets and power amplifiers. Service and repairs on all sets and amplifiers. Authorized Silver-Marshall Service Station. A deposit of 25% must accompany all C. O. D. orders. Satisfaction guaranteed.

No. 240—Radio expert and professional setbuilder in Jamestown, N. Y., will convert all sets for A.C. operation. Kits wired and sets tested. Antennas erected and sets installed.

No. 262—Authorized Silver-Marshall setbuilder in Corona, L. I., N. Y., builds and repairs radio receivers at a reasonable price. All popular A.C. or battery operated receivers made to order such as Tyrman A.C. 72, Imperial 80, Victoreen and all Silver-Marshall receivers.

No. 476—Custom setbuilder in Long Island City, N. Y., having complete laboratory equipment to render quick and efficient service, will build to your requirements sets, power packs, amplifiers, short wave sets and converters. Authorized Silver-Marshall Service Station.

No. 138—Custom setbuilder in Richmond Hill, L. I., N. Y., will build sets, "B" eliminators and power packs to fit your requirements. Will also electrify your old sets.

No. 424—Setbuilder in Syosset, L. I., N. Y., builds any type of modern radio receiver and short wave sets to order at reasonable prices. Expert work with guaranteed satisfaction. Also quick antenna service and repairs anywhere within twenty miles.

No. 132—Four or five-tube sets with cabinet made by setbuilder in New Rochelle, N. Y. Wonderful DX "go-getters."

No. 104—Setbuilder in New York, N. Y., builds "Everyman 4" complete, including tubes, "A" battery, "B" eliminator (180 volts), and cone speaker.

No. 109—Setbuilder in New York, N. Y., specializes in Hi-Q receivers. Can also build any set to individual specifications. Associate of Institute of Radio Engineers.

No. 124—Radio Rex of New York, N. Y., will build any set to order. Specializes in Magnaformer 9-8. All inquiries answered promptly.

No. 133—Latest sets built and installed by a custom setbuilder in New York, N. Y. Sets repaired and rewired. Expert on S-M Shielded Grid Six, Tyrman Seven, Hammarlund-Roberts Hi-Q Six and all makes of power packs.

No. 134—Sets built to order by custom setbuilder in New York, N. Y. Old sets remodeled and brought up-to-date. Electrifying sets our specialty. Authorized service station for Atwater-Kent, Fada, Freshman, Sonora, Stewart-Warner and Grebe receivers.

No. 154—Setbuilder in New York, N. Y., specializes in custom-built A.C. and D.C. receivers and power packs. No order too large or too small. At your service.

No. 194—Certified radio-trician in New York, N. Y., with five years' experience, specializes in Shielded Grid circuits and Super-Heterodynes. Orders received for any circuit, eliminators and power packs. Complete kits and accessories for sale. Technical questions answered free of charge.

No. 219—Setbuilder in New York, N. Y., specializes in Acme, Victoreen and Silver-Marshall. Sets made to order. Repairing a specialty. Can also build a short-wave tuner—just plug it into your present set—the results are wonderful.

No. 221—Setbuilder in New York, N. Y., has custom built 3-tube radio set for sale. Only one dial and very compact. Uses small loop aerial which is contained in the set. Has excellent volume and tone quality with a hundred mile range.

No. 237—Custom setbuilder in New York, N. Y., catering to musical instructors has a seven-tube receiver of his own design for sale. This radio set has a guaranteed range of 2,000 miles; remarkable tone fidelity and tremendous volume. Will duplicate to order and to external specifications only. Four weeks delivery on orders.

No. 272—Have a set built into your old favorite cabinet by a super-heterodyne expert in New York, N. Y., or change your old receiver to use the new A.C. screened grid tubes with guaranteed results. Sets converted to A.C. operation. Will build any make of receiver or power pack, and will service same free for one year.

No. 312—Custom setbuilder in New York, N. Y., specializes in Silver-Marshall sets. Any set built to order. Finest materials and workmanship. Authorized Silver-Marshall Service Station. Power packs and eliminators non-motorboating to order.

No. 321—Radio expert in New York, N. Y., will build, rewire or repair any type of set, speaker, eliminator or power amplifier. Remote control and radio-teleautomatic devices a specialty. Inventor of the Copeman radioplane. No order too large or small. Certified consultant.

No. 326—Custom setbuilder in New York, N. Y., specializes in Hammarlund-Roberts Hi-Q, Browning-Drake, Screen-Grid, and Quadraformer. Will make any set A.C. operated. All types of power packs including 250 with dynamic output. Will repair any make radio set. All work guaranteed. Quick service. Deposit on all orders.

No. 332—Setbuilder in New York, N. Y., will build sets of supreme tone quality in cabinets of distinction. All-electric sets for direct current a specialty.

No. 372—Professional set designer and builder in New York, N. Y., has facilities for construction of all standard kits and sets for prompt delivery. Member Associate Institute Radio Engineers. No construction considered unless specified apparatus is used. Specializes in Erla reflex and Ultradyne Super-Heterodynes of all types.

No. 432—Custom setbuilder in New York, N. Y., has 7-tube A.C. electric long distance set, own design, complete with dynamic speaker, console table model cabinet, walnut finish, for sale. Economical to operate. Delivery 10 days after order is placed.

No. 458—Custom setbuilder in New York, N. Y., specializes in Silver-Marshall sets, B eliminators and power packs. Can also build and electrify any set to individual specifications. Repairing done on all makes of sets. Authorized Silver-Marshall Service Station.



No. 487—Radio sets of all makes built and repaired by setbuilder in New York, N. Y. Authorized Silver-Marshall and Hammarlund-Roberts Service Station.

No. 488—Authorized Silver-Marshall expert in New York, N. Y., will build any of the S-M sets of charge. Special price on the Round-the-world Four or Coast-to-Coast Four. All kits and sets in stock at lowest prices. For sale at very prices, used sets, speakers and eliminators.

No. 516—Sets built to order by custom setbuilder in New York, N. Y. Authorized Silver-Marshall Service Station. Specializes in A.C. and D.C. receivers and power packs, also battery sets and Air-Chrome Speakers in stock.

No. 528—Professional setbuilder in New York, N. Y., is prepared to build, install, service and repair all types of Silver-Marshall receivers and power supply units. Authorized Silver-Marshall Service Station.

No. 562—Setbuilder in New York, N. Y., builds all kinds of radio receivers. Specializes in four-tube Diamond of the Air with or without screened tube. Satisfaction guaranteed with every set. Member of R.A. of A., and A.R.R.L.

No. 304—Custom setbuilder in North Lawrence, N. Y., will build Super-Heterodynes to order. Expert repair work on all types of receivers. Brown-Drake sets a specialty, latest models for sale. Power amplifiers and reproducing equipment for home and auditorium use.

No. 113—Authorized Silver-Marshall service man Patchogue, N. Y., will build, remodel or repair any type of set. Sets carried in stock. Experience since 1910.

No. 164—Setbuilder in Pittsford, N. Y., will build any kind of set you wish.

No. 249—Custom setbuilder in Plattsburgh, N. Y., specializes in Remler Best 115 Kilocycle 9-tube Super-Heterodyne. Any make set built to your pet piece of furniture, or in standard form.

No. 314—Setbuilder in Rochester, N. Y., will build sets to order. Only the best and specified parts used. Workmanship guaranteed, prices moderate. Have quantity of odds and ends of radio sets for sale. Member of A. R. R. L.

No. 367—Setbuilder in Rochester, N. Y., will build your custom radios at from 10 to 15% discount from list prices. All work guaranteed. Three years' experience. Work endorsed by National Radio Institute at Washington, D. C.

No. 207—Setbuilder in Rockaway Beach, N. Y., will build to order all latest types of radio circuits to meet your own ideas as to style and performance. Special consideration given to all orders for Tyrman "70" using the new shielded-grid tubes. Above service to all points on Long Island.

No. 456—Sets built to order by custom setbuilder in Port Richmond, S. I., N. Y. Old sets remodeled up-to-date, also electrified. Authorized repair for Harkness battery and electric sets.

No. 115—Setbuilder in West New Brighton, S. I., N. Y., is specialist in custom built sets and Super-Heterodynes. Will repair or build any type of radio set or power pack. All work guaranteed.

No. 376—Setbuilder in Tuckahoe, N. Y., will build or repair any set. Complete laboratory equipment.

No. 479—Setbuilder in Watertown, N. Y., will build any set desired. Sets modernized and rebuilt. Satisfaction guaranteed. Best parts will be used.

No. 446—Custom setbuilder and radio-trician in West Albany, N. Y., will repair and build all types of A.C. and D.C. sets.

No. 350—Setbuilder in White Plains, N. Y., has designed sensational new 3-tube Ambassador circuit. Gives phenomenal distance, code and local reception. Will build same for you. Particulars upon request.

No. 551—Setbuilder in Atlantic City, N. J., will build, install and service all Silver-Marshall sets and power packs. Silver-Marshall Service Station.

No. 197—Setbuilder in Barrington, N. J., will build any type of set to order. Battery sets converted to operate direct from house current. Expert service anywhere in southern New Jersey and Philadelphia. Tubes tested and rejuvenated free of charge.

No. 187—Custom setbuilder in Bayonne, N. J., specializes in special power packs and power amplifiers. Also on Silver-Marshall super-heterodynes.

No. 265—Custom setbuilders in Belleville, N. J., has for sale four stages Hiler Impedance, Sixteen units. Output from 2-210's. Low notes shake the walls. Flat response from 20 to 16,000 cycles. Great for television. Uses two separate power supplies. Each instrument can be heard separately. Any set built to order.

No. 417—Graduate radio-trician in Belleville, N. J., constructs sets, power packs, amplifiers and loud speakers, also adjustments and repairs.

No. 399—Setbuilder in Bloomsbury, N. J., will build any type of set desired. Specializes in Silver-Marshall sets. Sets delivered and installed within one hundred miles.

No. 103—Expert radio-technician in Camden, N. J., specializes in Silver-Marshall Screen Grid Six receivers. Authorized Silver-Marshall and Hammarlund-Roberts Service Station. Television apparatus, power packs, and short wave receivers custom built to your order. Amplifier systems built for churches, schools, etc. Complete laboratory testing equipment used. All work guaranteed.

No. 163—Setbuilder in Cliffside Park, N. J., specializes in Hammarlund-Roberts and Silver-Marshall receivers. Also short wave receivers and transmitters. Sets for special purposes designed and built. "B" eliminators repaired. Old sets rebuilt and repaired.

No. 478—Authorized Silver-Marshall Service Station in Clifton, N. J., builds and repairs all Silver-Marshall sets and power units.

No. 203—Custom setbuilder in Dumont, N. J., has five and six tube radio frequency sets for sale. Specializes in this kind of set. Will build any kind of receiver to order. Prices reasonable.

No. 251—Setbuilder in Jersey City, N. J., has 4 and 5-tube Diamond of the Air and 2-3-4 tube reflex sets for sale. Can build or rebuild any make set to order.

No. 536—Expert setbuilder in Jersey City, N. J., has the Melo-Heald Eleven and Fourteen tube standard receivers for sale, A.C. or battery operation. Literature gladly sent upon request. Can build any set to order. Graduate electrical engineer.

No. 178—Setbuilder in Keyport, N. J., will build and repair all makes of radio sets. Specializes in Silver-Marshall Screen-Grid receivers.

No. 147—Setbuilder in Lakehurst, N. J., will build sets the way you want them. Push-pull amplifiers and shielded grid sets a specialty.

No. 276—Setbuilder in Linden, N. J., specializes in building the Magnaformer receiver and also other types of sets, "B" eliminators and power packs. Will repair any radio set. One year's service.

No. 116—Setbuilder in Newark, N. J., specializes in Hammarlund-Roberts Hi-Q 6 and Everyman 4 sets. Built to your specifications. Expert service on all sets. References and particulars on request.

No. 352—Custom setbuilder in Newark, N. J., has Hammarlund-Roberts Hi-Q 6 battery and electric sets for sale. Will build any set, eliminator or amplifier to order with specified parts at lowest prices.

No. 396—Setbuilder in Newark, N. J., has 3-tube Popular Mechanics Loop sets, one dial control, for sale. Also one Atwater Kent No. 20.

No. 532—Custom setbuilder in Newark, N. J., will build, service and repair any make of circuit. Your old set remodeled. Sets electrified. Consultation free.

No. 375—Setbuilder in North Bergen, N. J., will build any circuit to order. Specializes in LC. 28 sets and short wave converters.

No. 172—Setbuilder in Passaic, N. J., specializes in A.C. sets, "B" eliminators, and special step-up or step-down transformers. All work guaranteed.

No. 156—Setbuilder in Phillipsburg, N. J., builds sets, loud speakers and amplifiers for theaters, sound pictures and public address systems. Specializes in Silver-Marshall 710-720 and 740 Shielded Grid receivers, Scott Shielded Grid Nine and Tyrman Shielded Grid A.C. 6-7-8. World's Record Super 10 at exceptional low price. Workmanship guaranteed. 72 hour service.

No. 517—Custom setbuilder in Westfield, N. J., specializes in sets of quality, Scott, Lincoln or Silver-Marshall Supers in special cabinets with electric pick-up for records. Authorized Silver-Marshall Service Station and Associate Member of Institute of Radio Engineers. No job too small or too large. Will build any set on order.

No. 281—Setbuilder in Allentown, Pa., specializes in the building of reflex, Browning-Drake and Hammarlund-Roberts circuits. Best quality parts used at the lowest consistent price, guaranteeing the greatest satisfaction.

No. 344—Authorized Hammarlund-Roberts and Silver-Marshall Service Station conducted by graduate radio-trician in Altoona, Pa., specializes in modernizing your old receivers. Satisfaction guaranteed.

No. 297—Setbuilder in Bethlehem, Pa., builds the Magnaformer 9-8 Super-Heterodyne. Good selectivity and great volume.

No. 407—Setbuilder in Bethlehem, Pa., specializes in 5 and 6-tube sets, Aero short wave sets and converters, 3- and 4-tube Browning-Drake receivers. Three-tube sets for sale. Will also build A-B-C eliminators and amplifiers. Repairing done on all kinds of sets.

No. 472—Custom setbuilder in Bethlehem, Pa., will service any type of set. Repairing and installations neatly done. Authorized Silver-Marshall Service Station.

No. 313—Setbuilder in Chester, Pa., can build any make of set to order. Specializes in kit sets.

No. 328—Custom setbuilder in Chester, Pa., builds receivers free for price of parts. Specializes in H.F.L. Isotones, Tyrman, Hammarlund-Roberts, Scott, Silver-Marshall receivers in any type. All types and models of sets built to customers' wishes. Equipped to construct any type of radio apparatus. Electric phonographs constructed. Speedy, guaranteed repair service.

No. 480—Radio-trician in Chester, Pa., will build or repair any make of D.C. or A.C. receiver, public address system or power pack. Authorized Silver-Marshall and Hammarlund-Roberts Service Station. Satisfied customers, quick service and moderate rates are my watch words. Graduate of National Radio Institute.

No. 217—Setbuilder in Crafton, Pa., has custom built Browning-Drake 4-tube sets for sale. Will also build any make of set to order.

No. 324—Custom setbuilder in Easton, Pa., has one Silver-Marshall Shielded Six (type 630) and one Aero Short Wave Converter (verification from England and France) for sale at a reasonable price. Specializes in Silver-Marshall and Aero sets, but can build all types. Authorized Silver-Marshall service station.

No. 560—Custom setbuilder in Erie, Pa., will build any make of radio set, phonograph amplifier or public address system. Laboratory test made on all radio sets to analyze troubles. Scientific repairing. Workmanship guaranteed.

No. 543—Custom setbuilder in Franklin, Pa., will build or repair any radio set to order. Specializes in S-M kits and parts. Satisfaction guaranteed and prices right. Authorized Silver-Marshall Service Station.

No. 430—Setbuilder in Greenville, Pa., will build any set or circuit you wish. Specializes in modern amplifiers. Ten years' experience in radio and six years of it as professional service man.

No. 144—Setbuilder in Irwin, Pa., specializes in Browning-Drake and Silver-Marshall 4-tube Shielded Grid sets. All types of sets custom built.

No. 290—Custom setbuilder and service man in Kittanning, Pa., will build the set you would like to have with guaranteed tone quality, volume, selectivity and sensitivity. Individual requirements and preferences satisfied. Old sets remodeled, repaired, or taken in exchange. Authorized Silver-Marshall Service Station.

No. 434—Custom setbuilder in Lancaster, Pa., will build any set or circuit—broadcast, short wave, eliminator or amplifier—at list. Also repairing, rewiring or rebuilding. Guaranteed work. Prices quoted on request.

No. 330—Setbuilder in Mill Hall, Pa., will design and construct radio equipment to meet the requirements of your locality. Constructor of super-fine custom built radio broadcast receivers. Repair department is at your service.

No. 365—Custom setbuilder in New Kensington, Pa., with eight years' experience, will make old sets up-to-date, A.C. or D.C. Let me rewire that old set for better results. All work guaranteed. Authorized Silver-Marshall Service Station. Have 6-tube Aero-Dyne for sale.

No. 527—Professional custom setbuilder in Oil City, Pa., will build to order any set or apparatus described in Radio Listeners' Guide and Call Book. Will also build any Silver-Marshall or Hammarlund-Roberts receiver, amplifiers or power packs. All work guaranteed. Authorized Silver-Marshall and Hammarlund-Roberts Service Station.

No. 101—Setbuilder in Philadelphia, Pa., has on demonstration the latest Browning-Drake receiver. Will also build any set to order. Best material, workmanship and results at lowest prices.

No. 106—Modern up-to-date sets constructed and serviced by a setbuilder in Philadelphia, Pa. Tuned Radio Frequency, Browning-Drake and Neutrodyne a specialty. Power Amplifiers.

No. 123—Setbuilder in Philadelphia, Pa., specializes in Hammarlund-Roberts Hi-Q sets.

No. 141—Setbuilder in Philadelphia, Pa., has 6-tube Hammarlund-Roberts and Aerodyne sets for sale. Can build any make of set to order.

No. 149—Setbuilder in Philadelphia, Pa., builds high-grade receivers and power packs. Specializes in Super-Heterodyne, Tyrman 70, Hammarlund Hi-Q, Continental, H.F.L. Model 28, World's Record Super, and sets using screen grid tubes.

No. 155—Setbuilder in Philadelphia, Pa., has six and seven-tube sets for sale. Specializes in Aero Seven and Harkness Counterfonic. Can build any make set or "B" supply unit to order.

No. 191—Setbuilder in Philadelphia, Pa., specializes in A.C. sets. Will build to order any type of set.

No. 264—Custom setbuilder in Philadelphia, Pa., has 5-tube, one-dial DX Shielded T.R.F. sets for sale with walnut cabinet. Specializes in this type of set. Can build any make of set to order, also socket power amplifiers and eliminators.

No. 360—Setbuilder in Philadelphia, Pa., specializing in Silver-Marshall circuits and high class Super-Heterodyne receivers, now has on display a beautiful walnut floor console 5-tube all electric S-M DX circuit with built-in loud speaker. Any other circuit built to your order at moderate prices.

No. 394—Authorized radio-trician in Philadelphia, Pa., specializes in the Hammarlund-Roberts Hi-Q set. Any make set built to order. Also short wave sets built.

No. 461—All leading circuits built to your requirements by an expert with 20 years' experience in Philadelphia, Pa. Authorized Silver-Marshall Service Station. Complete laboratory testing equipment. Prompt repair service on all sets and power units.

No. 152—Authorized radio-trician in Pittsburgh, Pa., has Hammarlund-Roberts Hi-Q 6 and Tyrman "70" radios for sale. Demonstration at your request. Sets built to your order.

No. 358—Authorized Hammarlund-Roberts radio-trician in Pittsburgh, Pa., has the New Master and Junior models of the Hi-Q 29 for sale. Four years' experience on building and servicing Hammarlund-Roberts sets. All work guaranteed. Any set custom-built to order at small cost.

No. 370—Custom radio setbuilder in Pittsburgh, Pa., will build any set or apparatus described in *Radio Listeners' Guide and Call Book* on satisfaction or money back basis. Specializes in modernizing obsolete model receivers. All kinds of indicating instruments repaired and recalibrated.

No. 395—Setbuilder in Pittsburgh, Pa., will repair all makes of radio sets. Old sets rebuilt and improved and new sets built to order. Prices reasonable. Ten years' experience.

No. 515—Custom setbuilder in Pittsburgh, Pa., will build Silver-Marshall and Hammarlund-Roberts sets to order Silver-Marshall Service Station. No charge made for building, except for the list cost of parts. Endorsed by National Radio Institute, Washington, D. C.

No. 534—Authorized Silver-Marshall Radio Service Station in Punxsutawney, Pa., has facilities to take care of any of your radio troubles. Silver-Marshall apparatus a specialty. Old sets rebuilt to latest type, A.C. or D.C. All work guaranteed to give satisfaction.

No. 241—Setbuilder in Reading, Pa., has guaranteed custom-built radio receivers and short wave sets for sale.

No. 294—Setbuilder in Reading, Pa., has 9-tube Ultradyn and Silver-Marshall short wave sets for sale.

No. 205—Setbuilder in Scranton, Pa., has Tyrman "70" for sale. Write for our low prices on custom built sets. Repairing, designing and building any set on market.

No. 146—Setbuilder in Sharon Hill, Pa., is authorized Cardwell builder. My responsibility extends beyond ordinary guarantees and all designs are far in advance of commercial types.

### NEW ENGLAND STATES Connecticut, Maine, Massachusetts New Hampshire, Rhode Island

No. 129—National Radio Institute expert radio-trician in East Norwalk, Conn., is completely equipped for building, servicing and repairing any circuit, receiver or power pack. Authorized Silver-Marshall and Hammarlund-Roberts Service Station.

No. 493—Custom setbuilder in Guilford, Conn., will build or service A.C. or D.C. sets and Knapp A power units. Authorized Silver-Marshall Service Station.

No. 544—Custom setbuilder in Hartford, Conn., specializes in all types of Silver-Marshall receivers, power packs and eliminators. Will build any type of receiver desired. Official Silver-Marshall Service Station.

No. 331—Professional radio set constructor in New Britain, Conn., specializes in Geo. H. Cooper's 9-tube All Wave Super-Heterodyne set. 7x18" front panel and 7x17" sub-panel. Straight line sequence. Studied radio technology through I. C. S. schools.

No. 232—Setbuilder and experimenter in New Haven, Conn., has for sale the Lacault short wave set, International short wave receiver using one screen-grid tube, (this set is housed in Monel-metal cabinet), Ultradyn L2 and AmerTran A-B-C 2-stage power unit. Sets built to order. Prompt service.

No. 122—Setbuilder in New London, Conn., with years of experience in radio business, has custom made sets for sale. Can build any make of set to order. Prompt service.

No. 439—Experienced setbuilder in Putnam, Conn., will build the latest sets to order. Sets repaired, adjusted or electrified. Prompt service, good work. Authorized Hammarlund-Roberts and Silver-Marshall Service Station. National Radio Institute graduate.

No. 378—Setbuilder in Southington, Conn., will construct any set or power unit desired regardless of size. Old radios rewired, repaired and brought up-to-date.

No. 435—Custom radio setbuilder in Stafford Springs, Conn., will build any radio in kit form. Specializes in Tyrman Super-Heterodynes. Sets remodeled and repaired.

No. 242—Authorized Hammarlund-Roberts radio-trician in Staffordville, Conn., will build and repair all makes of sets and convert any type battery set to A.C. electric sets. Also have for sale 5-tube sets, 5-tube kits and power units. All work guaranteed.

No. 482—Radio-trician in Waterbury, Conn., will build, repair and service any kind of radio receivers. Power packs, eliminators, power amplifiers and television apparatus built to order. Authorized Silver-Marshall Service Station. Complete laboratory equipment. All work guaranteed.

No. 559—Setbuilder in Waterbury, Conn., will build or repair any make of set or power pack.

No. 127—Custom made sets built to order by a setbuilder in West Haven, Conn. No set too small, none too large. Also repairing and remodeling of all kinds. Have your old set made up-to-date. Tyrman "70", all electric, for sale.

No. 495—Custom setbuilder and radio-trician in Bangor, Maine, will build any make of radio receiver or power supply to order. Expert on super-heterodyne circuits. Endorsed by National Radio Institute. Authorized Silver-Marshall Service Station.

No. 377—Radio expert and custom setbuilder in Portland, Maine, will build any of the latest sets to order. Sets repaired and adjusted for the best results at reasonable prices. Old sets rewired for the new A.C. tubes. A trial is all I ask.

No. 452—Radio-trician in Portland, Me., offers expert service at a reasonable price. Specializes in Silver-Marshall receivers, power packs and eliminators. Will remodel your present receiver for A.C. operation.

No. 473—Authorized Silver-Marshall setbuilder in Auburndale, Mass., will build any set to order. Specializes in S-M 720 Screen Grid Receiver with the S-M A-B-C Unipac. Expert installation and repair service on any set.

No. 303—Setbuilder in Boston, Mass., builds excellent, low priced short wave receivers. This circuit was used by Commodore Dyott for his Roosevelt Memorial Expedition to the River of Doubt, Brazil, for constant communication with the outside world. Will repair any type of set.

No. 554—Professional setbuilder in Boston, Mass., will build A.C. and D.C. electric sets. Custom built television and short wave sets and converters. Reconditioned sets that have been taken in trade. Any make set repaired or installed. Ten years' experience. Authorized Silver-Marshall Service Station.

No. 320—Setbuilder in Cambridge, Mass., will build to order or service any radio set or power pack described in *Radio Listeners' Guide and Call Book*, for residents of Boston or vicinity. My laboratory is at your service.

No. 500—Master radio-trician in Chatham, Mass., specializes in Silver-Marshall and Hammarlund-Roberts sets. All types of sets built, remodeled and repaired. Complete kits and accessories for sale. Member Associate Institute of Radio Engineers. All work guaranteed. Six years' experience. Authorized dealer for Federal, Fada and Philco.

No. 441—Radio-trician in Harwich, Mass., with nine years' experience, will build or repair any type of long or short wave receivers, power amplifiers, dynamic speakers or what-have-you. Headquarters for R.C.A., Bosch, Eveready, Philco, Fada and Crosley sets.

No. 521—Authorized Silver-Marshall Service Station in Lowell, Mass., will build to your order any Silver-Marshall kit or power pack and will service any set. Will also build any advertised set.

No. 550—Setbuilder in Ludlow, Mass., will build custom built sets from three to fourteen tubes or power supplies to order. Any set repaired. No job too large, none too small. All work guaranteed. Former U. S. Navy operator and repair man.

No. 139—Setbuilder in Medford, Mass., has 5-tube Browning-Drake for sale. Sets built to order. Repairing and service work done at very reasonable prices.

No. 258—Setbuilder in Medford, Mass., will build any of the popular circuits to order. Power units and public address systems built and installed. Official parts used. Work guaranteed.

No. 114—Hammarlund-Roberts radiotrician in Natick, Mass., will inspect any set in trouble without cost. Will assemble any circuit. Hammarlund-Roberts a specialty. Tubes, batteries and all other accessories for any radio for sale on order.

No. 107—Professional setbuilder and radio expert in Quincy, Mass., will build any make of set to order. Workmanship and results guaranteed, using materials as specified in *Radio Listeners' Guide and Call Book*.

No. 468—Custom setbuilder in Roslindale, Mass., will build to order or service any radio set, power pack or address system. Sets converted for A.C. operation. Indicating instrument repaired and calibrated. Authorized Silver-Marshall Service Station.

No. 484—Custom setbuilder in Roslindale, Mass., specializes in Victoreen Super-Heterodyne and Silver-Marshall receivers, power amplifiers and eliminators. Repairing and rebuilding old sets to A.C. No. 740 A.C. 4-tube Silver-Marshall shielded grid for sale. All work guaranteed. Authorized Silver-Marshall Service Station.

No. 343—Professional setbuilder in Springfield, Mass., will build any set or circuit to order. Authorized Hammarlund-Roberts service station. Sets rewired for A.C. One year guarantee on any set. Graduate of N. R. I.

No. 195—Setbuilder in Worcester, Mass., has facilities to build on order any type set in sizes for homes or large halls. Factory built sets and accessories supplied where preferred. Builder and engineering graduate with seven years' experience. Personal service.

No. 243—Custom setbuilder in Chesham, N. H., has short wave adapters for sale cheap. Authorized Silver-Marshall Service Station. Silver-Marshall and Karas sets a specialty. Quality work at moderate prices. Sets repaired.

No. 243—Custom setbuilder in Chesham, N. H., has short wave adapters for sale; also Knickerbocker 4-tube sets. Will build any set or "B" power supply amplifier to order.

No. 263—Setbuilder in Pawtucket, R. I., has Everyman 4 sets for sale. Specializes in this kind of set. Can build any make of set to order.

No. 270—Radio technician in Woonsocket, R. I., will build sets to order. Super-Heterodyne expert.

### CENTRAL STATES

Alabama, Arkansas, Florida, Idaho, Illinois, Indiana, Iowa, Kansas, Kentucky, Louisiana, Michigan, Minnesota, Mississippi, Missouri, Montana, New Mexico, North Carolina, North Dakota, Ohio, Oklahoma, South Dakota, Tennessee, Texas, Vermont, Virginia, Washington, D. C., West Virginia, Wisconsin.

No. 388—Radio setbuilder in Powerly, Ala., will build to order any radio receiver. Specializes in 3-tube Ambassador sets.

No. 545—Custom setbuilder in Pratt City, Ala., will build to order any type of set. Also repair any set regardless of whether factory or custom built. Complete test equipment used. Authorized Silver-Marshall Service Station. Endorsed by the National Radio Institute, Washington, D. C.

No. 229—Setbuilder in Eureka Springs, Ark., can build any make of set to order. Send schematic or preferably picture diagram for estimate. Workmanship guaranteed.

No. 126—Setbuilder in Bradentown, Fla., can save you money on a custom built radio set and build it to suit you and your furniture. Will guarantee good reception and great distance.

No. 112—Setbuilder in Daytona, Beach, Fla., will build any type of the latest custom-made sets to order. Specializes in short wave receivers and transmitters. Service on all types of sets. Authorized Silver-Marshall and Hammarlund-Roberts Service Station.

No. 283—Authorized Hammarlund-Roberts radio-trician in Ft. Pierce, Fla., can build to order any make of set, electric phonograph, or combination. Have you a fine old piece of furniture in which you would like to install a modern set?

No. 285—Setbuilder in Jacksonville, Fla., will build any type of set to suit your taste. Aero short wave sets and converters a specialty. Only the best parts on the market used.

No. 291—Certified radio-trician and authorized Silver-Marshall Service Station in Jacksonville, Fla., will build any set or power pack, power amplifier or public address system to order.

No. 305—Setbuilder in Manatee, Fla., has Hammarlund-Roberts Hi-Q 6 receiver ready to go in a cabinet for sale. Perfect reproduction and distance getter, fully tested and tuned.

No. 366—Setbuilder in Miami, Fla., will repair A.C. or battery operated sets. Will build any set you desire from reputable manufactured parts with a guarantee of satisfaction at reasonable prices.

No. 300—Setbuilder in Oneco, Fla., will wire to your specifications all standard kits or special hook-ups.

No. 540—Expert radio-trician in Idaho Falls, Idaho, will build short wave receivers. Hammarlund-Roberts Hi-Q receivers a specialty. We repair, install and service sets. Authorized Hammarlund-Roberts radio-tricians.

No. 140—Custom made radio receiving sets employing such circuits as Remler, Browning-Drake and other high grade receivers built by setbuilder in Champaign, Ill. Lowest prices for quality merchandise. For sale, 5-tube radio frequency receiver, coast to coast reception, complete with accessories.

No. 142—Any make radio built to order by a setbuilder in Chicago, Ill. Only well-known and advertised parts used. Specializes in the Quadjur Six, Silver Laboratory Super and the Quadraformer Five and Six.

No. 162—Setbuilder in Chicago, Ill., specializes in Bremer-Tully Counterphase, Hammarlund-Roberts Hi-Q, short wave sets, and can build any other make of set to order. "A" and "B" eliminators also built. Guaranteed radio service on repairing, remodeling and designing.

No. 167—Setbuilders in Chicago, Ill., takes second-hand sets in trade on their wonder set, the "King Kustombuilt 10," cheap. We are pioneers in the radio business, having started as wireless operators in 1907.

No. 204—Setbuilder in Chicago, Ill., will build the Tyrman 70, Hammarlund-Roberts, Nine-in-Line, Silver-Marshall, Aero, or any high grade receiver to fit any style console or cabinet. All sets equipped with power amplification for battery or socket operation. Very selective—remarkable tone quality.

No. 248—Setbuilder in Chicago, Ill., will build Super Heterodynes of all makes and styles, also Hammarlund-Roberts, Silver-Marshall, Karas, Scott and Browning-Drake sets. Any others made to order, including power packs. Workmanship guaranteed. Installations on work free.

No. 259—Setbuilders in Chicago, Ill., have for sale the following sets and amplifiers: Hammarlund-Roberts Hi-Q, Silver-Marshall, Madison-Moore, Remler, Victoreen, Camfield, and Karas A.C. Prices on application.

No. 288—Setbuilder in Chicago, Ill., will build any make of set to order. Specializes in Hammarlund-Roberts Hi-Q Six and Thorola-Do-Nut 5. Meets actual local conditions. Distortionless, perfect reproduction of broadcastings. DX. Safe delivery of set. Guaranteed master workmanship.

No. 308—Highest class of custom sets built to your order and specifications by setbuilder in Chicago, Ill. Power amplifiers built to order. Your favorite circuit can be built to suit any size and kind of cabinet. Specializes in Super-Heterodynes.

No. 310—Setbuilders in Chicago, Ill., will build 1 types of sets to order. Estimates furnished. Authorized Service Station for Tyrman, Silver-Marshall, Halldorson, Aero Products, Hammarlund-Oberts, and H. F. L.

No. 334—Custom setbuilder in Chicago, Ill., will build sets to your order. Specializes in 5-tube sets embodying a tuned band pass filter. 50% deposit on all orders. Experimental sets made.

No. 338—Professional setbuilder in Chicago, Ill., with six years' experience, will build any circuit; best parts only. Specializes in H.F.L. Isotonic and Scott's Shield Grid Super. One year guarantee and service anywhere in Cook County.

No. 341—Setbuilder in Chicago, Ill., will build to order any sets or power-packs. Assembling and wiring free of charge. Also servicing and repairing old sets.

No. 380—Setbuilder in Chicago, Ill., will build custom built sets of any design for A.C., battery or eliminator operation.

No. 383—Super-Heterodyne specialist in Chicago, Ill., invites anyone in or near Chicago interested in distance reception to call and take an air tour with him from coast to coast and Canada to Mexico, using a standard receiver which he builds to order. Any set built or repaired.

No. 387—Setbuilder in Chicago, Ill., will build to order and repair any Silver-Marshall set and power pack. All workmanship guaranteed. Specializes in the Nakken Ultra Five using Silver-Marshall parts. Authorized Silver-Marshall Service Station.

No. 400—Custom setbuilder in Chicago, Ill., will build receivers from any kit using only specified parts. Specializes in Hammarlund-Roberts Hi-Q, Scott's World's Record Super, Aero Seven, Karas and short-wave sets. Workmanship and performance guaranteed. Prices reasonable.

No. 422—Professional set designer in Chicago, Ill., will rebuild old receivers in the modern way. Any make receiver built to suit any choice of cabinet. Special discounts to readers of this magazine. Power amplifiers, Scott's Shield Grid 9, and the Isotone a specialty. Demonstrations. Hear and be convinced.

No. 459—Efficient radio engineers in Chicago, Ill., will build, rebuild or remodel any set on the market today. Specializes in Transoceanic Phantom, Tyrman, H. F. L. Isotone, television and short wave sets. Established since 1921. Complete testing laboratory.

No. 462—Professional setbuilder in Chicago, Ill., specializes in Super-Heterodyne circuits. Authorized Silver-Marshall and H. F. L. Service Station. All sets constructed in an up-to-date equipped laboratory. Will service all makes of sets.

No. 474—Custom setbuilder in Chicago, Ill., has the facilities for building, repairing and testing Silver-Marshall sets, power units, amplifiers and other apparatus. Any set, eliminator or power pack built or repaired. All work guaranteed. Authorized Silver-Marshall Service Station.

No. 481—Custom radio setbuilders in Chicago, Ill., specialize in Isotone 10, Scott Shielded Grid 9, Tyrman 80-72, Lincoln 8-80, Silver-Marshall line, and Robertson-Davis Automatic Super, all guaranteed to cut through locals and get DX like original laboratory models. Guaranteed and serviced for one year.

No. 486—Custom setbuilder in Chicago, Ill., specializes in Silver-Marshall, Hammarlund-Roberts and H. F. L. Isotone sets. All types of sets built, rebuilt, remodeled and repaired. All complete kits and accessories for sale. Authorized Silver-Marshall Service Station.

No. 497—Authorized Silver-Marshall radio-trician in Chicago, Ill., will build any make of set to order in cabinet or console models. Silver-Marshall sets and power units a specialty. All receivers are guaranteed for one year against any electrical and mechanical defects, except tubes. Endorsed by Radio Association of America.

No. 498—Custom setbuilder in Chicago, Ill., will build any Silver-Marshall set and power units to order. Work guaranteed. Will ship anywhere C. O. D. Will demonstrate anywhere in Chicago or vicinity. Authorized Silver-Marshall Service Station.

No. 509—Setbuilder in Chicago, Ill., specializes in bringing your old set up-to-date such as rewiring for A.C. operation using A.C. tubes. Will install all types of power amplifiers and build A-B-C power packs for all sets.

No. 311—Setbuilder in Decatur, Ill., is in a position to build any kind of set desired. The famous Strobodine in beautiful burled walnut cabinet built of all specified parts for sale. Guaranteed mechanically perfect and built by an expert who knows Super-Heterodynes.

No. 169—Custom setbuilder in East Moline, Ill., specializes in S-M products. All orders received from this ad for S-M products will be assembled and wired free of charge and sent to you post paid. Also have an A.C. 8-tube set in table model or cabinet console fully shielded for sale. Official Silver-Marshall Service Station.

No. 406—Setbuilder in Fiatt, Ill., has one 4-tube set with three UX201-A tubes and one UX171 tube for sale. Silver-Marshall Screen Grid Fours a specialty. Other types of sets also made to order.

No. 448—Professional setbuilder in Fulton, Ill., will build any set to order. Workmanship and performance absolutely guaranteed perfect. No construction charge. Prompt delivery. Shield Grid sets a specialty.

No. 295—Setbuilder in Glenview, Ill., has for sale a B.T. 5-tube set, wonderful tone, fair distance, 3 jacks, ear phones, speaker and extra loud speaker. Plain hardwood cabinet. Also All-American 3-tube reflex. Will build any set to order.

No. 315—Setbuilder in Lena, Ill., can build any make of set to order. Has 5-tube tuned radio frequency sets with very good tone and excellent selectivity for sale.

No. 485—Custom setbuilder in Malta, Ill., will build any Silver-Marshall set ordered, for the retail price of the parts used. Business done on a cash in advance basis. References furnished on request. Any radio serviced or rebuilt. Five years' experience. Authorized Silver-Marshall Service Station.

No. 421—Custom setbuilder in Midlothian, Ill., will build, repair, remodel, and install any radio set or power amplifier. Authorized Silver-Marshall Service Station. Everything in radio fully guaranteed. Best quality. Lowest prices.

No. 412—Setbuilder in Ontarioville, Ill., will build any type of set to order and guarantee to please you. Can also build experimental television apparatus. Can repair any type of set. Also test and rejuvenate tubes.

No. 507—Radio-trician in Peoria, Ill., builds sets from any standard kits. Also short wave sets, television, power packs, and amplifiers. Silver-Marshall and Hammarlund-Roberts Service Station. All work guaranteed.

No. 464—Custom setbuilder in Polo, Ill., will build any receiver described in Radio Listeners' Guide and Call Book at list price of parts. Specializes in Silver-Marshall Shielded Grid Six, Browning-Drake sets and Silver-Marshall A-B-C power packs. Repairing a specialty. All work Sterling tested and guaranteed. Authorized Silver-Marshall Service Station.

No. 209—Setbuilder in Springfield, Ill., will build to order from practically all standard kits, both sets and power packs.

No. 505—Custom setbuilder in Springfield, Ill., can build any type of set or circuit to suit. Will also service and repair any make or type of radio power units, or speakers. Parts matched to laboratory instruments. Satisfaction guaranteed. Authorized Silver-Marshall Service Station.

No. 137—Setbuilder in Stockton, Ill., has five, six and seven-tube sets that have the promised ten kilocycle sharpness with the new shielded grid tubes. Silver-Marshall Shielded Grid Six specialty. Can build any make of set to order. Last word in up-to-minute reproducers.

No. 546—Setbuilder in Waukegan, Ill., will build any set, battery or A.C., with any number of tubes. All work guaranteed.

No. 335—Setbuilder in Wheaton, Ill., specializes in the Air Scout Four receiver as described in the Spring 1928 edition of Radio Listeners' Guide and Call Book. Will build any one, two, three, four or five tube set; also crystal sets and short-wave adaptors.

No. 362—Setbuilder in Albany, Ind., will build all makes of sets to order. Will also repair any make of set. All work and repairs guaranteed.

No. 145—Setbuilder in Elkhart, Ind., wants to build your next set for you. Madison-Moore and Diamond of the Air are specialties. Will guarantee you more for your money. Also expert repairing and rebuilding. Prices are very reasonable.

No. 143—Custom setbuilder and radio doctor in Emerson, Ind., specializes in Karas Equamatic, Tyrman 70 and Scott Shielded Grid Nine sets. Will also build any type of reliable set desired. Satisfactory results guaranteed.

No. 425—Setbuilder in Gary, Ind., will build to order any make of set you choose. Five years' experience enables me to fully guarantee all work. Specialist in Sargent-Rayment Seven and new Robertson-Davis Automatic Super-Six with push button control. Servicing and repairing also a specialty.

No. 433—Setbuilder near Harrodsburg, Ind., can build any type of radio from one to five tubes. 50% deposit on all orders.

No. 181—Setbuilder in Indianapolis, Ind., is specialist on A.C. and shielded grid tube sets. Will build to your order a set from any nationally advertised kits with parts specified by designer of circuit. Guaranteed workmanship at reasonable prices.

No. 327—Eventually you will own a custom-built Super-Heterodyne. Buy this set from a Super-Heterodyne specialist in Indianapolis, Ind. Nine years' experience and personal service. Authorized Silver-Marshall Service Station.

No. 371—Custom setbuilders in Indianapolis, Ind., will build and rebuild all A.C. and D.C. sets, amplifiers and eliminators. Will also install our style of antenna in our locality with a two-year guarantee. Prompt service.

No. 423—Setbuilder in Indianapolis, Ind., specializes in building all Hammarlund-Roberts Hi-Q models A.C. or D.C., all models of short wave converters, Tyrman 60 and 70, and the Imperial 80. Will build any type of receiver to order.

No. 463—Custom setbuilder in Indianapolis, Ind., will build, install, service and repair radio receiving sets. Power units and power amplifiers custom built. Authorized Silver-Marshall Service Station. Silver-Marshall sets a specialty. Will build and repair any type of set. Estimates gladly furnished.

No. 402—Custom setbuilder in Lapel, Ind., will build or rebuild any type of receiver. All A.C., battery or power pack installations. Any circuit and any number of tubes built from best grade parts. Neat factory-built appearance. Any type cabinet or console. Workmanship and performance guaranteed.

No. 413—Custom setbuilder in Linton, Ind., can build any type set or power pack to order. Specializes in Hammarlund-Roberts Hi-Q Six A.C. or D.C. Can change D.C. sets to A.C. operation.

No. 186—Setbuilder in Muncie, Ind., specializes in Silver-Marshall Six with the new shield-grid tubes and 210 power tube. Highest quality workmanship only.

No. 166—Setbuilder in Richmond, Ind., specializes in the complete Silver-Marshall line. Sets completely built, and sold for standard nationally advertised prices of kits alone. No construction charge. Each set tested and results sent with set. 24-page S-M catalog sent free.

No. 261—Setbuilder in Burlington, Iowa, will rebuild or make any set to order. Specializes in four and five tube sets employing regeneration. Expert repair service on all makes of sets. Satisfaction guaranteed.

No. 369—Custom setbuilder in Cedar Rapids, Iowa, with three years of actual experience will make to order or rebuild any kind of set. Specializes in Victoreen Super-Heterodyne—A.C. or D.C.

No. 455—Setbuilder in Clear Lake, Iowa, will build to order any make or type of radio receiver, A-B-C eliminator or power pack. Hammarlund-Roberts receivers a specialty. All makes of receivers repaired. All work guaranteed. Endorsed by the National Radio Institute, Washington, D. C.

No. 499—Setbuilder in Conrad, Iowa, builds sets to order. Is graduate of Radio Association of America. All work guaranteed. Will repair any type of radio. Authorized Silver-Marshall Service Station.

No. 208—Setbuilder in Council Bluffs, Iowa, has Bremer-Tully Power Six and World's Record Super 10 sets for sale with or without accessories. One to fourteen tube sets, any make, built to your order.

No. 269—Setbuilder in Des Moines, Iowa, will build any set described by the Radio Listeners' Guide and Call Book. Prompt and reliable service on any make of radio or eliminator.

No. 437—Setbuilder in Des Moines, Iowa, will construct anything you desire. Years of experience. Satisfaction guaranteed.

No. 526—Custom setbuilder and authorized Silver-Marshall service representative in Des Moines, Iowa, specializes in custom built superheterodyne, shield grid sets and power amplifiers, also rebuilding present sets to improve tone quality. All work is thoroughly guaranteed and reasonably priced.

No. 257—Authorized Silver-Marshall and Hammarlund-Roberts Service Station in Dubuque, Iowa, builds all Silver-Marshall receiving sets, power amplifiers and unipacs. Will also build 1929 model Hammarlund-Roberts Hi-Q receivers, or any circuit described in Radio Listeners' Guide and Call Book.

No. 317—Custom setbuilder in Greene, Iowa, will build any set to order. Power units and power amplifiers custom-built. Authorized Silver-Marshall Service Station. Will also service any radio set or eliminator. All work absolutely guaranteed.

No. 273—Setbuilder in Iowa City, Iowa, will build to order the Diamond of the Air, four and five tubes, and the Air Scout 4-tube receiver.

No. 404—Setbuilder in Knoxville, Iowa, will build sets from any nationally advertised kit. Specializes in Silver-Marshall sets and phonograph-radio combinations. Beautiful consoles with built-in electric phonograph, electric pick-up and any make of radio receiver desired. All work guaranteed. Can furnish cabinets, consoles, tubes, batteries, eliminators, speakers, etc.

No. 233—Professional setbuilder in McGregor, Iowa, will build sets to your specifications, using any circuit, and to fit any console or cabinet. Hammarlund-Roberts Hi-Q Six a specialty.

No. 183—Setbuilder in Newton, Iowa, offers some 5-tube T.R.F. radio sets without cabinets, wired for power tube and "C" battery. These are real volume and distance getting sets and are priced at about one-half parts price alone. Also offer complete 5-tube kits comparatively low priced.

No. 117—Setbuilder in Red Oak, Iowa, builds all high grade receivers using standard make parts throughout. Will repair any make set, factory or custom built. Specializes in Bremer-Tully Power Six and R. C. A. III 2-tube portable weighing 28 lbs. complete.

No. 298—Setbuilder in Tama, Iowa, has Silver-Marshall Shield Grid Sixes and all S-M products for sale. One year guarantee. Endorsed by National Radio Inst., Washington, D. C.

- No. 374—Setbuilder in Coffeyville, Kans., builds any type of receiver to order. Specializes in six tube and short-wave sets. Two on hand.
- No. 538—Custom radio engineer in Hutchinson, Kans., builds all apparatus from one tube sets to largest super-heterodynes and all power amplifiers. Specializes in Silver-Marshall receivers. All orders filled within ten days. Authorized Silver-Marshall Service Station.
- No. 252—Seven years' radio experience enables custom setbuilder in Kansas City, Kans., to offer custom built sets that will surprise you in their marvelous operation regardless of their low prices. We specialize in Shielded Grid receivers. We quote prices on any set.
- No. 431—Setbuilder in Kansas City, Kans., builds any set you desire in the most expert manner. Specializes in Silver-Marshall sets. Am authorized Silver-Marshall Service Station for this territory. One coast-to-coast Shield Grid 4 for sale.
- No. 506—Setbuilder in Randolph, Kans., will build any of the popular circuits to order. Will also repair any make of receiver. All work guaranteed. Eight years' radio experience.
- No. 282—Custom setbuilder in Wellington, Kansas, will build any size set or power supply to your specifications. First class workmanship guaranteed. Victoreen Supers and power supplies our specialty. Can furnish parts if desired. Prices and references on request.
- No. 381—Custom setbuilder in Middlesboro, Ky., will guarantee every part of complete set (except tubes) for one year on any circuit. Short-wave receivers and transmitters built and only the best parts used. Guarantee volume and tone. All sets tested. Experience since 1908 continually. All shipments C. O. D. Satisfaction or your money back.
- No. 301—Custom setbuilder in New Orleans, La., will build any type radio set to order.
- No. 491—Authorized Silver-Marshall Service Station in New Orleans, La., will build any Silver-Marshall set and guarantee satisfaction. Specializes in 720 Screen Grid Six. Will service and repair all makes of receivers. Endorsed by the National Radio Institute of Washington, D. C.
- No. 503—Setbuilder in New Orleans, La., will build any type of receiver with really fine quality together with the very latest advances in radio to order. All work guaranteed. Authorized Silver-Marshall Service Station.
- No. 128—Setbuilder in Shreveport, La., will build any set. Specializes in 5 and 6 tube circuits. Estimates given. We guarantee results.
- No. 111—Custom setbuilder in Battle Creek, Mich., specializes in Silver-Marshall kits. Silver-Marshall Service Station. Can build anything you want. Work reasonably guaranteed.
- No. 415—Setbuilder in Bridgeport, Mich., has Tyrman 70 sets for sale, and builds all makes of sets. You name it, we build it.
- No. 184—Setbuilder in Detroit, Mich., has for sale a 9-tube Lincoln Super complete. Specializes in any Super. Guarantee satisfaction or money refunded. \$200 in bank your protection.
- No. 190—Setbuilder in Detroit, Mich., will build any set described in Radio Listeners' Guide and Call Book. Six years' experience. Specialist on Scott's World's Record Supers 8-9-10, Nine-in-Line, Shielded Grid Six and Hi-Q Six. All work guaranteed. Any set tailored to your order.
- No. 244—Setbuilder in Detroit, Mich., has 6-tube Superphonic sets for sale. Complete line of tubes and accessories. Sets built to order. Sets repaired, altered and serviced. Prompt service.
- No. 279—Setbuilder in Detroit, Mich., will make sets to order and install them in your Victrola or any antique furniture as writing desks, book-cases or cabinets.
- No. 307—Designer and setbuilder in Detroit, Mich., specializes in short wave receivers. Will design or build to order any make of sets for any waveband.
- No. 465—Setbuilder in Detroit, Mich., will build the Hammarlund-Roberts Hi-Q 29 A.C. or battery operated set.
- No. 553—Professional setbuilder and technician in Detroit, Mich., will build any receiver, amplifier or public address systems to order. Authorized Silver-Marshall and Hammarlund-Roberts Service Station.
- No. 348—Community setbuilder in Flint, Mich., builds any set to order. Utmost satisfaction assured. Day or night radio service. Many years experience.
- No. 420—Setbuilder in Gladwin, Mich., will build any battery operated set to order. Can also furnish any manufactured A.C. or light socket operated set. Repairing done on all kinds of sets.
- No. 466—Professional designer and custom setbuilder in Grand Rapids, Mich., will build all high grade receivers, power-packs and amplifiers. Master craftsmanship. Graduate radio-trician. All sets guaranteed. Authorized Silver-Marshall Service Station.
- No. 296—Setbuilder in Jackson, Mich., specializes in such sets as Magnaformer, Harkness Counterfonic, Peridyne and S-M Shielded-Grid Six. Satisfaction guaranteed. Supplies and aeri-als installed.
- No. 561—Custom setbuilder in Lansing, Mich., will build any type of special set upon order. Specializes in Tyrman and Silver-Marshall sets. Authorized Silver-Marshall Service Station. No order too large or too small.
- No. 223—Setbuilder in Manton, Mich., specializes in Silver shielded grid sets. Can make any other kind of set to order.
- No. 379—Authorized Silver-Marshall Service Station in Port Huron, Mich., will build any type of set desired. Specializes in Silver-Marshall, Remler and Browning-Drake. Technical laboratory service in remodeling or repairing any set. Fifteen years' technical experience. Will build any type of eliminator, power amplifier or power pack.
- No. 535—Custom sets built to suit your needs and desires by setbuilder in Saginaw, Mich. Shielded Grid sets and Super-Heterodynes a specialty. Can furnish any type of cabinet or console wanted. Five years' experience.
- No. 319—Setbuilder in Sault Ste. Marie, Mich., has Hammarlund-Roberts sets for sale. Also building and repairing of all other makes of sets. Seven years' experience. All work guaranteed.
- No. 429—Setbuilder in Sturgis, Mich., builds radio sets to order. Old radios rebuilt. Specializes in five and six-tube sets.
- No. 158—Setbuilder in Cloquet, Minn., specializes in Silver-Marshall sets, Tyrman 70 Shielded Grid Amplimax and other Super-Heterodynes. Reasonable prices. Can build any circuit desired. Also convert and service radios.
- No. 189—Setbuilder in Minneapolis, Minn., specializes in Norden-Hauck Shielded Super 10 custom built receiver. Five type UX-222 screen grid tubes are used in this ultra-powerful broadcast receiver increasing the radio frequency amplification and sensitivity over 500 times. Installation on this receiver in any part of the country.
- No. 121—Setbuilder in Stanchfield, Minn., has seven years' experience in custom setbuilding and will build your favorite set for you. Fast, modern assembly equipment used and price will please you.
- No. 555—Radio setbuilder in West Duluth, Minn., will build to order any radio receiver. Sets repaired and adjusted. Endorsed by National Radio Institute, Washington, D. C.
- No. 524—Custom setbuilder in Winona, Minn., will build all Silver-Marshall sets and power packs or any other set you wish to have built. All workmanship guaranteed. Authorized Silver-Marshall Service Station.
- No. 392—Practical certified radio-trician in Vicksburg, Miss., specializes in any standard circuit and especially those described in Radio Listeners' Guide and Call Book. Any type of receiver or eliminator built or repaired at a reasonable price.
- No. 224—Setbuilder in Denton, Mo., will build Victoreen Super and any other sets to order.
- No. 513—Authorized Silver-Marshall Service Station and expert custom setbuilder in Kansas City, Mo., will build any of the sets described in this and other radio publications. Satisfaction guaranteed. Will take in your old set as part payment.
- No. 136—Setbuilder in Memphis, Mo., has three-tube coast-to-coast receivers for sale, and specializes in this type of set. Full loud speaker volume. Can build any type of set. My best reference is satisfied customers.
- No. 339—Setbuilder in Pine Lawn, Mo., will build your favorite radio set to order. Also has Tyrman 70 for sale.
- No. 230—Custom setbuilder in St. Louis, Mo., will gladly furnish estimate of cost of constructing any type radio of recognized merit, four to fourteen tubes; also power packs and short wave receivers. Workmanship unsurpassed. Have Victoreen 8-tube super for sale.
- No. 267—Radio expert and custom setbuilder in St. Louis, Mo., will build any type set you desire. Get my price to make a Panathrope combination from your radio set and your phonograph. Can also change your D.C. battery type set to use the new A.C. type tubes. All work guaranteed.
- No. 373—Custom setbuilder in St. Louis, Mo., is experienced with A.C. circuits of any kind and especially proficient with power amplifiers of the larger and more powerful kind. Service on any make radio or amplifier. All work guaranteed for one year. Authorized Silver-Marshall Service Station.
- No. 475—Setbuilder and authorized Silver-Marshall Service Station in St. Louis, Mo., will build sets from any advertised kit. Specializes in Silver-Marshall Screen Grid sets. Service and repairing on any make of sets. All work guaranteed.
- No. 539—Custom setbuilder in St. Louis, Mo., specializes in screen grids, super-heterodynes, public address systems and high voltage power packs. Silver-Marshall and Remler parts a specialty. Authorized Silver-Marshall Service Station.
- No. 271—Setbuilder in Thayer, Mo., has a five-tube tuned radio frequency set for sale. Will also make and repair any kind of set at lowest prices. All work guaranteed.
- No. 492—Certified radio-trician in Bozeman, Mont., will build, remodel and repair all kinds of radio apparatus. Graduate of National Radio Institute. Authorized Silver-Marshall Service Station.
- No. 483—Union radio-trician in Butte, Mont., will build any circuit tailored strictly to order.
- No. 341—Setbuilder in Geraldine, Mont., will build any kit or receiver to order. Workmanship guaranteed. Specializes in Tyrman receivers.
- No. 428—Setbuilder in Hagerman, N. Mex., will construct any of the popular radio sets to order. Specializes in custom-built A.C. and D.C. receivers. Send your specifications. All work guaranteed.
- No. 405—Setbuilder in Melrose, N. Mex., will build any make of broadcast receiver or short-wave receiver and transmitter to order. Will also build eliminators and cone speakers. Specializes in power amplifiers.
- No. 410—Setbuilder in Charlotte, N. C., specializes in Neutrodynes and other complicated circuits. All work guaranteed for one year. We do this work cheaply to help promote the idea of custom made sets.
- No. 393—Professional setbuilder in Ellenboro, N. C., makes a specialty on Silver-Marshall Shield Grid, Hammarlund-Roberts Hi-Q and World's Record Supers. Will assemble and wire any set for price of the parts and cabinet.
- No. 182—Setbuilder in Minot, N. Dak., will build any popular circuit to fit your requirements. Variety as to appearance offered. Buy a custom set adapted to the locality.
- No. 201—Setbuilder in Alliance, Ohio, with three years experience, will build any make of set to order. Specializes on Magnaformer 9-8 receivers.
- No. 206—Custom setbuilder in Canton, Ohio, specializes in Aero-Dyne Six and Seven. Will construct any standard custom set. All work guaranteed.
- No. 337—Setbuilder in Canton, Ohio, specializes on 5-tube Lynch-Hammarlund and Precision receivers. Also assemble 6-7-8 tube kits of single or dual control. Receivers only or all necessary equipment supplied at moderate price.
- No. 289—Setbuilder in Charndon, Ohio, specializes in Silver-Marshall sets. Can also build or install any make of set desired and service sets too. All work guaranteed satisfactory or money back. Get estimate before buying. Courtesy and service of the kind that builds up good will.
- No. 280—Setbuilder in Cincinnati, Ohio, will build to order all sets using the new shield grid tubes.
- No. 363—Setbuilder in Cincinnati, Ohio, has complete S-M line for sale. Will also build Tyrman, Aero, Browning-Drake, Hammarlund-Roberts and Bremer-Tully sets and power packs. Short wave sets a specialty. Television equipment also. Authorized Silver-Marshall Service Station.
- No. 368—Latest sets built and installed from 1 to 14 tubes by a custom setbuilder in Cincinnati, Ohio. Any set rewired or repaired. Magnaformer 8-9, Hammarlund-Roberts Hi-Q 6, Tyrman 7 and Silver-Marshall sets at expert service. Estimates cheerfully given.
- No. 457—Expert radio-trician and custom setbuilder in Cincinnati, Ohio, will build to your specifications any type set or power pack. Set installed in any cabinet or console you prefer. Work is guaranteed to satisfy. Endorsed by the National Radio Institute.
- No. 153—Setbuilder in Cleveland, Ohio, will build to order and repair any Silver-Marshall Shielded Grid Super-Heterodyne and Shielded Grid Sixes.
- No. 160—Setbuilder in Cleveland, Ohio, will build to order the new Browning-Drake sets. Specializes in completing the factory made kits. Satisfaction guaranteed. Moderate prices.
- No. 211—Setbuilder in Cleveland, Ohio, has for sale 4, 5 and 6-tube sets for 1, 2 or 3-dial control. Can also build any set to order.
- No. 318—Expert radio-trician in Cleveland, Ohio, will remodel and electrify any set. Radio sets built and repaired. Five-tube sets a specialty. Work is guaranteed and you get expert workmanship at a reasonable price.
- No. 438—Professional custom setbuilder in Cleveland, Ohio, will build any set to your order. Also short wave transmitters and receivers. Have had six years' training and practice.
- No. 494—Dependable radio doctor in Cleveland, Ohio, will build to order or repair any set, large or small, in the right way with parts specified by designer of circuit. Authorized Silver-Marshall Service Station.
- No. 511—Custom setbuilder in Cleveland, Ohio, has all Silver-Marshall sets and power packs for sale. Authorized Silver-Marshall Service Station.
- No. 512—Custom setbuilder in Cleveland, Ohio, has a Silver-Marshall 5-tube set for sale. Will build, assemble or wire any set to order. Old sets rebuilt to bring them up-to-date. Authorized Silver-Marshall Service Station.
- No. 531—Setbuilder in Cleveland, Ohio, will build to order any popular receiving set. Silver-Marshall Shielded Grid Six our specialty. Let us build you a real DX receiver. All work guaranteed. Only best of material used.
- No. 247—Custom setbuilder in Columbiana, Ohio, specializes in Super-Heterodynes, Browning-Drake, Hammarlund-Roberts, etc. Am capable of building any other set when ordered. I build custom built sets which give custom built results.
- No. 170—Setbuilder in Columbus, Ohio, will build all latest circuits, Hi-Q Six, Hot-Spot, 14, Nine-in-Line, etc. Sets made A.C. or D.C.
- No. 501—Custom setbuilder in Columbus, Ohio, specializes in custom setbuilding from Silver-Marshall products. Will also build, service or repair any circuit desired. All work guaranteed. Authorized Silver-Marshall Service Station.

No. 385—Custom setbuilder in Dayton, Ohio, will build any kind of radio set with a guarantee that counts.

No. 177—Custom setbuilder in Fostoria, Ohio, authorized Hammarlund-Roberts radio-trician. The best in radio must be custom built. Write for literature or demonstration. Any receiver, in any furniture, built to your order.

No. 565—Setbuilder in Greenville, Ohio, with twelve years' radio experience, will build any set from one to twelve tubes, A.C. or D.C. to order. Will remodel or repair your present set. Also builds short-wave and television outfits. All work neatly done and only the best parts used.

No. 469—Custom setbuilder in Lakewood, Ohio, will solve your radio troubles. Will build a custom-built receiver of great distance and tone quality. Full information mailed on request. Complete testing equipment for expert repair work on any make receiver or accessories at reasonable cost. Work guaranteed. Authorized Silver-Marshall Service Station.

No. 502—Custom setbuilder in Lakewood, Ohio, specializes in S-M 720 and short wave sets. Other makes built to order. Custom finishing and re-finishing of cabinets. Your set will be different if finished in "lace lacquer." Authorized Silver-Marshall Service Station.

No. 322—Setbuilder in Lancaster, Ohio, has Hammarlund-Roberts and Aero sets for sale. Any type of set built to order. All work guaranteed. Amplifier systems built for schools, churches, auditoriums. Also buildings wired for radio. Satisfaction guaranteed.

No. 105—Setbuilder in Malvern, Ohio, assembles, wires and constructs any make of set to order. Specializes in Silver-Marshall line. Thoroughly experienced.

No. 216—Custom setbuilder in Mansfield, Ohio, can build any set to order. Specializes in Silver-Marshall and Tyrman receivers. Have experimented with practically every type of circuit and peaker. Will also build any type power supply or radio sets. All work guaranteed.

No. 302—Setbuilder in Massillon, Ohio, makes specialty of receivers for hotels, restaurants, schools, boats, etc. In your choice of custom built sets, please expect from me choice parts and a complete set backed by experience and workmanship which has come from extensive training.

No. 504—Custom setbuilder in Massillon, Ohio, specializes in Silver-Marshall and Hammarlund-Roberts receivers installed in any type of cabinet and with electric phonograph if so desired. Demonstrations and explanations cheerfully given. Why not try a custom-built radio and be convinced as to its superiority.

No. 556—Custom setbuilder in Risingsun, Ohio, will make any set to order, repair or remodel your old battery set to operate from current. Will build or rebuild your set to fit any cabinet. All work guaranteed. Authorized Silver-Marshall Service Station.

No. 533—Radio-trician and custom setbuilder in Sandusky, Ohio, specializes in quality receivers. All work guaranteed. Recommended by the National Radio Institute. Authorized Silver-Marshall Service Station.

No. 255—Custom setbuilder in Steubenville, Ohio, builds any make of set to order, either battery or electric operated.

No. 529—Expert radio-trician in Warren, Ohio, will build any radio circuit, power unit or eliminator. Old sets taken in trade. Will repair any radio or eliminator, etc., at lowest prices. Kits and accessories at lowest prices. Authorized Silver-Marshall Service Station.

No. 549—Custom setbuilder in Picher, Okla., will build, rebuild or service any type of set. Specializes in Silver-Marshall sets. All work guaranteed. Estimates gladly furnished.

No. 403—Setbuilder in Shawnee, Okla., will build, rebuild or repair any type set desired. Special sets made to order. Ten years' practical experience. Charges reasonable.

No. 325—Radio expert and custom setbuilder in Stilwell, Okla., will build any set to order regardless of size. Electrifying and rebuilding old sets a specialty.

No. 346—Setbuilder in Sanator, S. Dak., has Silver-Marshall sets for sale. As authorized S-M Service Station, will build to your specifications.

No. 202—Custom setbuilder and radio trouble shooter in Yankton, S. Dak., will build S-M Shield-Grid Sixes or any type of set to order.

No. 369—Setbuilder in Winner S. Dak., will build sets from any nationally advertised kit. Specializes in Silver-Marshall, Victoreen and Diamond 4 and 5-tube sets, A.C. or D.C. Any make of set repaired and rebuilt.

No. 168—Setbuilder in Chattanooga, Tenn., builds any kind of set or eliminator. Old sets rebuilt or brought up-to-date; adaptation from battery to light socket operation.

No. 275—Setbuilder in Chattanooga, Tenn., specializes in Hammarlund-Roberts receivers or will build to order any other make of set. All make of sets serviced.

No. 351—Setbuilder in Alice, Tex., has Counter-phase Power Six in scroll work cabinet hand made compartment for batteries, tubes, meter, etc. Will sell special horn for cash. Will build any kind of set with or without cabinet from 3 to 10 tubes.

No. 130—Any set described in popular radio magazines built to order by custom setbuilder in Baumton, Texas. Also power amplifiers. Local installation free.

No. 161—Setbuilder in Fort Worth, Texas, has 5-tube resistance coupled Radio Broadcast Universal receiving set for sale. Can build any make of set to order. Specialize in Browning-Drake receivers.

No. 489—Custom setbuilder in Fort Worth, Tex., specializes in S-M sets but will be glad to furnish estimate on other types of sets. Real scientific repair service on any radio receiver—no guess work. All work guaranteed. References given. Authorized Silver-Marshall Service Station.

No. 292—Professional setbuilder in Harper, Tex., can build any make receiver from a one-tube set to a thirteen-tube Super-Heterodyne; the Rolls Royce of reception. Six years' experience.

No. 150—Short wave tuners and receivers built to order by a setbuilder in Houston, Texas. Specializes in Silver-Marshall Shielded Grid Six and Laboratory Super. Satisfaction guaranteed or no pay. Lowest possible prices consistent with good work.

No. 397—Setbuilder in McGregor, Tex., will build the Air Scout Four or Lynch-Hammarlund Five to order. Extra A-B-C unit to make either of these two sets all-electric. Both guaranteed.

No. 449—Custom setbuilder in Terrell, Tex., will build and install any type of set according to your specifications. Only the best parts are used. Prices are very reasonable.

No. 309—Setbuilder in Bethel, Vt., will build any set to order with or without cabinet, tubes and accessories. Will ship same within one week.

No. 361—Custom setbuilder in Norfolk, Va., with five years' experience, will construct any type set at a reasonable price and give written guarantee for satisfactory performance. Estimates gladly furnished.

No. 218—Setbuilder in Richmond, Va., offers exceptional service in designing and building special sets to suit individual needs. All types of sets serviced and repaired. Specialist on Super-Hets. Let's get together and build that DX set you've always wanted.

No. 286—Setbuilder in Richmond, Va., will build any set from three tubes to a World's Record Super 9 and 10 tubes. Estimates cheerfully given.

No. 157—Setbuilder in St. Charles, Va., has 6-tube Bremer-Tully Power Six receivers for sale. Will build any set from one to fourteen tubes on order. All work first-class and guaranteed. Six years' experience in building radio receivers.

No. 563—Certified radio-trician in Rutland, Vt., will build, repair and service radio receivers at reasonable prices. Authorized Silver-Marshall Service Station. Television apparatus, power packs, eliminators and power amplifiers custom-built to order. Specializes in Supers and Screen Grid circuits. Complete laboratory testing equipment. All work guaranteed.

No. 108—Custom setbuilders in Washington, D. C., specialize in one of the greatest all-electric A.C. receivers one could wish to hear. Distance, tone, selectivity and ease of operation, combined with a feature entirely new, press a button and get your station. Just two years ahead of times.

No. 496—Graduate certified radio-trician in Washington, D.C., will build and repair all types of sets at rock bottom prices. Satisfaction guaranteed or money cheerfully refunded. Have for sale 1928 Silver-Marshall Screen-Grid Super-Heterodyne fully guaranteed. Authorized Silver-Marshall and Hammarlund-Roberts Service Station.

No. 215—Authorized Hammarlund-Roberts radio-trician in Hollidays Cove, W. Va., will build and repair all makes of receivers and will convert any type battery set to A.C. electric sets. Also have 6, 7 and 8 tube receivers for sale, A.C. or D.C. operated.

No. 414—Setbuilder in Huntington, W. Va., builds all kinds of sets, eliminators and audio amplifiers, etc., at reasonable prices. Authorized Silver-Marshall Service Station. Have Melo-Heald Eleven equipped with Temple Senior drum speaker, Silver-Beauty "A" eliminator and Burns "B" eliminator on hand for sale.

No. 419—Setbuilder in Kingmont, W. Va., builds and repairs all kinds of sets. Also sets and speakers tested free for my customers. Short wave receivers a specialty. Old sets rebuilt or repaired at the lowest possible prices. All work guaranteed to give perfect satisfaction. Graduate of several radio courses.

No. 451—Setbuilder in Philippi, W. Va., will build any set for list price of parts. Authorized Silver-Marshall Service Station. Short wave sets and transmitters built to order. Will repair any make of set.

No. 519—Authorized Silver-Marshall Service Station in South Charleston, W. Va., will build any nationally advertised receiver, power amplifier or power pack. Specializes in screen grid super-heterodyne construction. I am equipped to accurately analyze and service any type of receiver.

No. 541—Authorized Silver-Marshall service man in Fond du Lac, Wis., specializes in Silver-Marshall radio equipment for all purposes. Will build any other set the way you want it. Expert radio service anywhere. Work endorsed by National Radio Institute, Washington, D. C.

No. 234—Setbuilder in Hustisford, Wis., specializes and has for sale A.C. or D.C. operated 6-tube one-dial radio frequency sets. Will build and repair any make of set.

No. 171—Setbuilders in Milwaukee, Wis., will build any set to suit individual taste. Specializing in Hammarlund-Roberts Hi-Q Six, Browning-Drake, Tyrman Amplimax 70, Nine-in-Line and radio cabinets and consoles. Satisfaction guaranteed.

No. 188—Setbuilder in Milwaukee, Wis., has 5-tube Karas Equamatic for sale. Will build any make of set (preferably of the neutrodyne type).

No. 222—Setbuilder in Milwaukee, Wis., will construct any set desired from one to fourteen tubes and build it into any cabinet, console or desk you wish. Speakers and amplifiers built. Satisfaction guaranteed or your money refunded.

No. 238—Custombuilt is invariably the reply when you ask what set have you that enables you to get such phenomenal results? Setbuilder in Milwaukee, Wis., will bring the world to your fireplace with a custom built receiver placed in the type of cabinet or console you like best. Installation and service in and near Milwaukee.

No. 266—Setbuilder in Milwaukee, Wis., specializes in building Silver-Marshall sets and has same for sale. Any make of set built to order. Expert work in building, repairing and servicing custom-built sets. Authorized Silver-Marshall Service Station.

No. 349—Setbuilder in Milwaukee, Wis., will build any radio set to order. Graybar-Western Electric Headquarters.

No. 353—Custom built radio receivers of unexcelled quality, built by setbuilder in Milwaukee, Wis. Specializes in Hammarlund-Roberts Hi-Q, Tyrman 70 and Lynch-Hammarlund; shield grid tubes employed. Special amplifiers and power packs built and installed. What are your needs?

No. 450—Custom setbuilder in Milwaukee, Wis., will build or service any make of set. Specializes in Silver-Marshall sets and power packs. All work guaranteed. Authorized Silver-Marshall Service Station.

No. 135—Setbuilder in Monomonic, Wis., will build any set with 10% cash discount. Each set carries a guarantee for one year free service, express prepaid. Laboratory tested Super-Heterodynes our specialty.

No. 558—Authorized Silver-Marshall Service Station in Racine, Wis., has facilities for building or repairing Silver-Marshall sets, power units, amplifiers and other apparatus. Will build, rebuild or repair any type set desired. All work guaranteed.

No. 342—Authorized Silver-Marshall Service Station in Wauwatos, Wis., builds any set to order, but specializes in Silver-Marshall 720 kits. These sets built for list price of parts. 50% deposit to accompany each order.

**PACIFIC STATES**  
**Arizona, California, Colorado, Nebraska, Oregon, Utah, Washington**

No. 212—Setbuilder in Ajo, Ariz., specializes in the new Silver-Marshall 720 Screen Grid Six. All sets rebuilt for A.C. References furnished. Express prepaid on all new sets. All work guaranteed.

No. 382—Setbuilder in Flagstaff, Ariz., will build and service any make of set from the biggest to the smallest. No charge made for building except the list cost of parts. Four years' real experience. Free consultation.

No. 260—Setbuilder in Phoenix, Ariz., has the following sets for sale or trade; three tuned radio frequency sets, one Browning-Drake set, one Marco-Dine set and one Aero short-wave set. These sets are built of first class material and in first class condition.

No. 537—Setbuilder in Phoenix, Ariz., will build any kind of radio set. Short wave and screen grid tube sets a specialty. No extra charge for building. You are charged only the standard national advertised prices. All work guaranteed.

No. 490—Expert professional setbuilder in Berkeley, Calif., specializes in Silver-Marshall products. All makes of sets repaired and serviced. Authorized Silver-Marshall Service Station.

No. 256—Custom setbuilder in Glendale, Calif., specializes in Bremer-Tully, Silver-Marshall and Browning-Drake receivers. Official Arcturus service station. Inquiries gladly answered without cost or obligation. Let us help you with your problems.

No. 228—Setbuilder in Hollywood, Calif., has Silver-Marshall Shielded Grid Six sets for sale. I am equipped to balance and service any make of sets. Will also build to order any and all makes of sets.

No. 220—Setbuilder in Huntington Park, Calif., will build to order Hammarlund-Roberts Hi-Q Six, H. F. L. 9, Scott's New Super 9, Silver-Marshall New 720, Television and short-wave sets. Sets built for quality and distance.

No. 522—Setbuilder in Huntington Park, Calif., will build and repair all types of receivers. All work guaranteed.

No. 185—Professional setbuilder in Los Angeles, Calif., has 6-tube Silver-Marshall Shielded Six. Specializing in this kind of set. Can build any kind of set to order. Can design cabinets or consoles to match.

No. 316—Setbuilders in Los Angeles, Calif., are specializing in Browning-Drakes, and in special sets for those who want individuality in design and appearance, together with the ultimate in performance. Such sets are engineered not "just built."

No. 418—All electric advanced type powerful Torgerson 7 tube distance receivers in walnut console cabinet for sale by setbuilder in Los Angeles, Calif. Positively unexcelled tone. Cuts through powerful locals. Fifteen hundred miles with volume. Stands voltage variations.

No. 525—Custom setbuilder in Los Angeles, Calif., specializes in short wave converters. All types of radio sets repaired, serviced, rebuilt or built to order. Operating short wave station W6DEG and W6DPW. All Silver-Marshall parts carried in stock. Authorized Silver-Marshall Service Station.

No. 210—Setbuilder in Oakland, Calif., will build any make of radio set, power pack and power equipment, all laboratory tested. Phonographs converted into electric Orthophonics. Television and short-wave receivers built. Specializes in the new S. M. Sargent-Rayment Seven with four stages of shield grid R.F.

No. 510—Authorized Silver-Marshall Service Station in Oakland, Calif., will build, repair and service any and all radio receivers of the S-M line. Also any of the S-M "B" eliminators, power packs and amplifiers. All work guaranteed.

No. 227—Setbuilder in Oildale, Calif., has Aerodyne Sixes for sale. Also make Magnaformer 9-8, and any other radio set you may wish. Mounted in any type cabinet you prefer.

No. 411—Factory trained expert designer and builder in Pomona, Calif., will design especially to suit your requirements any circuit you desire for A.C. or D.C. operation. All makes of sets rebuilt or repaired. Laboratory matching and calibrating service.

No. 564—Setbuilder in Pomona, Calif., builds Hammarlund-Roberts sets and specializes in Silver-Marshall power amplifiers. Seven years of radio experience in custom setbuilding.

No. 198—Custom setbuilder in Roseville, Calif., will build to order any make of receiver described in Radio Listeners' Guide and Call Book at list price of parts used. Workmanship guaranteed. All work Jewell tested. Specializes in Scott's World Record Supers, and Browning-Drake receivers. One year service free on sets constructed.

No. 329—Custom setbuilder in San Diego, Calif., can construct any set up to eight tubes. Aerodyne, Karas Equamatic and Knickerbocker Four a specialty. Sets complete if desired. All sets guaranteed.

No. 284—Authorized Hammarlund-Roberts radio-trician in San Francisco, Calif. is capable of building custom-built radio receivers of real merit. Specializes in the Quadruphase, Magnaformer 9-8, and Browning-Drake receivers. One year written guarantee issued with any custom built receiver. Endorsed by National Radio Institute, Washington, D. C.

No. 477—Custom setbuilder in San Francisco, Calif., will build any type of radio receiving set. Specializes in Remler No. 29 Super Infradyne and Best 115 K.C. Super. All work guaranteed for one year.

No. 542—Setbuilder in San Francisco, Calif., is fully equipped to build and service any Silver-Marshall sets, power packs, and amplifiers. Will electrify your present phonograph at a moderate price, and make your present D.C. set to A.C. Any make of sets built and repaired. Authorized Silver-Marshall Service Station.

No. 359—Custom setbuilder in Santa Ana, Calif., is authorized Hammarlund-Roberts radio-trician. Will build the Hammarlund-Roberts Hi-Q or other good makes of sets. Will repair any make of radio receiver.

No. 389—Professional custom setbuilder in Tuolumne, Calif., has laboratory for building radio sets, eliminators and amplifiers. Sets converted to A.C. Hammarlund-Roberts Service Station. Short-wave sets, inductors and transmitters built.

No. 231—Custom setbuilder in Whittier, Calif., will build any kind of broadcast receiver or short wave receiver. Will also rebuild or repair sets or remodel old battery set to A.C. operation. Specializes in 4 and 6-tube broadcast receiver of own design and the Junk Box short wave receiver. All work guaranteed.

No. 384—Setbuilder in Denver, Colo., will build you a set to suit your own ideas using any circuit. Will make any size or shape to fit in desk, phonograph, wall space, etc. Power units to match any set. Will take your old set in on a trade or bring it up-to-date for a small fee. Victoreens a specialty.

No. 174—Setbuilder in Durango, Colo., specializes in short wave sets. Will build any type short wave set and any other type of sets.

No. 356—Setbuilder in Longmont, Colo., will build any make of set to order in cabinet or console models. I have Ultradyne and Browning-Drake receivers for sale. Repair service a specialty. All work guaranteed.

No. 409—Authorized Hammarlund-Roberts radio-trician in Pueblo, Colo., will demonstrate and build sets to your order for battery or A.C. operation. Also short-wave sets and adaptors.

No. 336—Setbuilder in Albion, Nebr., has selective 5-tube set with good tonal quality for sale. Specializes in rebuilding and repairing radio sets. Can build any make of set to order.

No. 557—Expert professional setbuilder and service man in Boelus, Nebr., will build any set to order from high grade parts. Converting D.C. sets to A.C. operation a specialty. Prompt and efficient service on all sets, and good stock of standard sets, tubes, batteries and accessories on hand at all times.

No. 278—Expert professional setbuilder in Exeter, Nebr., will build any radio receiver to order. Silver-Marshall sets a specialty. Prompt efficient service. Stocks, parts and accessories. Set repairing and tube testing, service equipment and installation.

No. 345—Setbuilder in Mt. Clare, Nebr., will build any make of set for list price of parts. All types of sets serviced and repaired at small cost. All work guaranteed. Five years' experience. Have five-tube home-built Neutrodyne and 18 inch cone speaker for sale.

No. 357—The set you have always wanted—the custom built Quadraformer, made by a setbuilder in Omaha, Nebr. Also kits and parts. Must be seen to be appreciated. Will also build any set to order, and "A" and "B" power units.

No. 173—Setbuilder in Upland, Nebr., will build any set and also repair sets of all kinds.

No. 274—Setbuilder in Medford, Ore., will build and repair all types of receivers. All work guaranteed.

No. 416—Experienced custom setbuilder in Ontario, Ore., will build any type of set to order. Repairing and service. Sets adapted for light socket operation.

No. 340—Custom setbuilder in Portland, Ore., builds any radio from simplest crystal set to largest super. Now specializing on the Silver-Marshall Shielded Grid Six and Silver-Marshall All Wave Tuner.

No. 355—Setbuilder in Portland, Ore., will build any radio set to order. Satisfaction guaranteed. Specializes in Super-Heterodynes.

No. 398—Setbuilder in Portland, Ore., will build any make of radio set from one to ten tubes. Five years' experience.

No. 408—Setbuilder in Portland, Ore., specializes in Bremer-Tully and all kinds of Super-Heterodynes. Only high grade parts are used in sets and power amplifiers. Will build your set to fit your phonograph, bookcase, etc., and guarantee it to work. Eight years' experience.

No. 131—Setbuilder in Price, Utah, specializes on Infradyne and S-M Shielded Grid Six. Can build any make of set to order. Prices reasonable and all work fully guaranteed.

No. 159—Setbuilder in Oak Harbor, Wash., will build custom radio sets free. My only charge is list price for parts. Any type of set built to your order. I also design and rebuild them for any need. No set too small or too large. Free consultation.

No. 200—Setbuilder in Seattle, Wash., has radio sets that bring in the stations you want. Up-to-date sets installed in your old cabinet or console.

No. 467—Setbuilder in Seattle, Wash., has for sale 5-tube All-Electric Browning-Drake. Will rewire, repair or build any type of set or amplifier at reasonable prices. Workmanship guaranteed.

No. 213—Setbuilder in South Tacoma, Wash., has for sale all Silver-Marshall sets and power units. Any set built to order. All work guaranteed. Authorized Silver-Marshall Service Station.

No. 287—Custom built sets, laboratory built and tested on the air by setbuilders in Tacoma, Wash. Any set preferred built and guaranteed. Delivery anywhere in western Washington.

No. 518—Custom setbuilder in Thornton, Wash., will build any type of set and install it in any type of console or cabinet. Will service any make of receiver. Workmanship guaranteed. Specializes in Hammarlund-Roberts Hi-Q, Scott's World Record Super, and Magnaformer 9-8.

## CANADA

Alberta, British Columbia, Manitoba, Ontario, Saskatchewan

No. 442—Radio setbuilder in Coleman, Alberta, Canada, can save you money by building one of the modern A.C. or D.C. circuits into your old console. Shield-Grid circuits especially. Specializes in Sargent-Rayment Seven. Silver-Marshall "Round the World" set for sale; also "Coast-to-Coast Four."

No. 235—Setbuilder in New Dayton, Alta., Canada, has long distance, one, two, three, four, five, six and ten-tube sets for sale. Any make built to order. Dry or wet cell equipped. Sets installed and repaired. Work guaranteed.

No. 225—Setbuilder in Nanaimo, B. C., Canada, will build any type of receiver from complete kits. Expert work. Five years' experience. Satisfaction assured. Distance no obstacle. If you propose buying, write for information and unbiased advice on how you can have a better receiver for less money.

No. 165—Custom setbuilders in Hamilton, Canada, will build any of the popular kit sets at a very low cost. Best results guaranteed.

No. 199—Setbuilder in Winnipeg, Man., Canada, will build and repair all makes of sets. Special terms to the trade. Eight-tube Super for sale, electrified, built-in Silver-Marshall Unipac, UX-210 push-pull amplifier, complete with 3-ft. cone, built-in loop in beautiful walnut cabinet.

No. 454—Certified radio-trician in Winnipeg, Manitoba, Canada, specializes in Hammarlund-Roberts, Scott's World Record, and all makes of A.C. operated high class "A" and "B" batteries, eliminators, power packs, amplifiers, dynamic speakers, phonographs, etc. Will also test and repair all makes of sets. Complete laboratory equipment. Deposits on all orders.

No. 470—Setbuilder in Renwer, Manitoba, Canada, will build any type of radio receiving sets, speakers or eliminators to order. Estimates gladly furnished.

No. 347—Setbuilder in Montreal, Canada, features single control radio sets of five and six tubes of the most advanced designs. Also Ferranti push-pull phonograph amplifiers. Any set built to order.

No. 471—Custom setbuilder in Moncton, N. B., Canada, has complete equipment for building and repairing Silver-Marshall radio sets and power packs a d other makes of sets. Authorized Silver-Marshall Service Station.

No. 401—Custom setbuilder in Fort Frances, Ont., Canada, builds any type of set in cabinet or phonograph. Specializes in Browning-Drake, Aero and reflexes. Will supply tubes, kits and accessories at lowest prices. Prompt service.

No. 323—Setbuilder in Port Arthur, Ont., Canada, builds sets that produce results. Specializes in Quadraformer and Mercury Super-Ten. Can build any make of set to order or rebuild the old one. Workmanship guaranteed.

No. 340—Community setbuilder in Ontario, Canada, will make any set to order. Satisfaction guaranteed.

No. 193—Setbuilder in Toronto, Ont., Canada, builds all popular circuits, more sensitive, selective, powerful and cheaper than equivalent circuit in manufactured set. Specializes in 5-tube receiver which has received verifications from Cuba, Mexico and Pacific Coast.

No. 333—Setbuilder in Toronto, Ont., Canada, is specialist in all Harkness circuits, including New Shield Grid Five and counterflex circuits. Will be glad to furnish any prices and information free on request.

No. 548—Setbuilder in Toronto, Ont., Canada, will build or repair all types of receivers at reasonable rates. Can design cabinets or consoles to match.

No. 426—Setbuilder in Montreal, Quebec, Canada, specializes in Bremer-Tully, Kenneth Harkness and Silver-Marshall receivers. All first class sets built to order and serviced. Workmanship guaranteed. Graduate of Ozarka, Inc., and Radio Association of America.

No. 552—Setbuilder in Glaslyn, Sask., Canada, will build any battery operated set to order. Three years' experience. All work guaranteed. Old sets repaired. Silver-Marshall Service Station.

No. 443—Setbuilder in Hanley, Sask., Canada, specializes in 4, 5 and 6 tube sets. Any make of set built to order or will rebuild old sets up-to-date.

No. 386—Certified radio-trician in Hirsch, Sask., Canada, specializes in Hi-Q Six and Silver-Marshall custom built sets, using either regular or screen grid tubes. Short-wave adaptors built to plug in your present set. Tubes rejuvenated. Any set made to your order. Estimates given and work guaranteed.

No. 176—Setbuilder in Regina, Sask., Canada, has for sale a 4-Tube Bremer-Tully receiver and 2-tube Bremer-Tully short wave receiver (12 $\frac{1}{2}$ -200). Specializes in Bremer-Tully and Silver-Marshall sets. Any make of set built to order.

No. 226—Setbuilder in Regina, Sask., Canada, specializes in 5 and 6 tube receivers, Super-Heterodynes, power suppliers and amplifiers. Estimates gladly given on the above to suit purse, taste and location.

No. 547—Setbuilder in Regina, Sask., Canada, will build any make of radio receiver to order. Authorized Silver-Marshall Service Station. Sets serviced or installed at reasonable charges.

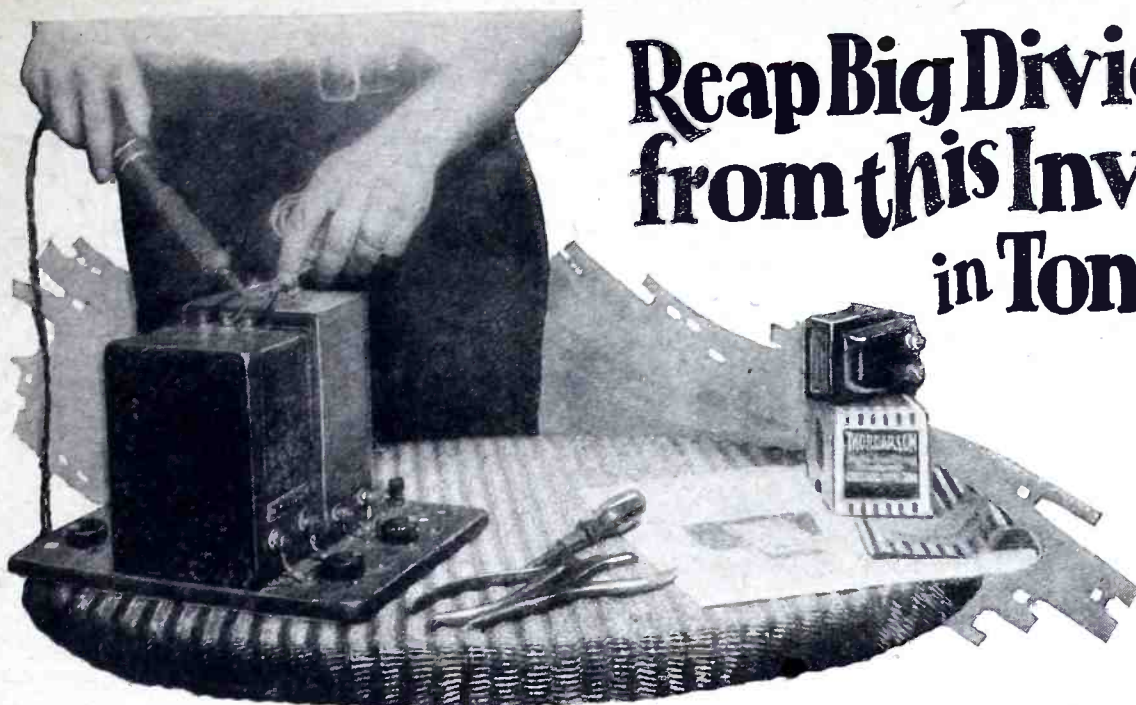
## FOREIGN

Cuba, Porto Rico

No. 447—Professional setbuilder and radio expert in Havana, Cuba, specializes in Browning-Drake one-control sets and National Shield-Grid short wave sets. Can build to order any make of set, power pack, electric phonographs and television sets. Service on all types of receivers.

No. 299—Custom setbuilder in Mayaguez, Porto Rico, has 5-tube flexible short-wave broadcast receiver for sale. Specializes in this kind of set. Can build any short-wave set to order.

No. 453—Sets built and repaired by a professional setbuilder in Guayama, P. R. Authorized Silver-Marshall Service Station. Specializes in short wave sets. Will convert all sets for A.C. operation.



# Reap Big Dividends from this Investment in Tone Quality

## A Thordarson Power Amplifier (Home Constructed) Will Transform Your Radio Into a Real Musical Instrument

WITH the insistent demand for quality reproduction, power amplification has become a vital radio necessity. Today, it is hard to find a radio set manufacturer who does not employ one or more power tubes in the output stage of his receiver.

There is no need, however, for you to discard your present radio instrument in spite of the fact that it is out-classed by newer models with power amplification. You can build a Thordarson Power Amplifier which, attached to your receiver, will provide a fullness and richness of reproduction that will equal or surpass the finest offerings of the present season.

Thordarson Power Amplifiers are exceedingly easy to assemble, even for the man with no previous radio experience. Only the simplest tools are used. Specific instructions with clear-cut photographs, layouts and diagrams insure success in home construction.

Whether your present receiver is factory made or custom built one of these amplifiers may be attached with equal ease. In fact, most Thordarson Amplifiers require absolutely no changes in

the wiring of the receiver itself, attachment being made by means of a special plug which fits the last audio socket of the receiver.

Thordarson Power Amplifiers for the home constructor and professional set builder range from the simple plate supply unit up to the heavy-duty three stage units employing the 250 type power tube in push-pull arrangement. These power amplifiers cover the requirements for every purpose and every pocket-book. They may be used with any type of horn, cone or dynamic speaker.

With a background of over thirty-three years manufacturing quality transformers, it is only natural that so many manufacturers of receiving sets of undisputed superiority have turned to Thordarson as the logical source of their audio and power supply transformers. The discriminating home constructor will do well to follow the lead of these manufacturers when buying his power amplifier.

Write to the factory today, enclosing 25c for the new "Power Amplifier Manual"—just off the press.



*New!*

No Amateur or Professional Set Builder Should Be Without This Book—

"POWER AMPLIFIER MANUAL"

A simple, yet complete, treatise on the subject of audio and power amplification, including full information on building, servicing, and testing power amplifiers in general. Also contains detailed specific construction data on twelve individual power units, with clear-cut layouts and diagrams of each.

25c

Send 25c in Cash or Stamps for This New Book—  
*Just Off the Press!*

### MAIL THIS COUPON TO-DAY!

THORDARSON ELECTRIC MANUFACTURING CO.  
500 West Huron Street, Chicago, Illinois

Gentlemen: Please send me your new "Power Amplifier Manual" for which I am enclosing 25c.

Please send me free of charge your instruction sheet on the amplifier I have checked below:

171 Single  171 Push-Pull  210 Single  210 Push-Pull (1 Stage)  210 Push-Pull (2 Stage)  250 Single (1 Stage)  250 Single (2 Stage)  250 Push-Pull (3 Stage)  210 Phonograph Amplifier

Name.....  
Street and No.....  
Town..... State.....

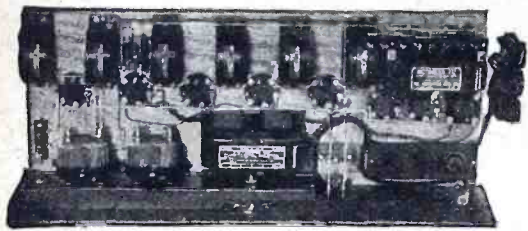
3686 N

# THORDARSON RADIO TRANSFORMERS

SUPREME IN MUSICAL PERFORMANCE

Until you have heard the  
**NEW VICTOREEN**  
"A.C." or "D.C."

You cannot realize the marvelous development in Radio Reception.



The new Victoreen is simply wonderful—that is the only way to describe it. It has wonderful tone—wonderful selectivity, wonderful sensitivity. It is wonderfully simple to assemble, wonderfully easy to operate. Anyone who has the slightest "knack" can assemble in a few pleasant hours a set which, from every standpoint, simply cannot be surpassed.

This is a season of wonderful radio programs. With a Victoreen you can enjoy them from coast to coast. If a Victoreen can't get a station it can't be had.

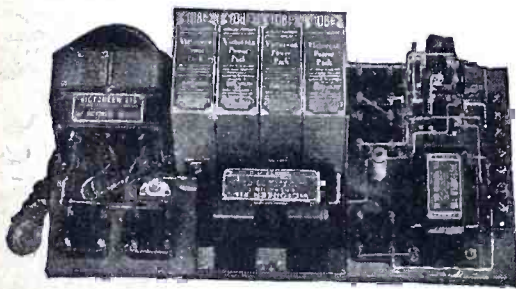
Victoreen R.F. Transformers have been greatly improved—the circuit has been still further developed—many other radical improvements have been made which make Victoreen more than ever, the world's standard "Super."

Write for the complete Victoreen story and the *FREE Blue Prints* giving constructional data and full directions. You'll have a set that you can boast about, when you have a Victoreen.

The Blue Print is FREE

State whether you are interested in "A.C." or "D.C."

**Victoreen Power Amplifier and "B" Supply**  
makes any good set better.



Supplies 45, 90, 180 and 450 volts, using a UX210 or 250 in the last stage. Contains two voltage regulator tubes so that the 90 and 180 volt taps are supplied with a constant volt potential. It is the last word in "B" supply. For the most satisfactory results you MUST have it.

FREE BLUE PRINT with list of parts and complete assembly instructions, will be sent upon request.

**THE GEO. W. WALKER CO.**  
Merchandisers of Victoreen Radio Products  
2825 Chester Ave., Cleveland, Ohio

**Victoreen**

**The S-M "Round-the-World-Four"**

(Continued from page 60)

starts at the "F" post nearest the "C" or cathode post and ends at the "P" post.

The number of turns necessary to cover the four bands from 17 to 240 meters is given below, using an S-M 317 tuning condenser of .00014 capacity and a .00035 tickler condenser.

SHORT WAVE COIL WINDINGS

SECONDARY TICKLER

Coil Number	Wire Size	No. of Turns	Wire Size	No. of Turns
131-T	No. 22 Plain Enamel	6½	No. 34 double cotton	5½
131-U		13½		5½
131-V		25½		9½
131-W	No. 24 double	49½		15½

The tuning curves for a particular set of four coils are given as an aid in finding stations when the set is first operated, and it will be seen that the amateur wave bands fall well away from the ends of the condenser scale, so that with good vernier dials no difficulty is had in tuning amateur code signals.

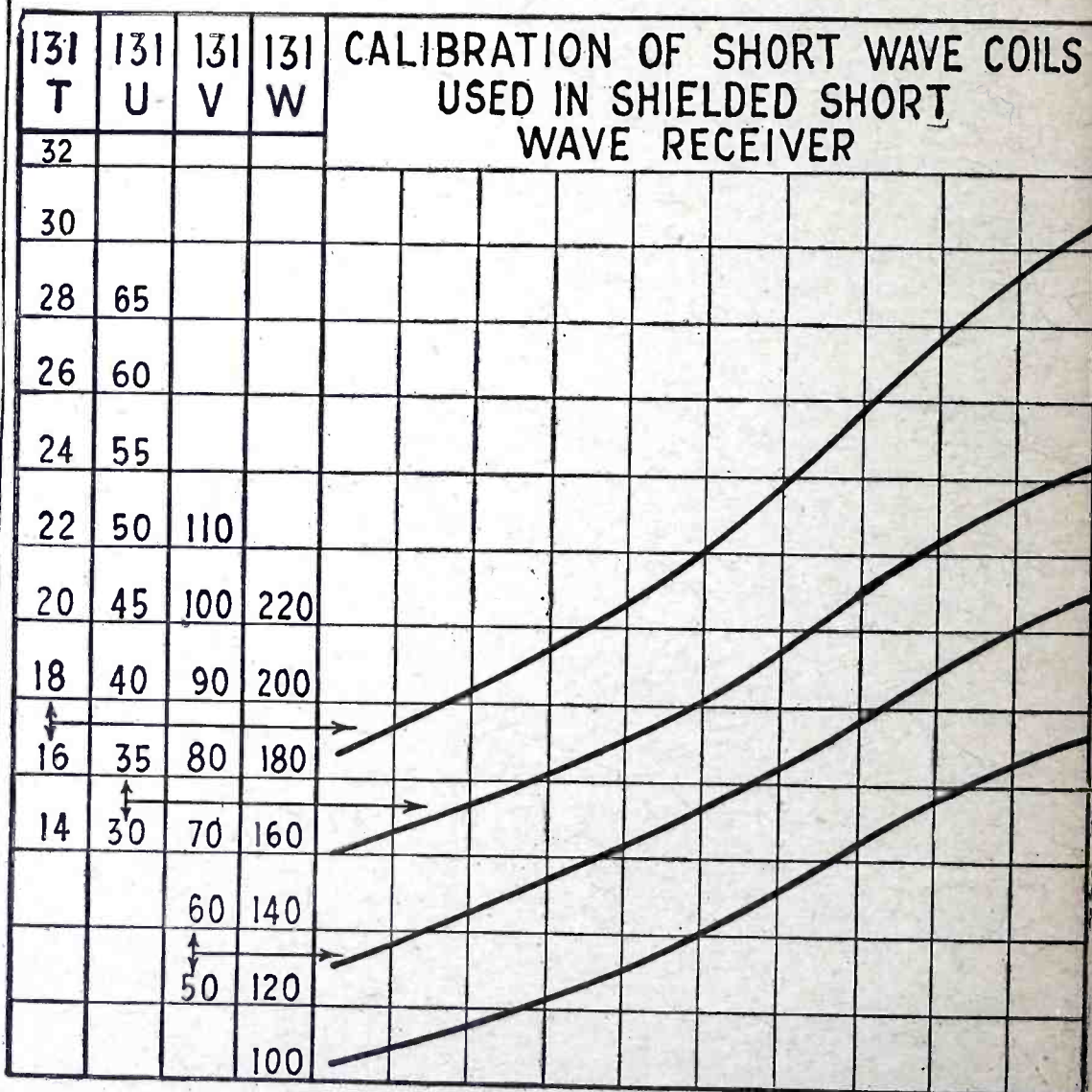
To duplicate the curves given, it may

can be quickly wound for the "Round-the-World Four."

The operation of the set is simple, almost any antenna from fifteen to fifty feet giving quite good results; even a long broadcast antenna does not seem to destroy the sweet control of the set. Any good storage battery, 9 volts of "C" battery, and 135 to 180 volts of "B" battery (or as low as 90 will do) are all that is necessary for operating power.

Eliminators are generally noisy on short waves and are not to be recommended, for the detector tube at least. Two 112-A audio tubes, a 201-A or better yet, a 112-A detector, a 222 screen-grid R.F. tube, and phones or loud speaker make up all the equipment needed to listen in on almost all of the world from England to Australia, Africa to Alaska, and back again (if reports of short waves circling the world are true). One may be certain though, of the thrill of 5,000 or 10,000 mile reception as a fairly regular thing, and will have the tried and proven performance of a good short wave receiver as a known factor to start with in the experimental reception of television.

The thrill of short wave reception can-



**RADIO LISTENERS' GUIDE and CALL BOOK DIAL DIVISIONS**

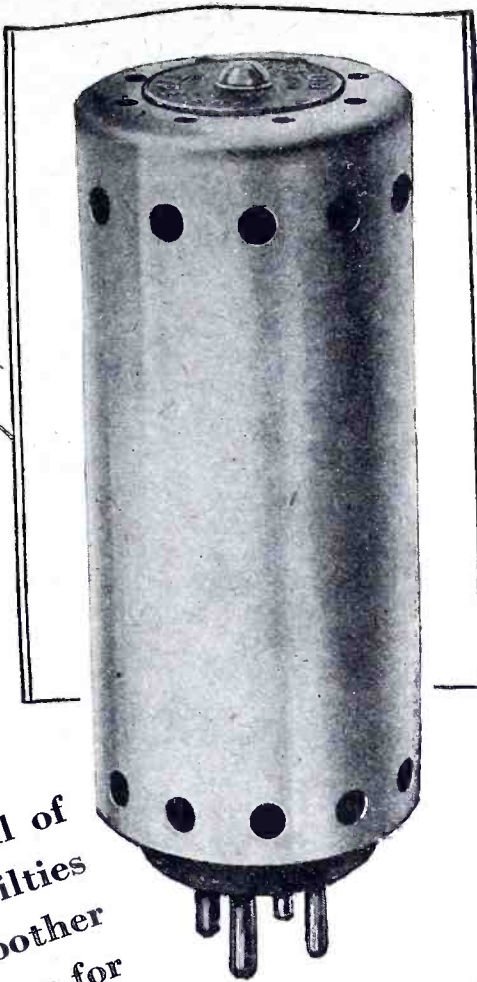
Calibration chart of short wave coils used in the S-M "Round-the-World-Four."

be necessary to trim coils a bit once they are wound, but this is easily done, or coils simply rewound on the small bakelite forms. Coils of fewer or greater numbers of turns for other wave bands,

not be appreciated until one has actually experienced the reception of signals emanating from a station located at the other end of the world. Short waves—the greatest annihilator of space.



# THE NEW 5000 HOUR ELKON METALLIC RECTIFIER FOR "B" ELIMINATORS



At last a dry high-voltage rectifier! All of the advantages of a tube—none of its frailties—much longer life—more efficient—smoother power—no noise—now as perfect a rectifier for the "B" end as the Elkon "A" Rectifier—stand-ard with "A" Eliminator manufacturers. And the Elkon Rectifiers are Self-Healing—surges or accidental overloads are automatically taken care of—no permanent injury is done.

The Elkon EBH replaces BH type tubes in "B" Eliminators. Simply take out the fragile 1000 hour tube and plug in the husky Elkon EBH 5000 hour Rectifier. Same characteristics, but what an improvement. Use the Elkon EBH Rectifier! Eliminate all uncertainty of life, of successful operation. Build your own new "B" Eliminator or convert the one you have to up-to-the-minute radio efficiency.

**ASK ABOUT THE OTHER ELKON RECTIFIERS, TOO**  
M-16 for "A" Eliminators and 3 ampere chargers.  
V-4 for trickle chargers—and the authorized Balkite Replacement Rectifiers  
BNK and BJ.

Radio Department  
**ELKON, Inc.**  
Division of P. R. Mallory & Co., Inc.  
350 Madison Ave., New York City

ELKON, Inc., Radio Department,  
Dept. E-1, 350 Madison Ave., New York City  
Kindly send me complete information on Elk-on Quality Radio Products.  
Name .....  
Address .....



# Enjoy LOUD SPEAKER OPERATION from a CRYSTAL

NO "TUBES"- NO "B" BATTERIES- NO COSTLY "ELIMINATORS"  
WITH THE  
**SKINDERVIKEN  
TRANSMITTER UNIT**

Simple microphone unit provides a most effective and inexpensive way to satisfactory speaker operation. Easy to build and operate circuit.



Everybody can do this now with a Skinderviken Transmitter Unit. The unit is fastened to the diaphragm of the speaker unit. It will act as a "microphonic relay." Every time an incoming signal actuates the diaphragm, the electrical resistance of the microphone unit will be varied correspondingly and the current from the battery, in series with it and the loud speaker, will fluctuate accordingly.

Thus the problem of securing sufficient power to actuate the loud speaker is simply and adequately solved.

The results from this very novel and simple unit will astound you.

The expense of this hook-up is trifling compared to the elaborate tube circuits that give no greater actuation of the speaker.

Besides this there are many other valuable uses in Radio Circuits for this marvelous little unit. Every builder of Radio sets should have a few on hand.

### LISTENING THROUGH WALLS

This Unit makes a highly sensitive detectaphone, the real thing—you listen through walls with ease. Plenty of fun and real detective work too.

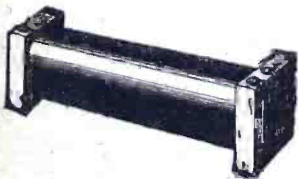
### CONDUCTING SOUND THROUGH WATER

Make yourself a miniature submarine signaling apparatus like those used during the war. Simple circuit with this microphone unit gives splendid results.

### 12-PAGE INSTRUCTION BOOKLET

containing suggestions and diagrams for innumerable uses, furnished with each unit.

### P. G. MICROPHONE TRANSFORMER



A Modulation Transformer specially designed for use with the Skinderviken Transmitter Unit. Has many other uses. Primary resistance,  $\frac{1}{2}$  ohm; secondary, 55 ohms. **\$2**

### FOR SALE AT LEADING DEALERS

Or Order Direct, Using Coupon Below

## SEND NO MONEY

When the postman delivers your order you pay him for whatever you have ordered, plus a few cents postage.

PRESS GUILD, INC. RLG-12-28  
16-18-G—East 30th St., New York, N. Y.

Please mail me at once as many of the following items as I have indicated.

... Skinderviken Transmitter Units at 95c. for 1; \$1.75 for 2; \$2.50 for 3; \$3.20 for 4.

... P. G. Microphone Transformers at \$2.

When delivered I will pay the postman the cost of the items specified plus postage.

Name.....

Address.....

City.....State.....

## The Halldorson A.C. 56 Receiver

(Continued from page 79)

it will be found that the receiver will oscillate very forcibly. Slowly slide each one of the resistances back until the os-

cillation dies away. It is advisable to do this on a station about 45 or 50 on the dial, and if care is taken in adjusting both resistances, tremendous volume will be obtained without oscillation at any point on the dial. In practice it is usually found that there is a slight variation between the resistances when adjusted. The first resistance will run in the

## The Braxton-King Shield Grid Short-Wave Set

(Continued from page 73)

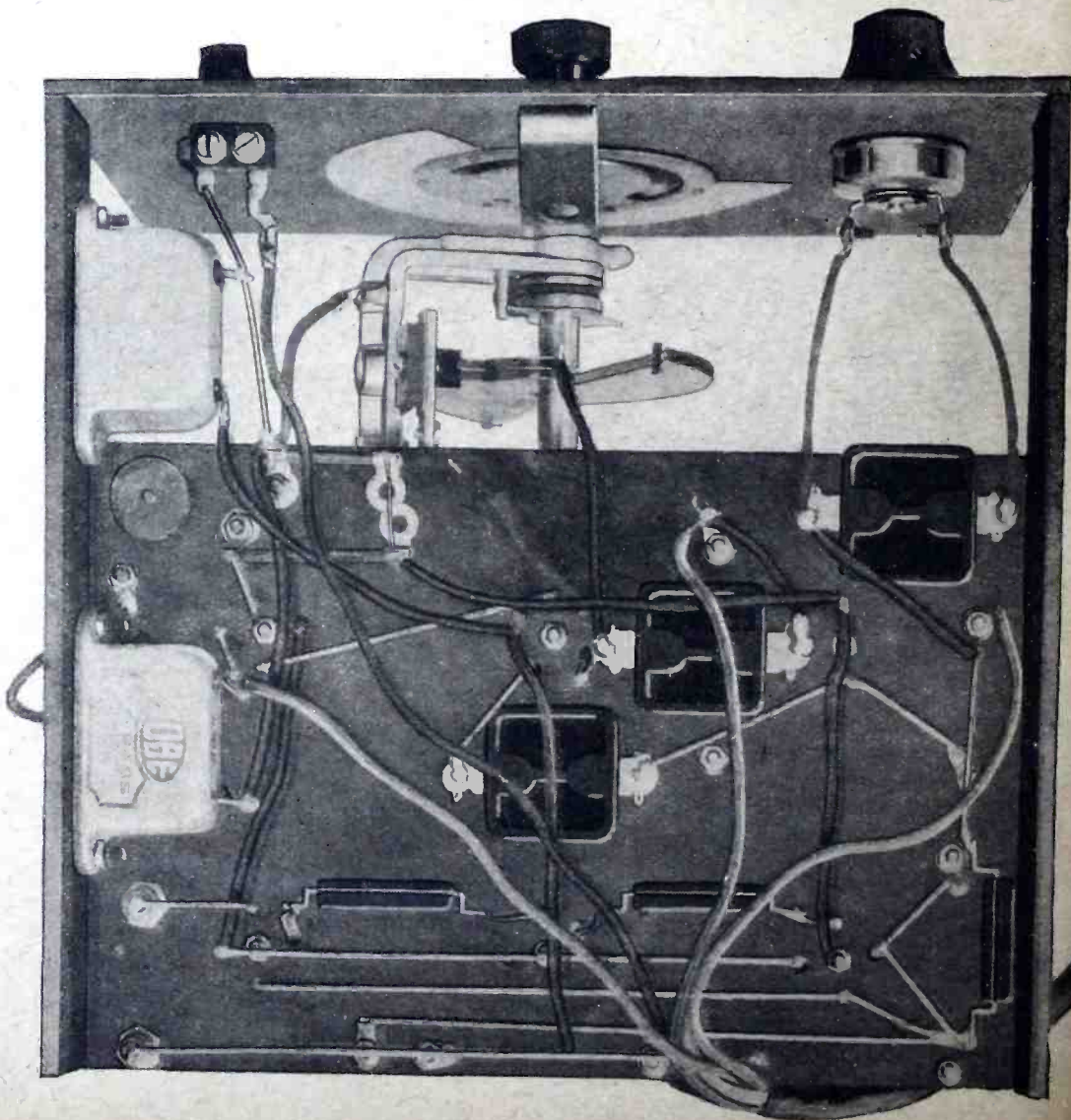
is slot wound, and the coupling is fixed, regeneration being controlled by a variable resistance in series with the B bat-

tery source. All of the coils are very rigidly constructed, and the windings and coupling cannot be injured by handling.

Note the horizontal mounting of the small by-pass condensers and the rigid bus bar wiring. The condenser lugs are attached directly to the connecting terminals, and wires fastened thereto; thus expediting wiring and assuring permanent and secure contacts.



The special power unit used in connection with the Halldorson A.C. 56 Receiver.

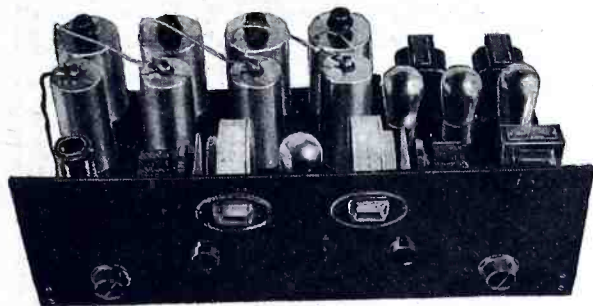


A bottom sub-panel view of the Braxton-King short wave receiver.

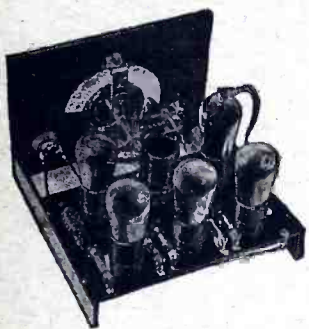
A New and Finer Receiver

# The Braxton-King Shield Grid Eight

**Tremendous R. F. Amplification—One Spot Reception—  
Super Selectivity—No Oscillation—Moderately Priced.**



## The Braxton-King Short Wave Five



A complete short wave receiver incorporating three stages of resistance coupled audio frequency amplification.

The Braxton-King Short Wave Five permits reception of broadcast and television signals between 15 and 120 meters, using four space wound plug-in coils to cover this band. A shield grid tube is used in the untuned antenna stage which serves to eliminate dead spots and prevent radiation. Regeneration is resistance controlled and the single dial can be logged on stations received.

The Foundation unit comes completely drilled with sockets, brackets, resistance mountings, blocking condensers, front panel and R.F. choke mounting already assembled assuring ease of construction.

Price. Set of 4 plug-in coils, antenna impedance and R.F. choke foundation unit ..... \$6.50  
..... 10.50

Perfectly matched intermediates and a radically new circuit design are responsible for the excellent results obtained with the Braxton-King Shield Grid Eight. The Plug-in Intermediates are TUNABLE permitting *exact* matching *after* the set has been wired and factors that would tend to throw ordinary transformers off peak are accurately compensated for. How important this is—and how greatly it increases the efficiency can only be appreciated after using these Braxton-King tunable Units. The circuit used is designed to give maximum amplification and still be non-critical in operation, and reception is one-spot throughout the entire broadcast range.

NOTE: We are prepared to convert any standard superheterodyne into a highly efficient Braxton-King Shield Grid Receiver, utilizing all of your present parts with the exception of the intermediate transformers and oscillator coil. These are replaced with our Braxton-King Intermediate Units, Plug-in Antenna and Oscillator coils and the set completely rewired and tested. Write for prices on this special work.

## The Braxton-King TUNABLE Intermediate Unit



These units are of the plug-in shielded type and have a peak frequency of 450 KC. giving one-spot reception throughout the broadcast range. Each unit is equipped with a small vernier condenser whose knob protrudes through the top of shielding case. This permits exact matching after they are installed in the set and guarantees an intermediate system that will work at top efficiency—at all times.

Price. Set of four .....\$25.00

Mississippi Valley Radio Co.,  
914 Pine Street  
St. Louis, Mo.

Please send me full information on:  
Braxton-King Shield Grid Eight—  
Braxton-King Short Wave Five—

I am interested in your plan of converting standard supers into a Braxton-King. Please quote price on this work for my set which is a.....

.....

Name .....

Address .....



## Official Wholesale Distributors Get Your Silver-Marshall Parts from W. C. Braun Company

We are the official wholesale distributors for all Silver-Marshall products—parts, kits, circuits, etc. A complete stock of S-M parts is on hand for immediate shipment to fill dealers' requirements anywhere.

### EVERYTHING IN RADIO

We carry the largest and most carefully selected line of radio goods in the country—the lines of the leading manufacturers of sets, parts, kits and accessories.

Mail orders given special attention. We are fully equipped to serve dealers on mail orders promptly and efficiently. Our new dealers' catalog lists over 4,000 items in radio, electrical goods, sporting goods, auto supplies and allied lines that keep the dealers' business humming twelve months of the year.

Write for free copy of this catalog on your letterhead and learn about our successful dealer plan.

## W. C. Braun Company Pioneers in Radio

594-B W. Randolph St.

**CHICAGO**  
ILLINOIS



# ARCTURUS HAS IT! A LONG LIFE POWER AMPLIFIER



Arcturus  
071H  
A-C Power  
Amplifier  
Heater Type

—that provides undistorted volume, better tone quality, humless reception,—and its life is unimpaired by line surge! Arcturus 071H is the first and only A-C Power Amplifier that has proven itself satisfactory in every way—because it is the *only* Heater Type A-C Power Amplifier on the market. Put an Arcturus 071H in your last audio stage—to end frequent replacement—to improve reception...There is an Arcturus A-C Long Life Tube for every socket.

ARCTURUS RADIO CO.  
220 Elizabeth Ave., Newark, N. J.

# ARCTURUS A-C LONG LIFE TUBES

## SET Builders FREE

A-C tubes have brought back custom Set building. Business is booming. Thousands of old-timers are cleaning up. Let Barawik show you the way to bigger profits, more sales. Send today for Barawik's Big Bargain Book—the radio man's bible.

**BARAWIK CO.** 412-R Canal St., CHICAGO, U. S. A.



Mail This Coupon Now for Free Radio Guide

Name .....

Address .....

## SET BUILDERS

write for  
**Discount Card**

Enabling you to purchase the new and Improved Knapp "A" Power Kit at big discount—Write for full particulars.

**DAVID W. KNAPP, Pres.**

**Knapp Electric, Inc.**

Division of P. R. Mallory & Co. Inc.  
Room 415, 350 Madison Ave., N. Y. C.

## ACME PARVOLT CONDENSERS

By-pass and Filter Condensers in all required MFD capacities and working voltages. Filter Condensers supplied in individual units or in completely wired and housed blocks for the more important power amplifiers. Made by The ACME WIRE CO., New Haven, Conn. Manufacturers of Acme Celatsite Wire—high insulation value, non-inflammable.

The receiver is extremely compact, using a front panel measuring only 7x9½, and a sub-panel 6x9½. Fixed resistances are used in place of rheostats for controlling the filament current of the tubes, and the only controls on the panel are the filament switch, tuning condenser dial and regeneration control.

The resistance coupled audio frequency amplification gives very good volume with 135 volts of B battery, and it has the additional advantage of being a type of audio amplification that is suitable for experimental television work. This will undoubtedly appeal to a great many experimenters who are working in this new radio field.

The construction of the receiver is comparatively simple and the cost of parts is low. If the foundation unit is used, the assembly is particularly easy. The foundation unit consists of front panel, support brackets, and a sub-base assembly which has mounted on it the five tube sockets and the socket for the plug-in coils, the fixed filament resistances, support clips for R.F. choke, all grid leak mounting clips, and three .006 mfd. fixed condensers. The base is also drilled for all other parts to be mounted, and the set is wired from the picture wiring diagram, packed with each foundation unit.

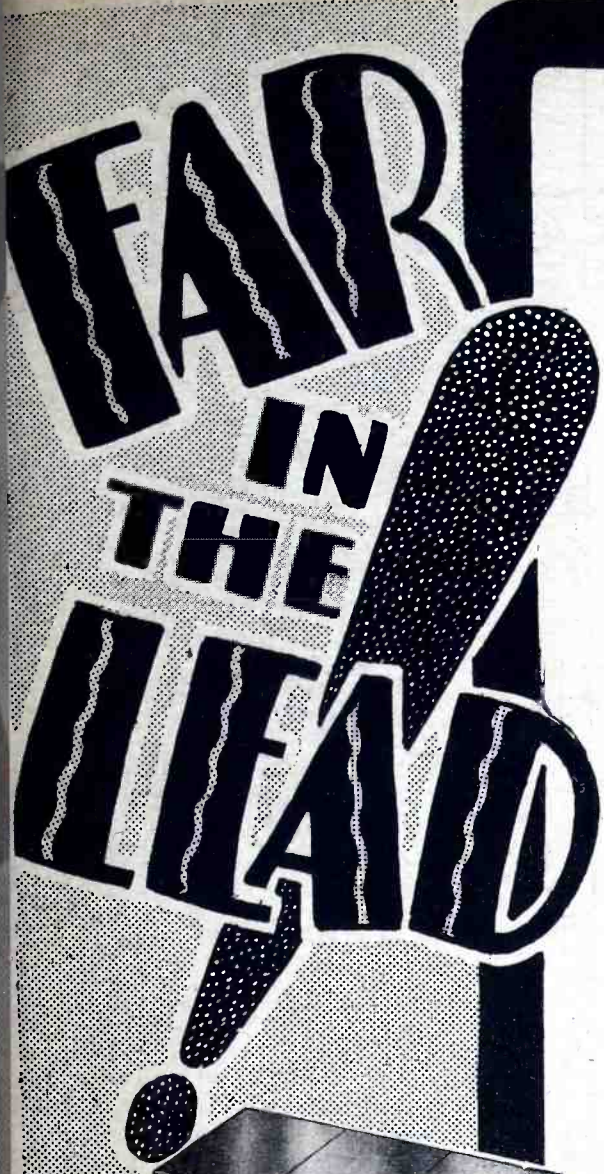
A good antenna and ground should be used. Antenna length may be between 40 and 100 feet in length. The antenna is connected to the binding post on sub-base and the ground direct to the negative A battery connection.

135 volts of storage or dry B battery should be used as an eliminator is not suitable for best results with a short wave receiver.

In operating the receiver, the only variable controls are the 500,000 ohm regeneration control and the tuning condenser. The adjustment of the regeneration control is of extreme importance. As this is slowly turned to the left a point will be reached where the detector tube starts to oscillate. This point can be determined by touching the stator plates of the condenser with a moistened finger. As the set goes into oscillation, a pronounced "plunk" will be heard in the head-phones. The detector tube will continue to oscillate with any additional turning to the left of regeneration control. However, the carrier wave signal will be most pronounced if the regeneration control is turned just to the point where oscillation starts, and no farther. The variable condenser is then slowly rotated until the carrier wave of a station is picked up. A slight readjustment of both controls should then bring in the station.

The tuning of a short wave receiver is much more critical than that of a standard broadcast receiver and unless care is used the beginner is liable to pass right by a station. It is best to use head-phones in tuning the set and then after the signal is adjusted to maximum volume, switch over to the loud speaker.

If uttermost care has been taken in the construction of this set, the builder will be more than repaid for his efforts in the thrill of receiving distant stations broadcasting on short wave lengths.



# Halldorson Shield-Grid 56 Kit

*Six Tube, Push-Pull—Shield-Grid First Audio*

## Shield-Grid Receiver Perfected

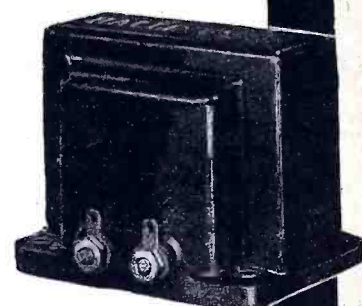
The tremendous advantages of shield-grid tubes are used to the very limit in both R.F. and audio stages in this new Halldorson kit. Unlimited distance is possible because of the extreme selectivity and sensitivity.

## Halldorson Set the Last Word in Shield-Grid Kit Design

The Halldorson Shield-Grid 56 receiver is the last word in kit design and embodies more new features than any other kit of its kind available to set builders. Its bronze front escutcheon plate carries all controls and may be mounted on the steel front panel supplied or the wood panel found in most console cabinets. All parts are mounted upon a steel crystalline finished sub-base and the sockets are riveted in place at the factory.

The Halldorson Shield-Grid 56 receiver is the last word in kit control. Distant stations boom in one after another as the big knob is turned. The audio system, the last stage of which consists of two 171 tubes in a push-pull circuit, develops tremendous power and gives a quality that is above criticism.

Handsome copper shields suppress entirely all outside interference and produces razor-edge selectivity.



**Halldorson Push-Pull Transformers**  
The secret of the deep rich overtone amplification heard only in Halldorson transformers, is the exclusive use of expensive one piece die cut laminations.



**Halldorson 180 Power Unit**  
Halldorson A. B. C. power units for A.C. tubes are quiet in operation. Easy stabilization of R.F. stages. Self contained bias resistors and center tap resistors. Sold wired.

## Phonograph Pick-up Switch

An added feature is the phonograph pick-up switch, by means of which an electric pick-up may be attached to the receiver and phonograph or radio music had at will.

## Shield-Grid First Audio Stage

The first stage of audio amplification is also a shield-grid tube. This type of tube was selected for this stage after many laboratory tests, because of its superior ability to amplify very weak detector signals, while at the same time handling the large power demands made upon it, with ease and smoothness. This is one of the important improvements in the Halldorson 56 receiver, because it permits loud speaker operation of signals that are ordinarily too weak to satisfactorily swing the grids of the amplifier tubes.

## Amazingly Low Price

Only the huge production facilities of the Halldorson plant make these prices possible. Compare the Halldorson 56 with any other kit on the market. Never before has such value been offered.

Halldorson Shield-Grid 56 Kit ..... **\$59.85**

THE A.C. 56 is a receiver of similar design but for A.C. operation. Uses shield 226 in the r.f. and first audio stages. Complete details on this and other Halldorson kits and parts sent upon request. Shield Grid A.C. model will not be available until shield grid A.C. tubes are out of the experimental stage.

## PLAIN FACTS

**Selectivity**—Guaranteed 5 to 8 K.C. separation of locals.

**Sensitivity**—On a 40-ft. antenna it will bring in distant stations with greater volume than most 9 or 10 tube receivers.

**Volume**—Shield-Grid first and Push-Pull second audio deliver tremendous power on weak input signals. Total gain over 6,400,000 times, several times that of any receiver not using a space charge Shield-Grid first audio tube.

**Price**—Compare the price with that of any other kit on the market. Never before has such value been offered.

**Appearance**—The keenest job you've ever seen.

Local Chicago service stations: H. R. Morrison, 2856 N. Clark St., Chicago, Ill.; North Shore Radio Laboratories, 6902 N. Clark St., Chicago, Ill.

# Halldorson Radio Products

THE HALLDORSON COMPANY Dept. 3  
4745 N. Western Ave., Chicago

I would like my name placed on your mailing list to receive all future literature.

I am interested in Halldorson Products. Please send catalog.

NAME .....

ADDRESS .....

JOBBER'S NAME IF ANY .....



Radio dealers recommend and use the

# ekko Ground Clamp

because it eliminates the high percentage of radio troubles due to faulty ground

Imperfect ground contacts are responsible for a high percentage of all radio troubles. The ekko Clamp eliminates these troubles by insuring perfect contact. Radio dealers know this. That is why they include an ekko Clamp with radio set installations and instruct their service crews to use it in replacing old faulty grounds.

The hardened steel points of the ekko Clamp bite through paint, rust, dirt, corrosion or any other insulation. Its positive contact insures full signal strength. Easy to use. Ground wire screws to Clamp. Clamp attaches to nearest pipe by a turn of the screw. Noncorrosive, permanent. Finished in white nickel. Fits 1/4 to 1 1/4 inch pipe. At your dealer's.

**Radio dealers:** The ekko Clamp is supplied in lots of ten in an attractive counter display that helps you sell this most popular of all ground clamps.

25¢



## The Ekko Company

111 West Monroe Street, Chicago, Ill.

# A New Hotel Without "UPS"!

IT'S NEVER BEEN DONE BEFORE!

One Price for All the Rooms!



COME AND COMPARE!

## Cornish Arms Hotel

WEST 23d STREET, at Eighth Avenue  
NEW YORK

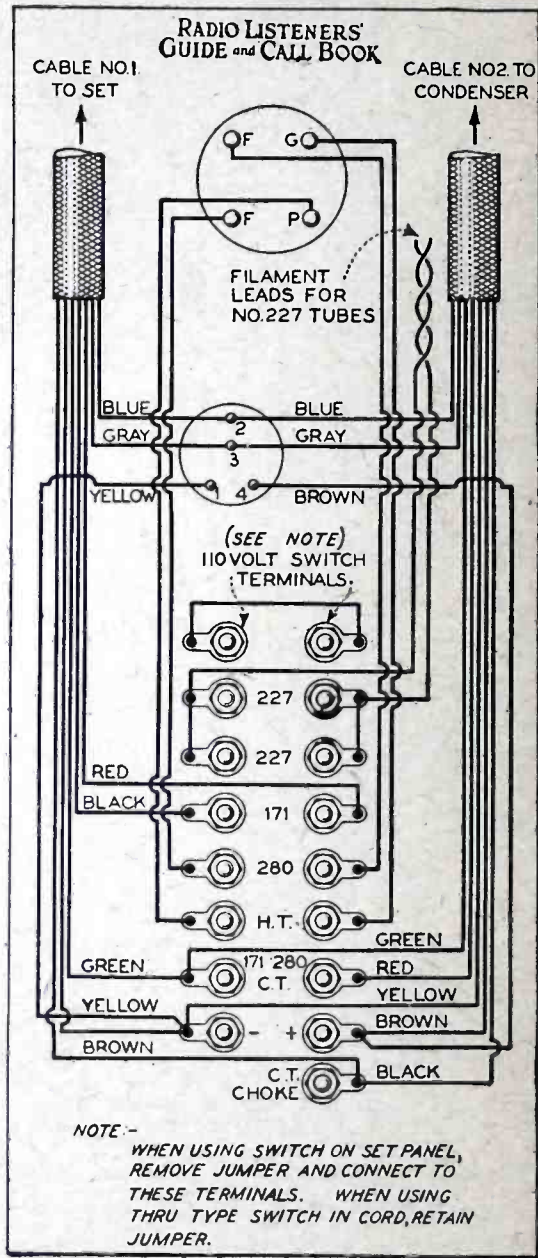
THE twelve-story fireproof Cornish Arms Hotel, just opened, has eliminated all the hokum of "up" prices. This convenient and comfortable new hotel has only one price for a single room and bath, \$3.00 per day. Double room for two, with bath, \$4.50. Remember, there are no "ups." There's a bath with every room; 340 rooms to select from. Excellent restaurant service at moderate prices.

Five minutes to Times Square, five minutes to Penn. Station, eight minutes to Grand Central, and near all Steamship Lines.

## The Aero Metropolitan A. C. Four

(Continued from page 65)

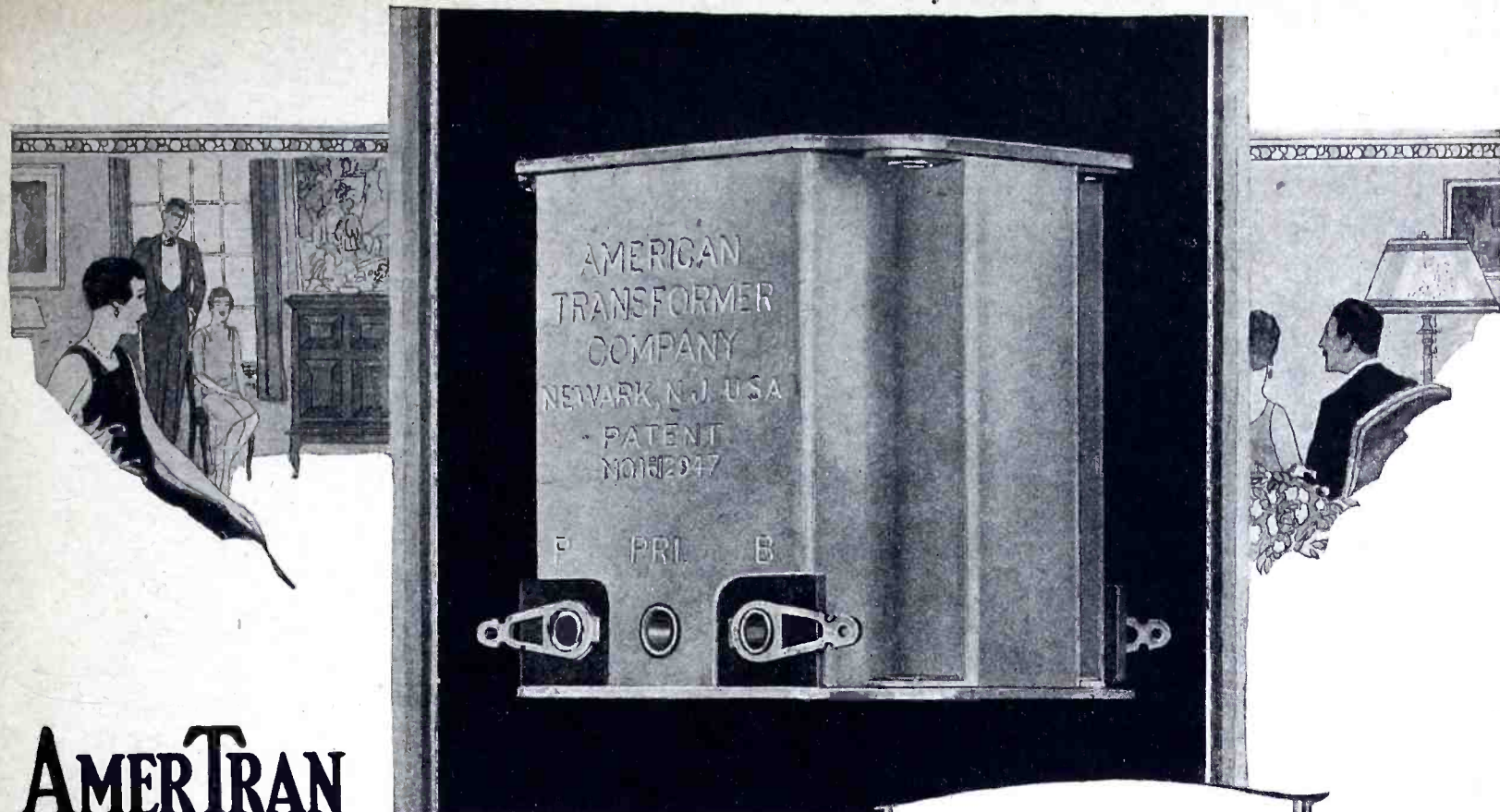
per stage can be obtained without the introduction of distortion by the means of the Hi-Mu tube. In other words, the impedance of this transformer to even the lowest tones is so high that a perceptible increase in amplification is obtained even on these very low frequencies when the high impedance valve is utilized. No connections need be changed to put this tube in and it can be inserted in the regular socket, exactly in the same way as the 201-A which it replaces.



Connections to terminal board of the power unit.

Very few notes on the assembly of the set are necessary. The filament leads to the heaters of the 227 tubes in the A.C. model should be twisted and brought to the two binding posts for which holes are provided on the subpanel. The leads from these binding posts to the secondary of the filament transformer can be advantageously maintained as short as possible and if the Aero filament transformer is employed, it is suggested that it be inserted in the cabinet for the insertion of a B supply unit, thus getting the receiver and all its accessories, with the exception of the loud speaker, into the cabinet.

In building up the set, it can either be constructed in the ordinary breadboard



**AMERTRAN**  
TRADE MARK REG. U.S. PAT. OFF.

## Quality Radio Products

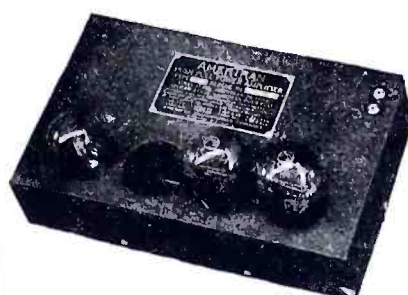
Standards of Excellence for Radio Reproduction

THE real worth of any radio set depends upon "tone quality"—the ability to reproduce music as it is broadcast from the studio. The problem has never been one of refining the radio frequency amplifier—it has always been the manufacturers of audio systems who have had to develop their products to reach the pinnacle of natural reproduction.

Long before broadcasting was thought of, The American Transformer Company had gained a reputation of manufacturing quality products. Since the era of broadcasting, this company has occupied a unique position in the development of quality products for Radio Reproduction. AmerTran products have been considered too expensive for set manufacturers to use in their commercial receivers, so it has developed a clientele of set builders who want, first of all, *natural reproduction*.

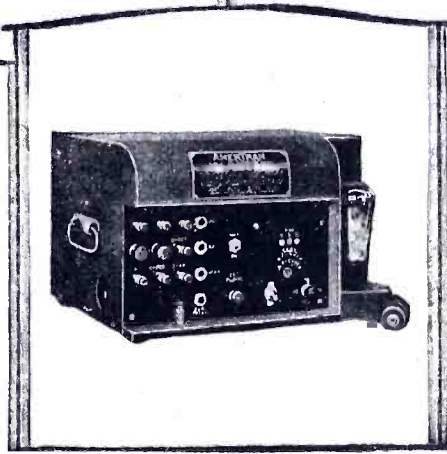
AmerTran products are never built down to a price—the procedure has always been reversed—"How good can it be made—then reduce the cost by applying economies in manufacture."

The products shown on this page are but a few of the thirty odd AmerTran devices in the field of radio reproduction, each of which has attained the degree of perfection necessary to be introduced as an AmerTran product. The facilities of our engineering department are at the service of every one interested in better radio reproduction. We will answer to the best of our ability any question in the audio or power fields.



AmerTran Push-Pull Amplifier—complete 2 stage audio amplifier. First stage AmerTran DeLux and second stage AmerTran Push-Pull for two Power Tubes. Choice of standard amplifier or UX 227 AC for 1st stage and two 171 or two 210 power tubes for second stage. Price, east of Rockies—less tubes—\$60.00.

AmerTran ABC Hi-Power Box—500 volts DC plate voltage, current up to 110 ma; AC filament current for rectifier, power tubes and sufficient 226 and 227 AC Tubes for any set. Adjustable bias voltages for all tubes. Price, east of Rockies—less tubes—\$95.00.



AmerTran Push-Pull Power Stage (illustrated below)—completely wired with input transformer and a choice of 4 output transformers depending on speaker and power tubes. Adaptable to 171 or 210 tubes, cones or dynamic type speakers. Price, east of Rockies—less tubes—\$36.00.



Push-Pull Amplifier, ABC Hi-Power Box and Push-Pull Power Stage licensed under patents owned or controlled by RCA and may be bought complete with tubes.



**AMERICAN TRANSFORMER COMPANY**  
Transformer Builders for more than 28 years  
90 EMMET ST. NEWARK, N.J.



Send Your Orders to  
**WHOLESALE RADIO**  
**HEADQUARTERS**

for

# AERO KITS

The Aero 4-tube Metropolitan Receiver and all of the famous Aero Short-Wave and Broadcast Receiver and Transmitter Kits, parts and supplies are carried in stock at Wholesale Radio Headquarters, W. C. Braun Co., Chicago, Ill., who are official distributors for the complete Aero line.

Dealers and setbuilders are urged to send their orders here, where they will be carefully and promptly filled and shipped.

Nowhere in the country will you find such a huge assortment of everything needed by the radio set builder and dealer—including complete kits of all circuits, parts, supplies, accessories and complete factory-built sets, both A.C. and D.C.

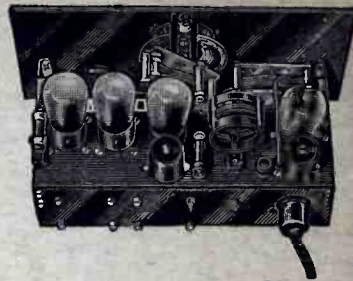
If you have not received the big 264-page Braun's Big Radio Buyers' Guide, be sure to send for it today. Write on your letter head and free copy will be mailed you at once.



**W. C. BRAUN COMPANY**  
*Pioneers in Radio*

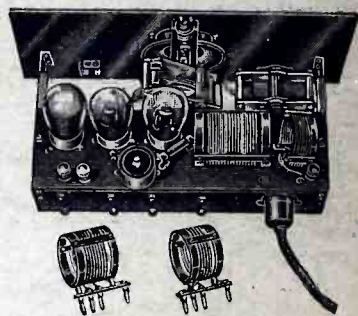
592 W. Randolph St.

**CHICAGO**  
 ILLINOIS



**INTERNATIONAL**  
 Short Wave Receiver

This is the first short wave receiver designed exclusively for the reception of broadcast on low waves. Broadcast reception on short waves is remarkably clear and free from static. Programs come in from greater distances with the utmost simplicity of control. Complete kit includes everything necessary to assemble the set.  
 Aero Kit No. 8—Price.....\$55.30



**STANDARD**  
 Short Wave Receiver

This three-tube short wave receiver utilizes a circuit which has been proven by years of excellent results in the hands of amateur operators. The audio transformers are of the same type as are used in broadcasting stations, assuring excellent tone quality even when receiving programs from a great distance.

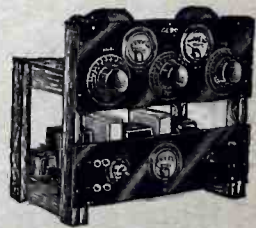
Aero Kit No. 10 for A.C. Tubes.  
 Price .....\$49.95  
 Aero Kit No. 11 for D.C. Tubes.  
 Price .....\$49.95



**STANDARD**  
 Short Wave Converter

You can receive short wave programs on your present set by utilizing this short wave converter. Kit is complete. The base panel has all parts entirely assembled on it, wired and tested. It is only necessary to connect four or five wires to use this converter.

Aero Kit No. 12 for D.C. Tubes.  
 Price .....\$32.00  
 Aero Kit No. 14 for A.C. Tubes  
 Price .....\$32.00



**Short Wave Transmitter**

For either the man who wishes to build his first low-power transmitter or for the dyed-in-the-wool amateur who wants to purchase all the parts for a high-powered installation from one source. Aero Transmitters are available in complete, easy-to-assemble kits. Prices on application.



# AERO KITS INTERNATIONAL



## Short Wave Receivers and Converters

Aero Short Wave Coils have always been known as the best which can be obtained . . . they have never disappointed a user . . . we believe there are more Aero Short Wave Coils in use than any other variety . . . there must be a reason.

The Aero "International" Receiver and the Aero Short Wave Converters have been designed to secure the maximum results from Aero Coils . . . they have been in the hands of the public sufficiently long to demonstrate their worth . . . and in buying Aero Short Wave Kits, you are getting the best the market affords . . . at no greater cost.

### INTERNATIONAL SHORT WAVE RECEIVERS

The Aero "International" Short Wave Receiver is the first receiver designed particularly for short wave broadcast reception. It has only one tuning control and one volume control. One stage of shield grid R.F. amplification gives unbelievably smooth control and makes the receiver non-radiating. Extremely simple to construct, for blueprints show the position of every wire and instrument. Sure to give excellent results. The finest short wave receiver obtainable at any price. Complete kit contains everything necessary to put the set together without spending another cent.  
Kit No. 8. Price.....\$55.30

### SHORT WAVE CONVERTERS

The Aero "Standard" Short Wave Converter for A.C. or D.C. receivers can be assembled in a few minutes. All the parts are mounted on the foundation unit which is completely wired and tested. It is only necessary to connect four or five wires to make this converter ready for use. It can be plugged into the detector or sometimes the first R.F. socket of any receiver, utilizing the same tube which has been removed from the socket in which the converter is plugged. This is the simplest converter to build and is adapted to any receiver, regardless of type.  
Kit No. 12 for D.C. Tubes. Price \$32.00  
Kit No. 14 for A.C. Tubes. Price 32.00

### TEAR OFF AND MAIL BACK

Aero Products, Inc., Dept. 898.  
4611 East Ravenswood Ave.,  
Chicago, Ill.

Gentlemen:

Enclosed find my quarter for a copy of the New 1929 Aero Green Book which contains an article on efficiency of coils, complete data for constructing three short wave receivers and three short wave converters, as well as twenty-eight broadcast receivers, and entitles me to Supplements which will contain complete construction data on future types of receiver as they are announced and on the new and efficient "1929 Style" Aero Radiophone and Code Transmitters.

Name .....

Street .....

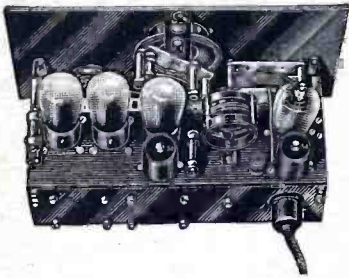
City .....State.....

# AERO PRODUCTS INCORPORATED

4611 EAST RAVENSWOOD AVE., CHICAGO, ILL.

# AERO KITS

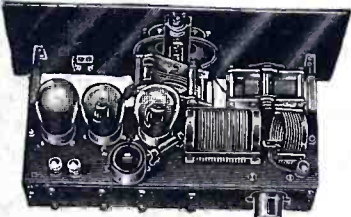
## "METROPOLITAN"



### INTERNATIONAL Short Wave Receiver

This is the first receiver designed exclusively for short wave broadcast reception. Broadcast programs on short waves are remarkably clear and free from static. You can receive them on the Aero International. There is only one tuning control and the set is extremely easy to operate. The complete kit includes everything necessary to put the set together without spending another cent. Full size pictorial wiring diagram make assembly easy.

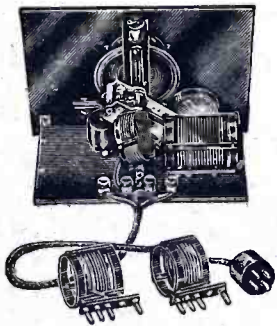
Price ..... \$55.30



### STANDARD Short Wave Receiver

The Aero Standard Three-Tube Short Wave Receiver for either A.C. or D.C. tubes utilizes a regenerative circuit which has been proven by years of excellent results in the hands of amateur operators. The same special audio amplifier is supplied as is used in the Aero "Chronophone" and other high grade broadcast receivers, so that excellent quality can be assured when receiving far-distant stations. Kit is complete with nothing else to purchase.

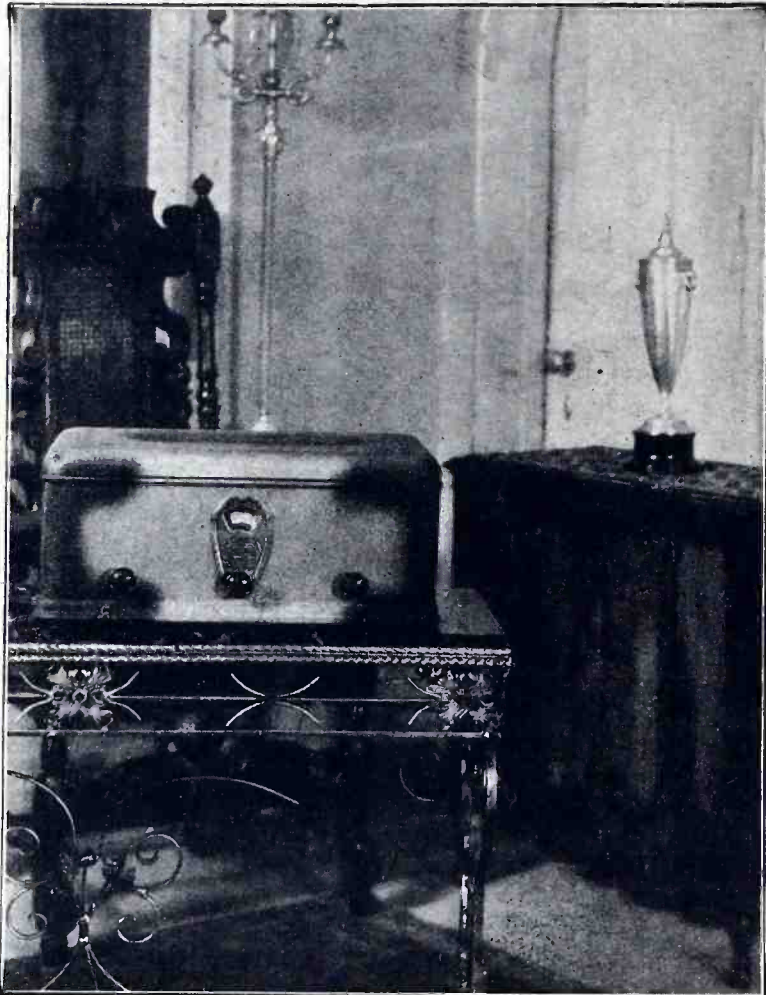
Price ..... \$49.95



### STANDARD Short Wave Converter

You can receive short-wave programs on your present broadcast receiver by merely plugging the Aero International Short Wave Converter into the detector socket. It will add thousands of miles to the range of your receiver. Kit is complete and pictorial diagrams make wiring easy.

Price ..... \$32.00



THE Aero "Metropolitan" Receiver is the lineal descendant and the latest and most improved form of an illustrious line of receivers. The "Roberts" Receiver, first presented by Dr. Walter Van Bramm Roberts several years ago proved to be easily the most outstanding receiver of its kind and his circuit remains basically unchanged to the present time, although improvements in instruments and coil design have made the later models superior to his original type.

The Aero "Metropolitan" comes in complete kit form, even the cabinet, solder and machine screws being included. You have nothing else to purchase, and no other tools are required other than a screw driver and soldering iron to assemble this set. Beautifully complete blueprints, with every wire clearly delineated, and the position of every instrument shown exactly, make assembly extremely simple. The use of the new Aero Audio Transformers assure the user of a quality superior to any other receiver of anywhere near the same cost. In the A.C. model particularly, if the power supply is available, a 210 or 250 power tube can be used with no changes whatever in the wiring. The new Aero Type U-63 and U-73 Coil Kits for shield grid and standard tubes respectively, give even greater sensitivity and selectivity than past models. A new system of regeneration control surpasses all previous units in smoothness and ease of operation.

In purchasing a kit for the Aero "Metropolitan" Receiver, you are assuring yourself of good results and a receiver of which you will be proud, both in appearance and performance.

Price, Complete Kit ..... \$74.50  
(Specify whether for Shield Grid, A.C. or D.C. tubes.)



### Universal Broadcast Receiving Coils

Aero Universal Coils, for broadcast reception, will make any circuit better in selectivity, tone and range. All coils are twice matched at both ends of the broadcast band and thus absolute uniformity is assured. May be purchased singly or in kits for use in every type of circuit.



### Interchangeable Short Wave Receiving Coils

Aero Interchangeable Coils have won a world-wide reputation because of their superior low-loss construction, general sturdiness and excellent electrical characteristics. These coils are of the plug-in type and are furnished as complete tuning kits. Wavelengths from 16.5 to 89.5 meters are covered by these kits.



### Audio Transformers

Aero Audio Frequency Transformers utilize a type of construction heretofore limited to transformers used in the line amplifiers of broadcasting stations and now made available to the public for the first time. They will positively give better results than any other audio transformer on the market. Type A. E. 770.

Price ..... \$6.00

**We Stock Every Item in the AERO line of Kits, Coils and Parts.**

## Western Radio Mfg. Co.

"The Big Friendly Radio House"

128 West Lake St., Dept. RG-2, Chicago, Ill.



WESTERN RADIO MFG. CO.  
128 W. Lake St., Dept. RG-2  
Chicago, Ill.

Please send at once your new FREE catalogue listing parts and kits as well as many other highest-quality radio products.

Name

Address

City

State

# AERO KITS

## IN STOCK For Prompt Shipment

The famous Aero line of parts and kits is in stock here, ready for your call. Along with it are the products of the country's foremost manufacturers of parts, kits, accessories and receivers, all combining to place at your disposal one of the most tremendous stocks of radio ever gathered together under one roof.

### Wholesale Prices

In our large general catalog, we quote net wholesale prices, placing before the set builders of the country, lowest dealer's prices, enabling you to realize a handsome profit on every purchase you make from Allied.

### Everything In Radio

In the large Allied catalog will be found listed new A.C. and D.C. sets, priced as low as \$32.95. Also a wonderful array of consoles and accessories along with practically all of the nationally advertised lines in parts and kits at prices that actually defy competition.

### A New Radio Service

The Allied organization is trained to service. Real team work—a competent personnel and our tremendous stocks of merchandise—all combine to make possible the Allied reputation for promptness in shipping.

### FREE CATALOG

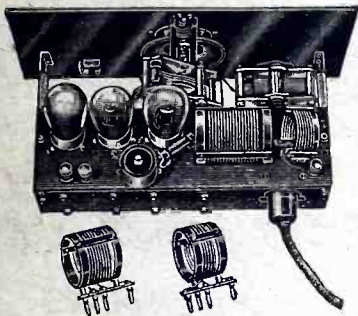
The large Allied catalog is free for the asking. We want every dealer, set builder and radio enthusiast to have a copy. Check Allied prices—service—quality—and you will agree with us that dollar for dollar you get greater values—and better merchandise in your purchases from Allied. Write for catalogue now!

**ALLIED RADIO CORPORATION**  
711 W. LAKE ST., CHICAGO



#### Standard Short Wave Converter

Will adapt any A.C. or battery receiver for short wave reception. The simplest converter to build and the easiest to assemble.



#### Short Wave Receiver

3-tube short wave receiver for either A.C. or D.C. tubes. Utilizes a regenerative circuit which has been the amateur standard for years. Highly efficient, non-critical.



#### Short Wave and Matched R.F. Coils

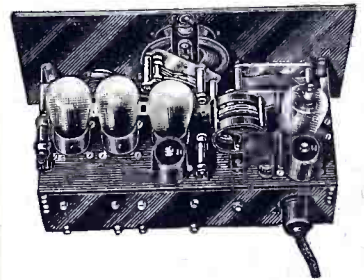
The new Aero international short wave interchangeable coils reach a high degree of efficiency.

Matched TRF coils also for A.C., battery and shield grid receivers. Coils for every purpose including three circuit tuners, antenna couplers and wave trap units.



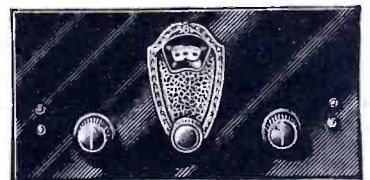
#### International Converter

A new short wave adapter utilizing a shield grid tube and regenerative detector. Only one tuning control. Quickly and easily converts any battery receiver for short wave reception.



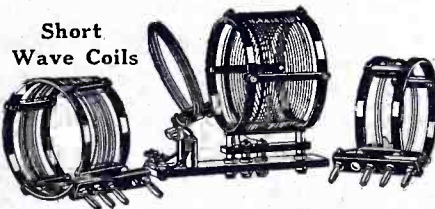
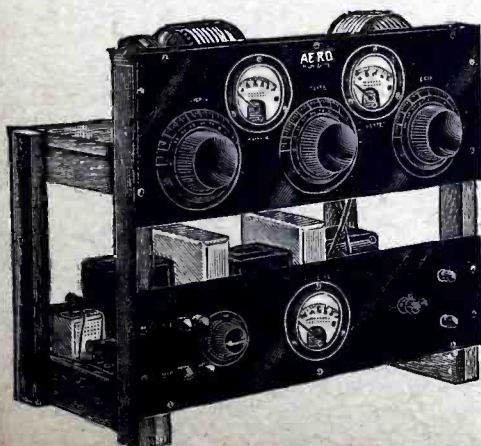
#### International Short Wave

The finest short wave receiver obtainable at any price. Incorporates one stage of shield grid amplification. Non-radiating. Utilizes four tubes for utmost efficiency. Single dial operation.



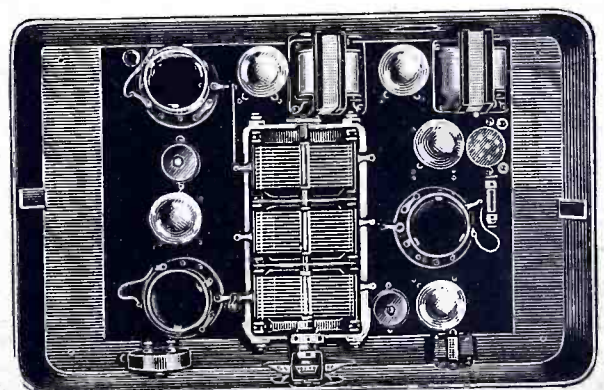
#### Chronophase Shield Grid

Carefully engineered 5-tube receiver utilizing the new Chronophase circuit for either shield grid, A.C. or D.C. tubes. Highly selective. Single control operation. Extremely fine tone quality.



#### Aero Transmitters

Low power short wave transmitters for the amateur who wishes to obtain the utmost in efficiency with the least expenditure. Complete phone or code transmitters.





## "Metropolitan"

The Aero "Metropolitan" is a four-tube receiver especially designed to secure the maximum possible gain from the already popular radio frequency regenerative circuit. Special coil kits allow the use of shield grid tubes or of 01-A tubes with the inter-electrode capacity of the tube neutralized as in the popular Roberts and Chicago Daily News circuits. A novel and extremely efficient method of controlled regeneration is employed which also operates to stabilize the R.F. amplifier, automatically compensating for any slight changes introduced by careless wiring, and at the same time gives greater selectivity as the sensitivity of the receiver is increased. The audio amplifier is the same broadcasting station type employed in the more expensive Aero Kits and will assure the user of the finest tone quality. The receiver is built in the small cabinet illustrated. This receiver is, we believe, the most sensitive four-tube receiver available to the builder and surpasses most six-tube receivers.

Aero Complete Kit No. 26 for Shield Grid Tubes. Price .....	\$58.00
Aero Complete Kit No. 27 for A.C. Tubes. Price .....	\$58.00
Aero Complete Kit No. 28 for D.C. Tubes. Price .....	\$58.00
Aero Complete Kit No. 26-P for Shield Grid Tubes. Price .....	\$53.00
Aero Complete Kit No. 27-P for A.C. Tubes. Price .....	\$53.00
Aero Complete Kit No. 28-P for D.C. Tubes. Price .....	\$53.00

## Aero-Dyne



The Aero-Dyne is a six-tube receiver of supreme excellence. Three stages of "Chronophase" radio frequency amplification will utilize any type of tube, whether it be shield grid, A.C. or D.C. to the maximum advantage. Uses the new special broadcasting line audio amplifier and is the most sensitive and selective receiver which can be built for anything like the money. Trans-continental reception can be properly expected from the Aero-Dyne under favorable conditions. This kit includes the large cabinet illustrated. A.C. set uses five 227 tubes with 171 power amplifier. D.C. set uses either shield grid or 201-A tubes and 171 power amplifier.

Aero Complete Kit No. 23 for Shield Grid Tubes. Price .....	\$93.50
Aero Complete Kit No. 24 for A.C. Tubes. Price .....	\$93.50
Aero Complete Kit No. 25 for D.C. Tubes. Price .....	\$93.50

NOTE: For those wishing to build the set in a console or table, the same kit is supplied except that a handsome walnut finish Westinghouse-Micarta 7x18" drilled and engraved panel is supplied in place of the cabinet.

Aero Complete Kit No. 23-P for Shield Grid Tubes. Price .....	\$83.50
Aero Complete Kit No. 24-P for A.C. Tubes. Price .....	\$83.50
Aero Complete Kit No. 25-P for D.C. Tubes. Price .....	\$83.50

# WHOLESALE DISTRIBUTORS for

# AERO KITS

The Aero 4-tube Metropolitan, the sensation of the season in Custom-Built Radio, is selling its head off. Dealers and set-builders the country over realize that this economical, all-purpose radio circuit, is the final word in quality radio reception. Wholesale Radio Service Co endorses this circuit of circuits and offers to its customers, dealers and set-builders, an unusual service in filling complete orders with same-day delivery assured.

The various Aero broadcast and short-wave receivers, transmitters and parts are kept in stock by us. Send us your orders for these fast selling items as well as any of the standard radio circuits, parts and supplies on the market. We carry everything you need. Send the coupon now for complete illustrated catalog and wholesale price list.

## Wholesale Radio Service Co.

*A Service of Excellence to the Dealer*

6 Church St., Dept. AR-1—N. Y. City

### Mail This Coupon Now

Wholesale Radio Service Co.,  
6 Church Street, Dept. AR-1,  
New York, N. Y.

Please send your new FREE catalog, listing a full line of Aero kits and parts, as well as all other standard brands of radio products for the dealer and setbuilder.

Name .....

Address .....

Town ..... State .....



## Aero-Seven TWENTY-NINE

The Aero Seven-Twenty-Nine is a seven-tube DeLuxe model employing three stages of "Chronophase" radio frequency amplification and one semi-aperiodic stage. Extreme selectivity and great sensitivity assures the user of distance and "pep," while the improved audio amplifier gives truly surprising tone quality. A 71 power tube is employed in all models. In the A.C. model six 27 tubes are utilized and in the D.C. type six 01-A type tubes. The shield grid model uses four shield grid tubes two 01-A's and one 171. The semi-tuned antenna stage reduces static pickup considerably. This receiver uses the large size cabinet and is the most satisfactory set in every way which can be purchased.

Aero Complete Kit No. 32 for Shield Grid Tubes. Price .....	\$97.85
Aero Complete Kit No. 33 for A.C. Tubes. Price .....	\$97.85
Aero Complete Kit No. 34 for D.C. Tubes. Price .....	\$97.85

NOTE: For those wishing to build the set in a console or table, the same kit is supplied except that a handsome walnut finish Westinghouse-Micarta 7x18" drilled and engraved panel is supplied in place of the cabinet.

Aero Complete Kit No. 32-P for Shield Grid Tubes. Price .....	\$87.85
Aero Complete Kit No. 33-P for A.C. Tubes. Price .....	\$87.85
Aero Complete Kit No. 34-P for D.C. Tubes. Price .....	\$87.85



## Chronophase

The Aero "Chronophase" Receiver is a five-tube set embodying two stages of tuned radio frequency utilizing the "Chronophase" circuit for either shield grid, A.C. or D.C. tubes, and the new Aero broadcasting type audio amplifier. Uses a 171 power tube. This receiver is recommended as the best low priced all-purpose receiver on the market. Selectivity is sufficient to separate powerful locals without difficulty and reception reports of two thousand miles are not unusual. It is designed for use in the smaller of the two cabinets illustrated, making a handsome addition to the most well-appointed living room. A.C. Receiver uses four 227 tubes. Very simple to connect.

Aero Complete Kit No. 20 for Shield Grid Tubes. Price .....	\$74.50
Aero Complete Kit No. 21 for A.C. Tubes. Price .....	\$74.50
Aero Complete Kit No. 22 for D.C. Tubes. Price .....	\$74.50

NOTE: For those wishing to build the set in a console or table, the same kit is supplied except that a handsome walnut finished Westinghouse-Micarta 7x18" drilled and engraved panel is supplied in place of the cabinet.

Aero Complete Kit No. 20-P for Shield Grid Tubes. Price .....	\$68.55
Aero Complete Kit No. 21-P for A.C. Tubes. Price .....	\$68.55
Aero Complete Kit No. 22-P for D.C. Tubes. Price .....	\$68.55

style with a front panel, or the foundation unit can be purchased containing a completely drilled subpanel fitted to a handsome two-toned metal cabinet. The construction details of the breadboard layout have been described so many times that it would be superfluous to go into such construction here, but as the manufactured type receiver is somewhat new to kit builders we will describe this style a trifle more fully.

First mount the condenser on the base panel, using the small bakelite bushings provided to lift it off the base panel. Mount the coils, carefully observing the position of the numbered terminals to get them arranged as they are on the diagram. When mounting them put long lugs under each of the mounting screws, placing them exactly as shown in the drawing, so that they will take care of the connections which pass through the panel from the coil. When mounting the audio transformers put the machine screws through the outside holes, leaving the inside holes for connections. Attach the Yaxley cable connector plate by means of one machine screw and the Eby binding post. Now wire the set following out the schematic circuit diagram or the pictorial wiring diagram. It will be noted that the R.F. and detector each operate with the section of the condenser alongside them and that the grid connections are kept very short by the use of the condenser stator plates, which are, of course, at grid potential anyway, as a portion of the grid leads. Connect the Amsco Midget and the Aero Centralab resistor by means of flexible wires, as well as the dial lamp.

The set is now in condition to be tried out. Hook the cable up to the batteries or eliminator, following the regular color code indicated on the diagram and put some kind of a knob on the condenser shaft to facilitate tuning it. Turn the volume control knob all the way to the side opposite the switch. In rotating the dial, numerous squeals should be heard as stations are passed. Find the low point of one of the squeals and then retard the volume control, until the circuits go out of oscillation. After doing this, a re-adjustment of the midget condenser should bring the signal in with somewhat more volume, after which if it is a distant station, further adjustment of the volume control and main dial may seem desirable. The midget condensers should work in most cases with the midget half in mesh and the volume control in approximately the same position as in pictorial wiring diagram. After all adjustments have been made, and it is determined that the set is operating properly, mount the dial on the cabinet. Loosen the set screw which will take the condenser shaft. Mount the 17/8 in. bushings in the proper holes on the bottom of the cabinet. Loosen the shaft of the variable condenser and slide it back. Then drop the set into the cabinet, sliding the condenser shaft forward into the dial and tightening all set screws. Attach the volume control and the midget condenser to the cabinet and tighten up all the bushings. Put the cable connector into the cabinet through the large hole in the back and the antenna through the small hole. The set is now ready to be put in the living room.

# OFFICIAL NATIONAL WHOLESALE DISTRIBUTORS

## AERO KITS

This year Aero has a most remarkable line of receivers for the man who wants to build his own set. Two of the best kits they have are the "METROPOLITAN" and the "CHRONOPHASE" shown below. They have the "kick," "pep," tone and distance so much to be desired by every radio set builder. Parts of highest type insure great sensitivity, complete volume and fine reception on both local and distant stations.

### "CHRONOPHASE" + "METROPOLITAN"

An outstanding 5-tube set with a great reputation. When wired it embodies two stages of tuned radio frequency, utilizing the famous "Chronophase" circuit for Shield Grid, A.C. or D.C. tubes. Best of all the new Aero audio frequency transformers are included. Employs a 171 power tube and the A.C. receiver uses four 227 tubes. Complete blueprints and diagrams are furnished, making it easy to put together. Supplied with a drilled and engraved walnut finished bakelite front panel 7 x 18 inches. Complete kit of parts lists at \$68.55 and our special price to you is \$40.31.

For shield grid tubes order No. 2 L-3685; for A.C. tubes order No. 2 L-3686; for D.C. tubes order No. 2 L-3687.

This well-known set when wired correctly will secure the maximum gain from the popular radio-frequency regenerative circuit. The coils supplied with this kit allow the use of either shield grid or 201A tubes, with the interelectrode capacity of the tube neutralized. The Aero audio transformers are of a type heretofore used only in broadcast station amplifiers. Supplied with drilled and engraved bakelite walnut finished front panel 7 x 18 inches. Complete blueprints and instructions with each kit. The list price is \$53 and our special price to you is \$31.16.

For shield grid tube kit order No. 2 L-3682; for A.C. tube kit order No. 2 L-3683; for D.C. tube kit order No. 2 L-3684.

Send for Our Big Wholesale Radio Catalog  
It's Free

It contains entire Aero line of kits, sets and parts as well as 100 pages of other popular radio kits, accessories, consoles, etc. Lowest prices. Quick service. Write for your FREE copy today.

## Setbuilders Supply Co.

155 Romberg Bldg.

Chicago, Ill.

### CLASSIFIED OPPORTUNITIES

Rate 12c a word

#### Help Wanted

\$100 PER MONTH in your home, folding and mailing circulars. We furnish everything. Particulars and samples 25c. Numa Co., 48 Adams St., Irvington, N. J.

#### Printing, Engraving, Multigraphing

FINEST Bond Letterheads, 8 1/2 x 11, \$3.95 M. Envelopes, \$2.95 M. Oberman Company, Box 1042, Chicago.

#### Radio

CHEMRAD Radio Chemical Outfit. Experimenters, you should know Radio Chemistry, the alluring, thrilling, new science. Complete outfit includes chemicals, metals, apparatus, instructions sufficient to carry on chemical and radio experiments, even television. Send \$4.98 money order, or sent C.O.D. Satisfaction guaranteed. Chemical Radio Co., 4730F Drexel Blvd., Chicago.

### FREE RADIO CATALOG

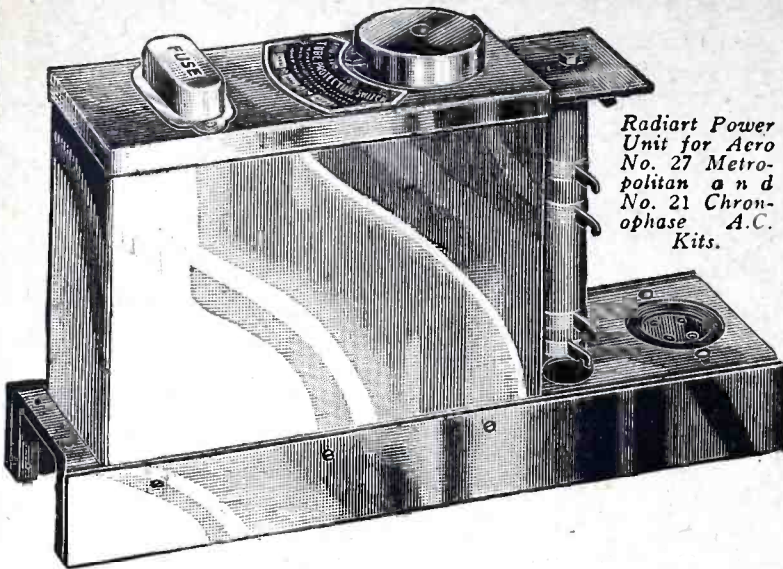
Since the dawn of Radio, Barawik has been known the world over as headquarters for radio set builders and fans. Here, under one roof, is everything you need—sets, parts, supplies—thousands of products—ready to ship to you the same day your order arrives. Barawik prices save you money. Barawik service saves you time. Barawik merchandise always pleases. A quarter million satisfied customers say, "Barawik is Best." Let us send you the Big Barawik Book free and prove it to yourself. **BARAWIK CO. 412-E CANAL ST., CHICAGO, U. S. A.**



Mail This Coupon Now for Free Radio Guide

Name .....  
Address .....

## A, B & C Power Supply for Aero 4 & 5 Tube A.C. Kits



Radiart Power Unit for Aero No. 27 Metropolitan and No. 21 Chrono-phase A.C. Kits.

**Price \$34 Each**  
An Engineering Triumph  
Size Only 3"x7"x11"  
Fits Inside Aero Cabinet

EXACTLY supplies all filament voltages for the No. 280 Rectifier Tube, the No. 227 A.C. tubes and the No. 171 power tube. Also supplies the absolutely correct B voltages for all of the tubes. Also EXACTLY supplies the very important C bias voltage for the No. 171 power tube insuring the full power and truly beautiful tone quality of which this tube is capable when A, B and C voltages are all absolutely EXACT as specified by the tube manufacturers. These power units are special jobs. They are built for the exact and specific requirements

of the Aero 4 Tube No. 27 Metropolitan A.C. Receiver Kits and the Aero 5 Tube No. 21 Chrono-phase A.C. Receiver Kits. They are the result of many months of the combined efforts of Aero Engineers working in co-operation with Radiart Laboratories Engineers. Order Radiart Power Unit No. 44 for the 4 Tube Kit or Radiart Power Unit No. 55 for the 5 tube Kit. Order Aero Metal Cabinet No. 400 for the 4 Tube Kit. Order Aero Metal Cabinet No. 250 for the 5 tube Kit. Order Aerovox Filter Condenser Block No. BC-280 for either the 4 or 5 tube Kit.

Radiart Power Units for Aero A.C. Kits can be obtained from all distributors of Aero Kits. If your dealer is temporarily out of them they will be shipped direct on receipt of price. Address

**Radiart Laboratories, 1003 Association Bldg., Chicago, Illinois**

A few words regarding possible troubles may not be amiss before closing. The Aero "Metropolitan" Shield Grid Model is probably subject to less trouble than any other receiver. There is no neutralization to worry about and as only a two gang condenser is used, its synchronization is easily accomplished with a midget which comes through the panel, but which should require almost no attention after once being set. Regeneration and volume control is accomplished by the new system, which owing to its brute force characteristic will positively stop oscillator or produce regeneration almost regardless of poor wiring jobs. The grid leak is permanently soldered into place underneath the set and therefore will give no trouble, due to oxidized contacts. The C bias for the UX-222 tube is automatically provided.

The other two models present a trifle more difficulty in adjustment but are equally smooth in their operation. The only difference is that neutralization is required. The easiest way to neutralize a receiver of this type is to tune in a very loud local station and then bring out one of the heater leads or one of the filament leads. Wait until the tube has been out for two or three minutes until the emission has completely stopped. Now adjust the neutralizing condenser until the signal disappears. This adjustment should be done with a stick of wood sharpened to a screwdriver point and the operator's hand should not be brought within five or six inches of the neutralizing condenser while adjustment is being made. After the signal has been eliminated by this method, turn the midget condenser until the signal is again heard. Readjust the neutralizing condenser for the silent tune. After a few such adjustments in tuning a point on the neutralizing condenser will be found where there is no signal whatever. At this point the receiver is perfectly neutralized and the filament lead can be reconnected and the set put into operation.

For use very close to broadcasting stations the antenna should be attached to tap No. 1. No other connections whatever should be made to the antenna coil except to taps Nos. 5 and 6. If a short antenna is used, it can be connected to tap No. 4, the balance of the first coil to which the antenna is connected will give a number of combinations, resulting in an unequal flexibility which assures ample selectivity to the metropolitan and very unusual distance to the suburbanite.

Early tests on models of these receivers assembled by inexperienced radio fans have shown it to be the ideal set for metropolitan conditions. Ample selectivity to fully separate the most congested stations can be obtained as witnessed by the set's performance on a 200-foot aerial in the heart of Chicago swarm, while its ability to secure distance is best evidenced by a list of over seventy-five stations from coast to coast secured in one evening with a set-up in a country section of the Middle West.

Additional tests have been carried out in other congested areas, and excellent selectivity was constantly available. The high selecting power does not impair the sideband characteristics of the radio frequency system.

### ENJOY THE THRILL OF ELECTRIFIED RADIO at SMALL COST



Banish forever all the annoyance and expense of buying new "B" Batteries with a TOWNSEND "B" POWER UNIT. Hooked up in a few moments—and you have permanent power from your light socket from that time on. Use same tubes now in your set. No changes.

You'll be amazed at the way Townsends improve your reception and add to distance getting. More than 50,000 now in use. Send Coupon today for full information and free trial offer.



TOWNSEND LABORATORIES  
Chicago Illinois

**COUPON** 11-38  
Townsend Laboratories, Dept. 22 713 Townsend St., Chicago, Ill.  
Please send me full information on the Townsend "B" Power and Free Trial Offer.

Name.....  
Address.....

## Wholesale Prices on RADIO

Get our big new 1929 Radio Catalog—hot off the press. Contains thousands of amazing bargains. Latest, nationally advertised Radio equipment. Latest in Ham Transmission equipment. Everything at lowest wholesale prices.

**NEW RADIO CLUB—Big Prizes**  
Get all the facts about "Ether Trappers" Club, now. No dues. Many advantages. Write for **FREE** Membership at once.

This Big Book of money-saving bargains is yours **FREE**. A regular Radio encyclopedia. Write today for your copy of this book.  
AMERICAN RADIO & MERC. CO.  
Dept. 21  
American Radio Building  
KANSAS CITY, MO.



## A REAL SPECIAL OFFER!!



### UNI-RECTRON POWER AMPLIFIER

(Ideal for use with Dynamic Speakers)



As the Uni-Rectron stands it is a super power amplifier, which can be used in connection with any radio set and loud speaker. Binding posts are provided for input to the Uni-Rectron and output to the speaker. Requires no batteries for its operation. It obtains its power from the 110 volt 60 cycle alternating current lighting circuit of your house.

Model AP-935



List Price \$88.50  
(without tubes)

**Special \$19.75 ea.**

Every one new and packed in original factory cartons

**AMERICAN SALES CO., 19-21 WARREN ST., NEW YORK CITY**

The UX-210 super power amplifying tube and the UX-216B or 281 rectifying tube are used with this amplifier, which cannot overload. From the faintest whisper to the loudest crash of sound—R. C. A. Uni-Rectron amplifies each note at its true value. High and low notes are all treated alike. The volume and quantity delivered will be a revelation.

# Let Me Start you in this ~ Amazing new Business Of your Own ~ Now!

**\$5.00**  
DOWN STARTS  
YOU

## MAKE \$5,000 TO \$15,000 A YEAR in Your Own Home, Basement or Garage Charging and Re- pairing Batteries

Here's your great opportunity to get into a Big Pay field that's growing by leaps and bounds—charging and repairing batteries. A \$5 deposit brings all the tools and equipment to get started in a real business of your own that brings you \$5,000 to \$15,000 a year. Clip coupon below and get complete facts.



Address me Personally. C.F. Holmes, Chief Engineer, Independent Electric Works, Dept. 89, 5116 Ravenswood Ave., Chicago, Ill.



**\$950 IN 5 WEEKS FOR TREGO**  
"I never dreamed money was so easy to make. Your charger has given me independence I never before enjoyed."

### Pocket 90c Clear Profit on Every Battery

I have invented a new Service Station Charger which saves 40% to 60% in electric current, yet handles 50% to 70% more batteries than similar outfits. Millions and millions of batteries in daily use by auto owners everywhere. Amazing new principle of my Service Station Charger simply scoops up all the business in town for you. My Free Book tells you how to get started.

### \$5.00 Is All You Need to Start

Clip coupon and get your Free copy of my book "Big Profits." Read how hundreds of other fellows like yourself have established themselves in their own business. See the description of my amazing Service Station Charger. Find out about my plan for establishing you in this Big Pay field for only \$5. Along with the charger goes my complete outfit of tools, supplies, testers, advertising—in fact everything that you need to do business—you can take in \$20 a day or more right from the start. Get your copy of this book quick.



**\$85 a WEEK FOR McDERMOTT**  
"You are the best company I ever dealt with. My own station is now bringing me in plenty of money, with practically no effort."

### No Experience or Education Required

Why go along at \$25, or \$30 a week when the battery fields holds out an opportunity for you to make upwards of \$5,000 a year? Easy to get started with my charger. When the outfit arrives, you're all ready to begin business. Simply let the business roll in. Charger is automatic and requires no attention during operation. Profits go into your pocket without effort on your part. Free Book tells how.

### Free Advertising, Tools, and Working Outfits

As an owner of my charger you get the benefit of my advertising. When you open up, customers come right to your door. No soliciting—no plugging for business. Everybody is more than anxious to give you their trade.

### Operate in Full or Spare Time

At first you can still work on your regular job. Go to your job in the morning and your batteries will be fully charged when you come home. You can make more money in this way during your spare time than at your job. Free book explains just how to do it.



**\$425 IN 18 DAYS FOR WHALEN**  
"I am now making money easier than at my job. Thank you for the wonderful prosperity your charger has given me."

## GET YOUR COPY OF BIG PROFITS

Over 100 Illustrations

Find out the facts for yourself without one cent of expense. Read what the other fellows are doing. Let me show you how easy it is to get started—with only \$5.00 and how quickly you can build up your own business netting you \$5,000 to \$15,000 a year. Clip and mail coupon now.

Address Me Personally

C. F. HOLMES, Chief Eng.  
Independent Electric Works, Dept. 89  
5116 Ravenswood Avenue  
Chicago, Ill.



**7 BIG FREE OUTFITS for Quick Action**



### Clip Coupon Quick ~ ~

C. F. HOLMES  
5116 Ravenswood Ave., Dept. 89  
Chicago, Ill.

Rush me by return mail a copy of your Free Book "Big Profits."

Name.....

Address.....

**If you are earning Less than \$90.00 a week mail Coupon**

## THE ONLY UNIT THAT COMPLETELY LINKS THE RADIO RECEIVER TO THE LIGHT SOCKET

**Price  
List  
\$5.75**



The new X-L Link makes possible the operation of a radio receiver entirely from one wire leading to the light socket, eliminating all other connections to the set whatsoever, and protects the tubes and parts of the set from injury.

It combines the following—

- Antenna and Ground (using the shielded light wires; increases selectivity and reduces all types of interference).
- Line Voltage Regulation (Protects tubes and set from line voltage surges and prolongs life of tubes indefinitely).
- Double Socket Outlet (For set and dynamic speaker, or power units if used; switch controls dynamic speaker)
- Complete Fusing (Eliminates fire hazard and protects delicate instruments of set from burn-out).
- Control Switch (Exclusive feature. Turns dynamic speaker on and off and controls set if power units are used).

Made with buffed silver finish and brown bakelite trim. Beautiful in appearance and performance. Unqualifiedly guaranteed by the makers of X-L Vario Denser.

# X-L LINK

**X-L RADIO LABORATORIES**  
Department E  
1224 Belmont Avenue, Chicago, Ill.

## The Business of Selling Custom-Built Sets

(Continued from page 51)

practically no investment required, and with headquarters in a choice business location where customers came to him. Besides assembling and installing sets for the ordinary broadcasting wavelengths, he is making a special and successful effort to interest customers in short-wave sets. He is pulling the radio department's summer business up to a higher level, and he has all the work he can handle at home outside of business hours.

Wilson's method of selling custom-built sets is to give demonstrations at institutions or in public places. He tried it first at a school. The teachers were wishing that the school was equipped with radio so that the pupils could hear the Damosch concerts. Wilson offered to install a set for the first concert. The teachers were so delighted that they wanted to kiss him. Maybe they did! Anyhow, he loaned the set seven times in the same school and made enough sales so that it was a good investment. It looks now as though he would land a contract to build a master receiver for the school and install twenty loud speakers in the different classrooms.

Avery, a set builder who is near enough to Cortlandt Street to buy his parts there, makes his sets sell themselves by their superior quality as compared with factory-built sets at the same price. He discovered in his shopping that Walthall's and other big concerns on Cortlandt Street often sells parts at prices lower than manufacturers make to jobbers. Their purchasing power is larger than that of any jobber and they buy at the lowest prices. Their turnover is rapid and they can afford to sell at small mark-ups.

Avery watches the stores and picks up good parts when they are cheapest. The same practice is possible in any city where there are large radio shops or chain stores with radio departments.

Cortlandt Street itself has a method that could be used to good advantage by a custom set builder in any city and in some of the larger towns. M. Hirsch, of the Arrow Radio Company, at No. 83, placed a set builder in one of his show windows. He displayed a sign stating that any customer who purchased parts for a set at his store could have the set assembled, then and there, free of charge.

Mr. Hirsch thought that by having a man at work in the window assembling sets he could attract a crowd and sell more parts. He did! In a short time he sold over three hundred sets of parts for short-wave adapters, in addition to many short-wave sets, sets for the ordinary broadcast wavelengths, and power packs.

Cohen uses the auction method to move goods quickly. Like most custom set builders he is not a good auctioneer himself but he always can find one. He finds that it is not necessary to have a large stock of sets to auction off. When he has accumulated a dozen sets, new or used, he has an auction.

# Carter

## Products STANDARD MERCHANDISE

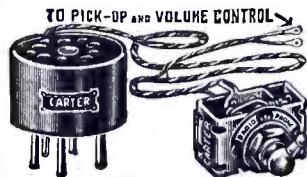
### Carter Voltage Dividers *Steel-tube Type*



These units possess the following advantages: Low operating temperature, exact in rating. Non-breakable (the

base is a steel tube). They are not likely to burn out on overload. Produced in all standard sizes.

### Carter Radio-Phono Attachment



Makes it simple to reproduce phonograph records through your radio set. No wiring changes necessary. Supplied in two types (for four-prong or five prong tubes).

### Carter Radio Outlet Plates

Carter plates are made in sixteen different styles and combinations to meet all usual installation requirements. Specified and used by modern architects and contractors. Write for our attractive booklet. It carries practical suggestions on how to use these conveniences to advantage.



### "The Majority's Choice"

#### Carter Tip Jacks



For standard loud-speaker cord tip terminals. Mounts in 1/4" holes on panels up to 3/16" thick. Heads are coded for easy identification in the following colors: Silver, Red and Black.



**Carter Radio Co.**  
CHICAGO, ILL.

The Majority's Choice

### SEND FOR NEW RADIO BOOK—IT'S FREE!

New hook-ups. This book shows how to make short-wave receivers and short-wave adapters. How to use the new screen grid tube in D.C. and A.C. circuits. How to build power amplifiers ABC eliminators. Up-to-the-minute information on all new radio developments. It's free. Send for copy today.

**KARAS ELECTRIC COMPANY**  
4037-MI-North Rockwell St., Chicago, Ill.

Name .....

St. and No. ....

City and State .....

4037-MI

## BARGAIN/ ONLY 39¢

### GUARANTEED RADIO TUBES

For clear reception on world news, market news, etc., your radio set should have new tubes. Why pay \$2.00? Here's the chance to get guaranteed high quality 201A type radio tubes for only 39¢ each. Send check, money order, or sent C. O. D. Send for Free Radio Guide. These bargain tubes and other bargains are shown in Barawik's Big Radio Guide. Send for free copy today—now! Thousands of other radio bargains—newest coast-to-coast sets, speakers, parts, supplies—all at lowest prices.

Send Now for Free Radio Guide

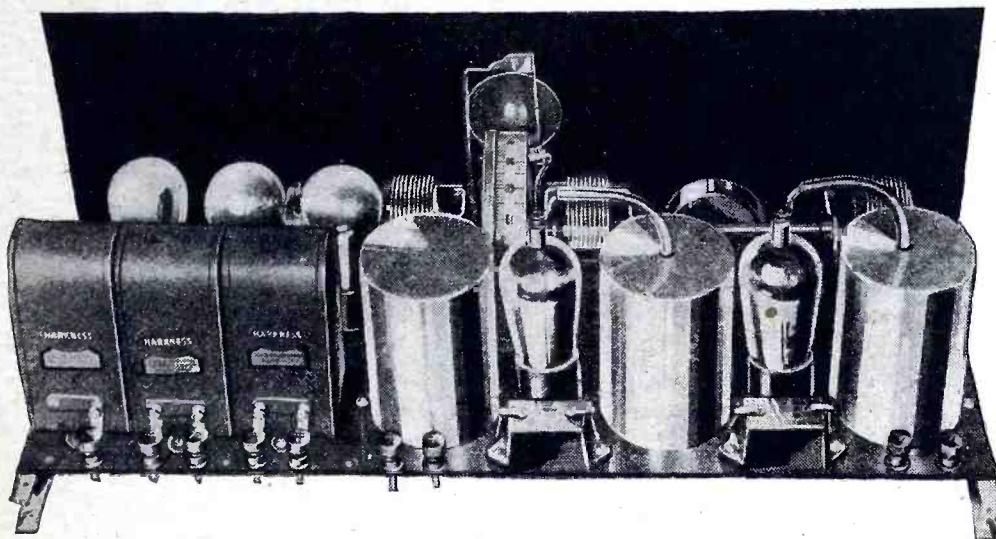
**BARAWIK CO.** 412-G Canal St., CHICAGO, U.S.A.



# HARKNESS

1929

## SCREEN GRID DE LUXE



*Tremendous*  
**AMPLIFICATION!**  
*Amazing*  
**SELECTIVITY!**  
The Outstanding  
**"SCREEN GRID"**  
**RECEIVER**  
of 1929

*Complete*  
*Kit of Parts*

LIST PRICE ★  
only \$ **59** <sup>90</sup> -

### Most Sensitive 5-Tube Set Ever Designed

**H**AVEN'T you always wanted a receiver which really gets distant stations when you tune for them?

Of course you want to get nearby stations with good tone quality and without interference. Almost any modern set will do that. But here's a receiver which will not only get all the locals with marvelous tone quality but will cut right through interference and bring in far distant stations with loud-speaker volume.

As a distance-getter the new HARKNESS "Screen Grid de Luxe" knows no equal in its price class. It is guaranteed to be the most sensitive 5-tube set in existence. It is actually more sensitive than most seven-tube sets.

In the Harkness laboratory, New York, the "Screen Grid de Luxe" is on demonstration every day. Hundreds of local set-builders have visited this laboratory and listened to the reception of distant stations all over the country. In one evening 37 distant stations were logged between 8 and 10 p. m. Many of these stations are received regularly and are tuned in about as easily as locals. Cincinnati, Schenectady and Philadelphia have all been received in broad daylight! If the set can do this in the downtown section of New York, where receiving conditions are extremely poor, you can well imagine how it performs in locations where receiving conditions are half good instead of all bad.

#### Enormous R.F. Gain

##### Stable, Non-Oscillating Circuit

The amazing sensitivity of this receiver is obtained by the use of two screen grid tubes in a new and highly efficient circuit just developed by Kenneth Harkness. The tremendous amplification of screen grid tubes is utilized to the fullest advantage. Weak signals of distant stations are magnified hundreds of times and reproduced with loud-speaker volume. The set reaches out

and brings in stations from all over the continent, stations you could not possibly hear except with the most expensive super-heterodynes.

This extreme sensitivity is obtained without oscillation. It is not the critical, unstable sensitivity of tubes forced to the oscillating point—but sensitivity obtained with a stable, non-oscillating circuit. No experience is required—anybody can turn the single knob of the "Screen Grid de Luxe" and bring in distant stations with ease.

#### Perfect Selectivity

##### Gets Distance Through Locals

Even in congested districts like New York and Chicago you can cut through the locals and get distance every night. The sharp tuning is obtained by the use of special r.f. transformers, designed for this set. These coils make the set extremely selective.

#### Realistic Tone Quality

##### New Patented Audio Amplifier

The reproduction is amazingly realistic. The new, patented system of "tuned double impedance" audio amplification is used. The undistorted power output is four times greater than with any other system. Voice and music are reproduced with a more natural, life-like quality than has ever before been achieved.

#### A.C. and Battery Models

To meet your local requirements, there are two models of the "Screen Grid de Luxe." The battery model is for use with A and B batteries or eliminators. The A.C. model is for use with A.C. tubes throughout.

#### Low Building Cost

With all its remarkable advantages the HARKNESS "Screen Grid de Luxe" costs

less to build than an ordinary 5-tube set. It is one of the lowest-priced kits on the market. It can easily be built by the man of average means and it will more than satisfy the requirements of the man who could afford to spend much more.

#### Easy to Build

You need little or no experience to build this set. Our complete kit contains all the parts required. The front and sub-panels are completely drilled and engraved. Instructions for assembling and wiring, with schematic and picture wiring diagrams, are enclosed with each kit of parts. You can easily build the receiver in one evening.

#### Opportunity for Set-Builders

If you build sets to sell, specialize in the HARKNESS "Screen Grid de Luxe" and you will make real money. The set sells itself on demonstration and stays sold on its wonderful performance. You can sell it profitably at the same price as the cheapest good sets while its performance equals receivers selling for twice as much as you ask. We will co-operate with you and help you sell. Check coupon below and let us quote you our wholesale prices.

#### MAIL COUPON NOW

Write your name and address on the coupon below and mail it to-day. We will send you our illustrated folder describing the "Screen Grid de Luxe" in more detail. Write us a letter or post-card—or use the coupon below.

**KENNETH HARKNESS, Inc.**  
Suite 606-C

72 Cortlandt St., New York City

### MAIL THIS NOW!

KENNETH HARKNESS Inc.,  
Suite 606-C, 72 Cortlandt Street, New York City.

You may send me your free illustrated folder describing the battery and A.C. models of the new HARKNESS "Screen Grid de Luxe" and giving the circuit diagrams.  
 Check here if you are interested in our proposition to custom set-builders.

Name .....

Full Address .....

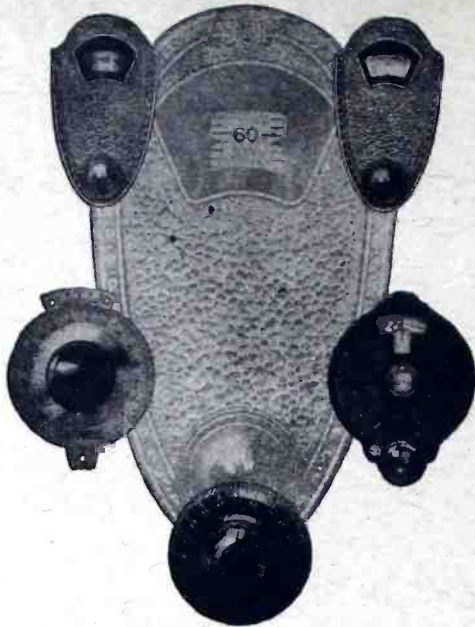
City ..... State .....

\* Standard discount from this price to dealers and professional set-builders. Check and mail coupon for details.

New York Set-Builders: You are cordially invited to visit our laboratory, 72 Cortlandt Street, and hear the "Screen Grid de Luxe" in operation.

**FREE!** Mail coupon for literature and full details

# For Every Radio Use



**TYPE F**  
Velvet Vernier Drum  
Dial. List Price \$4.00  
Type 28 Illuminator .50

**TYPE E**  
Velvet Vernier Single  
Dial. List Price \$2.75  
Dial Illuminator .50

**TYPE N**  
Precision Velvet Vernier  
Dial. Solid German  
Silver. 4" Diameter.  
List Price \$6.50

**TYPE B and C**  
Velvet Vernier Dials  
Type B (nickel)  
List Price \$2.50  
Type C (nickel) with  
bulb. List Price \$3.00

Type A—The Original Velvet Vernier  
Dial. 4" Diameter. List Price \$2.50

Send for Bulletin 121-RLG

## NATIONAL

### VELVET VERNIER DIALS

NATIONAL CO. INC., W. A. READY, President MALDEN, MASS.

The people who attend develop a desire for things that they never dreamed of wanting before. Sometimes they bid sets up to price that they would not pay at a regular store.

Even more spectacular than Hirsch's method is that of Sam Weiss, whose shop is at 81 Cortlandt Street. Mr. Weiss says that he originated the aeroplane or balloon cloth loud speaker. In proof of his statement he exhibits his first model, built three years ago.

This loud speaker is very easy to build as most set builders know. The balloon cloth or airplane fabric is stretched on a wooden frame and tacked fast. A Grebe BBL unit is attached to a board which is fastened to the back of the frame. The pin is inserted through the center of the cloth. The cloth is then treated with airplane dope.

That is about all there is to the assembly, and many builders would have stopped there, but this is where the genius of the method employed by Mr. Weiss appears. Beside the man who assembles the speakers, he has installed a girl. She is easy to look at and she wields a facile paint brush. Her mind seems to be full of beautiful landscapes.

All day long she entertains the passing throngs by painting pictures on these loud speakers. They are genuine talking pictures. As talking pictures are the present craze in the movies, they sell themselves. Mr. Weiss sells a kit for an aeroplane speaker for \$1.69 to customers who prefer to make their own.

He is not resting on his laurels. Already he is at work on a new novelty, a Japanese umbrella with a loud-speaker unit attached. The umbrella-type aerial has been known in radio for more than a decade, but this umbrella-type loud speaker will be a new thing.

Probably the simplest, easiest and least expensive way of advertising custom-build radio is to assemble sets, power packs and loud speakers in view of the public. A man at work in a window will stop more passers-by than any known device except a girl at work in a window.

## The Sargent-Rayment Seven

(Continued from page 76)

control when changing from local to distant reception, it is found that distant stations have a remarkable tendency to come in, with the same setting of volume knob, almost as loud as local stations. The reason for this condition is probably to be found partly in the design of the special coils used in the receiver, and partly in the complete shielding used. In any event, it forms a most satisfying element of added convenience in using the receiver, even though it was not one of the primary objects aimed at in the design.

The thick aluminum shielding plates which form such an essential part of the plan of the receiver, build up into the cabinet shown in the photograph—no other cabinet being required, although many of course, build the Sargent-Rayment kit into a console or other "furniture" cabinet.

# Radio HEADQUARTERS

The newest radio wrinkles—A-C, grid tube, short wave, television, dynamic speakers, newest tubes and circuits—anything and everything in radio—are now ready for you at Barawik's. With big news, football, National broadcasting, Roxy and other big doings filling the air, thousands of newcomers will take to radio this year as never before. Business will be good—Set builders will make money. You can clean up big by buying from Barawik—the oldest, biggest, most reliable radio house in the world. Let us prove it. Send now for the Big Book—all ready for you—free. Get the latest radio information and lowest prices.



**BARAWIK CO.**  
412-K CANAL ST.,  
CHICAGO, U.S.A.

This Big Book Sent to You Free

FREE BOOK

Name.....  
Address.....  
City.....

## Set Builders

You can obtain the parts specified for all circuits featured in this publication, as well as those called for by all other radio papers.

Send for our new 1929 Catalog—It's free—We have a real fast shipping service—Don't hesitate—We are in business since 1897—(31 years of service to the trade).

**Royal-Eastern Electrical Supply Co.**  
18 West 22nd St., New York City, N. Y.

## YOUR BODY

Visit your news dealer today. Ask him to show you a copy of YOUR BODY. It is really a very interesting magazine.

### Contents of the Winter Issue:

- Sex Customs & Superstitions of Primitive Races  
By Dr. William Lemkin
- Before the Baby Comes  
Sex Education Should Begin at an Early Age  
Reproduction in Man and Animals  
Frigidity and Impotence  
By Dr. David H. Keller
- How and Why We Get Hungry  
By Professor A. T. Carlson
- The Truth About Rejuvenation  
By Dr. F. Damrau
- The Art of Medicine in Ancient Greece  
Origin and History of Eye Glasses  
Psychoanalysis  
By Dr. David H. Keller, M.D.
- Evolution  
By William M. Butterfield
- Freaks  
Vitamins  
By Dr. William Lemkin
- How the Catarrh Originates  
The Control of Diabetes  
Eczema and Its Various Forms  
Whooping Cough and Its Treatment  
Is a Medical Cure for Tuberculosis in Sight?  
By Dr. F. Damrau

"YOUR BODY" treats of all the vital elements of life as related to the Human Body. Sex, Psychology, Treatment of all maladies, the senses, our instincts—all are fully explained in the plainest of untechnical languages. Go to your News Dealer today and obtain a copy of "YOUR BODY." If he cannot supply you send fifty cents with the coupon below and we will send you a copy of the Winter Issue by return mail.

**50c**

THE COPY

At all newsstands or write direct

Coupon  
EXPERIMENTER PUBLISHING CO., Inc.  
230 Fifth Avenue, New York, N. Y.  
Gentlemen:  
Enclosed find 50c for which please send me a copy of your big quarterly magazine "YOUR BODY."  
Name.....  
Address.....  
City.....State.....

# Dependable Parts for Modern Sets

## Junior Rheostats



Small in size, but a master instrument. Ask your dealer to show you the exceedingly fine adjustment and velvet smooth action. Diameter, 1 7/16 inches.

- Up to 400 ohms ..... \$0.75
- 1,000, 2,000 and 3,000 ohms ..... 1.00
- Potentiometers ..... extra .25
- Self-attaching, positive-acting switches for Junior Rheostats ..... .40

## Colored Phone Tip Jacks



Have distinctive colored caps, red for positive side of loud speaker and black for negative side. Cap is of Bakelite. Take standard Phone Tips. Phone tips nest all the way in Jack, making excellent spring contact. Lessens danger of shorts. For Bakelite or metal panels.

No. 422—Insulated Colored Phone Tip Jacks, Per Pair ..... \$0.25

### Phone Plugs

Automatic Power Relays

Air-Cooled Rheostats



are the choice of the leading manufacturers for their most prominent and successful sets.

## Radio Convenience Outlets



Enjoy your radio programs in any room in the house. Put the batteries in any out-of-the-way place. Bring aerial and ground connections to most convenient point. These outlets fit any standard switch box. Full instructions with each outlet.

- No. 135—For Loud Speaker Connections ..... \$1.00
  - No. 136—For Aerial and Ground Connections ..... 1.00
  - No. 134—For Several Loud Speaker Connections ..... 2.50
  - No. 132—12 Conductor—For Power Pack Connections ..... 3.00
  - No. 137—7 Conductor—For Battery Connections ..... 2.50
  - No. 138—For A.C. Connections ..... 1.00
- Also furnished in two, and three-plate gang combinations.

### WITH BAKELITE PLATES

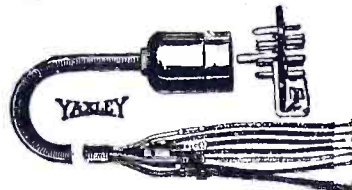
Now furnished with a rich satin Brown Bakelite plate, with beautiful markings to harmonize, at 25c extra.

## Resistance Units



- Absolutely dependable. Run true to rating. Have convenient screw eye and soldering lug for easy mounting and wiring.
- Space wound, 1 to 60 ohms ..... 15c
  - 100 to 400 ohms ..... 25c
  - Tapped resistances, 6 to 64 ohms .... 30c
  - 100 to 400 ohms ..... 40c
  - Grid resistances, 100 to 500 ohms .... 25c
  - 600 to 3,000 ohms ..... 35c

## Cable Connector Plug



Complete as illustrated with 5-foot cable and cable markers. Mounting plate mounts on base panel by means of bracket. Bakelite construction; positive spring contacts; no loosening of pins or springs in soldering. You cannot put the Cable Connector Plug together improperly. All terminals and cable ends plainly marked.

No. 660—Complete ..... \$3.00

### Cable Markers

Panel Lights

Jack Switches

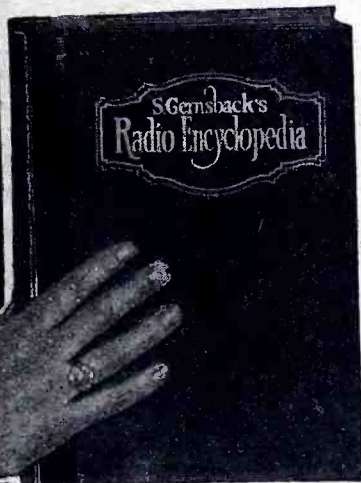
**Yaxley Mfg. Co.**

Dept. I, 9 So. Clinton Street  
Chicago, Ill.

## S. GERNSBACK'S

# RADIO ENCYCLOPEDIA—

*For the fan, service man and professional set builder*



## 2 BEAUTIFUL BINDINGS

Beautiful genuine limp suede edition for those who desire the best. Price, \$5.00.

Handsome Keratol Leather binding, gold embossed cover. Price \$2.00.

S. GERNSBACK'S RADIO ENCYCLOPEDIA will be found absolutely invaluable to service men, builders, and experimenters. Its contents represent years of laborious efforts to gather every possible scrap of information pertaining to radio. There is nothing left uncovered, from the oldest fundamental radio circuits and parts to the very latest information and developments on that kindred art to radio, television. Every known circuit for either a broadcasting or receiving set is dealt with in a highly efficient, readily understandable manner; further, not only is this the most complete encyclopedia compiled, but also, it is the easiest to read and understand. Every definition is given in plain language, the entire work is fully illustrated with diagrams, illustrations of parts and pictures of the men who have placed radio in its present prominent place in industry.

S. Gernsback's Radio Encyclopedia is not a dictionary. It is just what its name claims, an encyclopedia, and conceded to be the leading one of radio. Complete cross index, every topic under an individual heading. Thus, the time required to find any given information is cut to a minimum. There are over one thousand nine hundred and thirty definitions, five hundred and forty-nine illustrations, and many other special features. It is the one book dealing solely with radio that should be in every library.

S. Gernsback's Radio Encyclopedia is printed on fine quality paper with large easy to read type. Two beautiful bindings, each a masterpiece of the bookbinder's art. Size 9" by 12". Order your copy today. Mail the coupon now.

## MAIL THIS COUPON NOW

S. Gernsback,  
230 Fifth Avenue, New York.

Gentlemen:

Kindly send me a copy of S. Gernsback's Radio Encyclopedia. (Check below the binding you desire). I enclose the full purchase price.

Beautiful, genuine limp suede edition (de luxe), \$5.00.

Keratol leather, stiff binding, \$2.00.

**S. GERNSBACK**

230 Fifth Avenue, New York

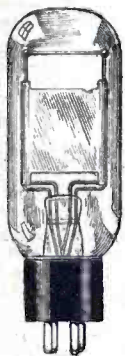
# New!

EDITION

## TELEVISION

*A Magazine for the Experimenting Fan*

"TELEVISION" is a magazine pledged to further the art of the infant industry for which it is named, and to supply the "fans" with the latest information and developments in this fast-growing field. Television, as a science, occupies the same position today as radio did ten years ago. Like the radio fans of years back, enthusiasts of this new field have had to fight for whatever meager knowledge they have been able to obtain. This magazine, then, comes as manna to the information-hungry fan. It is our purpose to keep these enthusiasts constantly informed, through "TELEVISION," of each new development. The second issue of "TELEVISION" is now on the newsstands.



You will find below a partial list of its interesting contents

In the Television field there are all of the thrills that the radio fan knows so well. Get on the band wagon with your fellow enthusiasts. Be the first in your neighborhood to own a television set. Obtain a copy of "TELEVISION"; it will show you how to build a real Television receiver.

The first Television magazine was published by the EXPERIMENTER PUBLISHING COMPANY about a year ago. Over 50,000 copies of this magazine, "TELEVISION," have since been sold. This, alone, is sure proof of the popularity of this interesting new art.

### Partial List of Contents

New Jenkins Radio Movies  
New Belin Photo Transmitter  
Vacuum Cameras to Speed Up Television  
Infra-Red "Eye" Sees at Night  
Valensi Television  
Connection of Photo-Electric Cell

Practical Demonstrations Scheduled for Station WRNY  
Campbell Swinton Television System  
Quartz Crystals Synchronize Television Sets  
Baird Optical Lever Increases Speed  
Recording Pictures with Air Jet  
How to Build a Radio Photo Recorder

and many other articles of equal interest

AT ALL NEWSSTANDS

THE **25c** COPY

OR WRITE DIRECT

EXPERIMENTER PUBLISHING CO., INC., 230 Fifth Ave., New York, N. Y.

EXPERIMENTER PUBLISHING COMPANY, INC.  
230 Fifth Avenue, New York City, N. Y.

Gentlemen: Please forward to me a copy of TELEVISION. Enclosed find 25 cents.

Name.....

Address..... City..... State.....

## The Hammarlund-Roberts Hi-Q 29

(Continued from page 69)

in many distant stations, including one on the Pacific coast. The selectivity was such that more than a dozen of these distant stations were received while the local stations were operating. This test was made last May, using a 75-foot antenna, located in mid-town New York.

The remarkable performance of this receiver can best be understood by a consideration of the principles involved in its design. The interstage radio-frequency transformers are quite unique in that they consist of two exactly similar coils. One constitutes the primary of the transformer and is connected in the plate circuit of the preceding tube, the other coil acts as a secondary and is connected to the grid of the following tube. Each coil is tuned to resonance with the desired signal by means of a .00035 mfd. variable condenser. Due to the rather unusual arrangement, the mutual inductance or coupling between the primary and the secondary is much smaller than used in ordinary circuits. However, this does not mean that the energy transfer from primary to secondary is inefficient. On the contrary, when two tuned circuits are coupled to each other, the maximum secondary voltage, is obtained when the relation  $(6.28f)^2 M^2 = R_1 R_2$  is satisfied where  $f$  is the frequency to which both circuits are tuned,  $M$  is the mutual inductance in henrys, and  $R_1$  and  $R_2$  are the effective radio-frequency resistances of the primary and secondary respectively. In the case of the coupling coils used in the receiver under discussion, the maximum secondary voltage is obtained with a coupling co-efficient of the order of one per cent. The physical arrangement of the coils as shown in the photograph of the completed receiver was chosen because it seemed the simplest way to secure such loose coupling while still keeping the coils close to each other, thus conserving space.

Due to the inherent characteristics of loosely coupled tuned circuits each of these doubly tuned radio-frequency transformers really constitutes a band-pass filter.

One of these double-tuned radio-frequency transformers provides a tapped primary making it adaptable to different length antennas. The variable condenser tuning this antenna coupler is on a separate shaft and has a separate drum dial, thus enabling this circuit to be tuned to exact resonance with the received signal, regardless of the type of antenna used.

The volume control is quite out of the ordinary and is made possible only by the characteristics of the shield-grid tubes. It consists of a 100,000 ohm potentiometer connected across the 45-volt "B" supply. The movable arm of this potentiometer provides a variable voltage which is impressed on the shield-grids of the two R.F. amplifier tubes. The amplification obtainable from these tubes varies within wide limits as the voltage in the shield-grid is varied, being at maximum around 45 volts and drop-

ping rapidly as the shield-grid potential is reduced. This provides a smooth control of volume within wide limits without affecting quality or tuning in the slightest degree.

While the shield-grid tubes have an extremely low value of capacity between plate and grid, thus almost entirely obviating the tendency of feed-back through the tubes themselves causing self-oscillation, this advantage is nullified if feed-back occurs in other parts of the receiver. Taking this into consideration every effort has been made to isolate all circuits in which coupling might result in instability. The negative bias for the control grids of the R.F. tubes is secured by the drop across individual ten-ohm resistors in series with the negative leg of each screen-grid tube filament. Since the screen-grids of both these tubes are biased by the 100,000 ohm potentiometer, a 5,000 ohm isolating resistor is inserted in the lead to each of the shield-grids, which are in turn by-passed by means of separate one-half mfd. by-pass condensers. The plate circuits of these tubes are likewise isolated by individual filters consisting of separate radio-frequency choke coils and by-pass condensers. In addition to the above mentioned precautions the entire R.F. end of the receiver is thoroughly shielded. Each stage is entirely enclosed in a snug-fitting aluminum box which is securely fastened to the metal chassis. The shield-grid tubes are so located that the leads to the control grids are as short as possible and farthest away from the plate leads, which are also short. By placing these tubes between the cans, the can sides are used also as electrostatic tube shields, effectively preventing coupling between the tube elements and other parts of the circuit. This arrangement provides the minimum coupling between output and input circuits, which is extremely important.

The audio-frequency amplifier is of the conventional type consisting of two stages of transformer-coupled amplification. The A.F. Transformers used have a flat frequency characteristic over the usual A.F. range. A radio-frequency choke coil is placed between the plate of the detector tube and the first A.F. transformer to prevent any stray R.F. voltages from getting into the A.F. amplifier. A 171-type tube is recommended for use in the last stage, although other types may be used, if available. A, B and C voltages are available. If 180 volts are used on the plate of the second audio amplifier, break the 135 volt lead going to the screen grid tubes and second audio as shown in the diagram.

In operating the Hammarlund-Roberts Hi-Q 29 receiver it is recommended that either a Knapp or Sterling "A" battery eliminator be employed. A specially constructed Hi-Q "B and C" battery supply unit is also recommended for the set. When using 180 volts or more on the plates of the audio tubes, an output filter should be connected in the circuit between the set and speaker.



## Used by Leaders because They are the Leaders in their Field!—

—with many types of resistances from which to choose, it is highly significant that the most important radio and electrical laboratories and manufacturers in this country have standardized on DURHAM Resistors, Powerohms and Grid Suppressors. The reasons are plain. *First*—there is a DURHAM Resistance unit for every practical need up to 100 megohms. *Second*—the

DURHAM Metallized principle has proved its utter superiority for years. *Third*—DURHAM accuracy and uniformity can be relied upon regardless of the type of unit or the purpose for which it is used. Each succeeding year sees more manufacturers, laboratories, professional radio men and dealers and jobbers endorsing DURHAMS. Descriptive literature on the DURHAM line gladly sent upon request.



INTERNATIONAL RESISTANCE COMPANY, 2006 Chestnut Street, Philadelphia, Pa.



**SENSATION OF THE NATION**

**POLK**

**BINDING POST**

15 Cts. Each

Insulated. No holes to fish for. Insert wire in any position. Quick action and holds tight. Standard markings.

J. L. POLK  
41 Belle Ave. TROY, N. Y.

### More Profits To Set Builders

One good radio idea may be worth millions. Barawik has thousands of ideas for radio set builders to make more money. Barawik's Big Radio Book will help you while elections are on and big national events stir the world.

**LATEST RADIO GUIDE**

Send for your copy today — NOW.

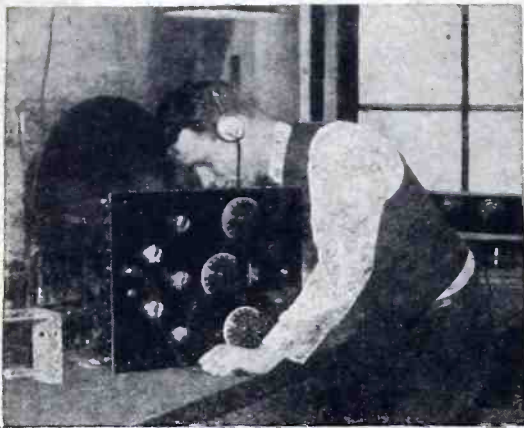
**BARAWIK CO.** 412-S Canal Station, CHICAGO, U. S. A.

Mail This Coupon Now for Free Radio Guide

Name .....

Address .....

# There's money for you in RADIO



*Wonderful opportunity for ambitious men to win success in this fast-growing profession*

THE Radio industry is expanding so rapidly that trained men are at a premium. There is a constant, urgent demand for operators—factory superintendents—engineers—service men—designers—salesmen.

There is no better way for you to succeed in this fascinating business than to study the Radio Course of the International Correspondence Schools. This course is new and complete. It was written by practical authorities in this field. It is endorsed by leading radio experts and radio manufacturers.

Quincy J. Workman, of Scranton, Penna., writes that he has "nearly doubled his salary" since he took up the I. C. S. Radio Course. He is now manager of the Radio Department in a large store.

This same course enabled John M. Paynter, of the U. S. Lighthouse Service, Charleston, S. C., to get a position as Radio Operator and Ship's Electrician. Scores of other men in radio factories, laboratories and stores report similar progress.

You, too, can get in on the ground floor if you act quickly. But don't delay too long. Mark and mail the coupon today and let us tell you all about the I. C. S. Radio Course and what it can do for you.

## Mail the Coupon for Free Booklet

International Correspondence Schools  
Box 7873 Scranton, Penna.

Without cost or obligation, please send me all the facts about the new I. C. S. course in

### RADIO

Name.....

Street Address.....

City.....State.....

## FREE RADIO GUIDE

Radio has been changing so fast lately that it's hard to keep up with it. Barawik's Big Radio Guide will keep you posted on the newest wrinkles. Thousands of illustrations of sets, parts, new ideas. Big chance to save big money. Send for free copy now.

**LATEST RADIO GUIDE**

**BARAWIK CO.** 412-C Canal Sta. CHICAGO, U. S. A.

Mail This Coupon Now for Free Radio Guide

Name .....

Address .....

## Building a Corner Cabinet for the Radio Set

(Continued from page 56)

Using stock straightened and sized to 1½ in. by 1½ in., shape the molded nosing shown in Fig. 13. On the face side, ¼ in. from each edge, plow a groove ⅛ in. wide and 3-16 in. deep, and with chisel and plane round off the section between. Finish by sanding, with the paper backed by a suitably hollowed block. Rabbet the back edge ½ in. by ¾ in., cut to a length of 2 ft. ½ in., and work a tenon ¼ in. by ¾ in. on each end, flush with the rabbet, to fit into the dadoes in the jambs. Glue and nail.



Fastening the hinges on the cabinet.

Size a 1 in. by 2 in. piece to ¾ in. by 1½ in., 4 ft. 3 in. long, fitting the lower end of the countershelf, and nail to the left jamb flush with the inner face. Put a similar one on the other jamb, and cut between these stiles a rail under the edge of the top. This lies flush with the wall-board.

Case up to match the rest of the trim of the room. In this, the lower end of each casing must be ripped to a line scribed to its corner stile, removing ½ in. of stock. Notch ½ in. deeper to fit over the end of the countershelf. The margin on the stile is 1 in. all around.

Miter a 5/8 in. by 6 in. baseboard around the bottom, butting the short returns against the casings, and scribing the little pieces between the casing and the baseboard already on the wall. There, of course, should be the same pattern and width as the old.

Underneath the countershelf projection run a ½ in. by 2 in. backing strip, against which to nail the 5/8 in. by 2½ in. wainscot cap mitered around the edge. Show a margin on the shelf of ¼ in.

Copy the grill design by dividing a 9 in. by 10 in. piece of paper into 1 in. squares, locating the intersections of the curves as they appear in the cut. Trace onto a piece of panel veneer 13¼ in. by 2 ft., one-half the ornament, and reverse the pattern for the other side. Cut out with a bracket saw, smooth the edges with

# Read - - -



## THESE SPECIAL SECTIONS FOR EVERY FAN

Besides the latest set construction articles and editorial matter covering each new development, there are many sections that make RADIO NEWS especially attractive to all radio enthusiasts.

### THE LISTENER SPEAKS

This section belongs to the readers of RADIO NEWS. Its purpose is to provide a common "stamping ground" for the views of the radio public. Here the readers discuss among themselves all questions of interest to radio.

### BROADCASTATICS

A page devoted to humor of purely radio interest. All contributions published are paid for at the rate of \$1.00. There is many a hearty laugh in each issue.

### TELEVISION

A section in which the latest developments of television are reviewed each month. This comparatively new industry is fast gaining popularity. It opens a new field for experimenting to our friend, the "fan."

### WHAT'S NEW IN RADIO

Wherein all new radio apparatus is fully described and its use explained. This section is especially valuable to set builders.

### THE RADIO BEGINNER

As its name signifies, this section is devoted to the radio beginner. All the elementary principles of radio are discussed and full constructional data for the simpler sets given. Full-sized blue prints of the circuits treated are given FREE on request.

### RADIO WRINKLES

This department contains many suggestions helpful to the radio enthusiasts. Each contribution published entitles the author to a year's subscription to RADIO NEWS or, in cases where he is already a subscriber, a year's subscription to either SCIENCE AND INVENTION or AMAZING STORIES.

### RADIOTICS

A humorous page of misprints contributed by our readers. For each one published \$1.00 will be paid, provided that the actual article in which the misprint occurs is enclosed with a few humorous words from the reader.

### RADIO NEWS LABORATORIES

In this section all apparatus awarded the RADIO NEWS LABORATORY CERTIFICATE OF MERIT in the month past, is listed, and a technical description given of its purpose and characteristics.

### I WANT TO KNOW

This department is conducted by Mr. C. W. Palmer. Its purpose is to answer the difficulties of our readers. The value in which the "fans" hold this section can be better realized when one considers that there are over 5,000 letters received from readers each month. Naturally only the more important ones are printed in RADIO NEWS.

Do not neglect to obtain your copy of RADIO NEWS. Each issue over 100 pages. Fully illustrated—large magazine size.

THE **25c** COPY

AT ALL NEWSSTANDS OR WRITE DIRECT

EXPERIMENTER PUBLISHING Co., Inc.  
230 FIFTH AVENUE • NEW YORK, N. Y.

wood rasp and sandpaper, and install by mitring around the edge a 1/2 in. quarter-round. If the speaker is too large to insert from below, put it in and support it on suitable cleats before fastening the grill.

Make a pattern for the brackets, shape them up, and nail under the nosing, 1/4 in. back from the face.

Make two or three shelves to fit the book case section, and hang with shelf hooks inserted in the jamb holes.

The door stiles, and all rails except the 2 1/2 in. lower rails of the long doors, are 3/4 in. by 2 in., with a 3/8 in. by 3/8 in. groove centered on the inner edge of each. Dowel the joints, as indicated in Fig. 14, and assemble with panels cut 8 5/8 in. by 3 5/8 in. and 8 5/8 in. by 1 ft. 4 3/8 in. Assemble the doors and set aside to dry in a flat position.

While waiting for them to dry, scrape out all hammer marks and scratches from the cabinet, and sand well.

Hang the doors with 1/16 in. clearance all around, using 2 in. by 2 in. loose pin butts, placed 1 in. from top and bottom on the small doors, and even with the inner edges of the rails on the long ones. Complete the painting of the cabinet before putting on the catches and the knobs.

Place stops where needed on the radio shelf to hold the set in place.

## The Qualifications of a Radio Service Man

(Continued from page 53)

The characteristics of such items indicating a perfect state or a defective state should be thoroughly understood. The association of such items in conjunction with other equipment should likewise be known. Particular reference is now being made to R.F. chokes, A.F. chokes, bypass capacities and filter systems in "A" and "B" eliminators. It is possible to dwell in this manner for an indeterminate time but the available space is drawing less and less and we must turn to the salesman service man.

Replacement of worn out parts, defective apparatus or apparatus which may be improved upon by the purchase of more modern equipment, is a function of every service man. Promiscuous replacement, however, with the sole idea of effecting a sale with consequent profit, is in the long run very unsatisfactory. With such vulnerable items as vacuum tubes, it is necessary that the service man be certain that tubes require replacement before he recommends such a move. The purchaser must note to his complete satisfaction that the new batch of tubes improve reception. The lack of this state reflects upon the service man and his organization.

It is imperative that the service man be in a position to answer questions pertaining to suggested replacements and in order to do so, he must be familiar with the operating characteristics of whatever replacements he recommends and to feel

# AEROVOX

## BUILT BETTER

### CONDENSERS AND RESISTORS

## How Do You Buy Condensers?



AEROVOX  
FILTER BLOCKS

### The Complete AEROVOX LINE

Includes

#### CONDENSERS

Filter Blocks  
Buffer Blocks  
Socket Power  
High Voltage  
Transmitting  
Bypass  
"A" Power  
Bakelite Moulded Mica  
Condensers  
Interference Filters

#### RESISTORS

Pyrohm Heavy Duty  
Edison Base Pyrohms  
Tapped Pyrohms  
Wire Wound Units  
Grid Suppressors  
Center-Tapped Units  
Non-Inductive Lavite  
Grid Leaks  
Resistoformer Kits  
Resistor Mountings

A Complete Catalog with illustrations and detailed descriptions may be obtained free of charge on request.

Most filter condenser blocks are bought merely on the basis of price and their voltage ratings without due consideration to the fact that voltage rating alone is not a reliable indicator of the ability of a condenser to stand up under all conditions of service.

In view of the many overrated condensers now on the market, the only dependable indicator to use in buying condensers is their insulation specifications and the care with which they are tested.

The Aerovox Wireless Corporation makes no secret of the insulation specifications of their filter condensers and filter condenser blocks. This information is contained in detail in the 1928-1929 catalog.

The next time you buy filter condensers or blocks make your comparisons on the basis of insulation specifications, voltage rating and price. On that basis Aerovox Filter Condensers and Blocks will undoubtedly be your choice.



is a free monthly publication that will keep you abreast of the latest developments in radio. Your name will be put on the mailing list free of charge on request.

# AEROVOX WIRELESS CORP.

## 70 WASHINGTON ST.

## BROOKLYN, N.Y.

### FREE BOOK

**NEW** Hook-ups. This book shows how to make Short Wave receivers and Short Wave Adapters. How to use the new screen grid tube in D.C. and A.C. Circuits. How to build Power Amplifiers, and ABC Eliminators.

Up-to-the-minute information on all new radio developments.

Set Builders, Fans, Dealers, send for it today!

**KARAS ELECTRIC COMPANY**  
4037-M2 N. Rockwell St., Chicago, Ill.

Please send me your Free Book!

Name .....

Address .....

City ..... State ..... 4037-M2

Write for it!

GENUINE **Nathaniel BALDWIN** Regular \$9.00  
Famous Type C

### HEADPHONES

We offer several thousand genuine Nathaniel Baldwin PERFECT Type C headphones fresh from the factory in original sealed cartons at a fraction of their cost. Never before sold for less than \$9. Price while they last only \$5.50, satisfaction guaranteed or money refunded.

**OUR PRICE**

**\$5.50**

**ORDER NOW**

**BALDWIN HEADPHONES**

hold all long distance records; you simply cannot get distance by any other means. An operator at San Francisco picked up a code message from Bagdad, Turkey, half way around the globe, a world's record. Whether you are a professional operator, amateur, experimenter, set builder or B. C. L., these are the headphones you need.

**PREMIER ELECTRIC COMPANY**  
150 Nassau St. New York

# WHOLESALE PRICES

for Dealers, Community Set Builders, General Repairmen and Agents!

NEW ISSUE!  
JUST OFF THE PRESS!

BIG PRICE CUTS

New 75 HOOKUPS  
1500 ILLUSTRATIONS



Our new, HUGE 260 PAGE WHOLESALE CATALOG No. 19 enjoys the enviable distinction of being universally accepted by the RADIO TRADE in the same manner that a school treasures the Dictionary and Encyclopedia Britannica—or the home the Bible and Almanac!!

The preparation and distribution of this MAMMOTH Catalog COSTS A TREMENDOUS SUM—the huge volume of business derived from it warrants this cost as well as the genuine pleasure it gives us to know that those “in the know” regard our catalog AS THE OFFICIAL ORGAN OF THE 1929 RADIO SEASON!!!

This FREE CATALOG is literally a most valuable ENCYCLOPEDIA—YOU cannot well afford to be without one—and, you do not have to. Your request for one is all that is needed! A day or two later, it is in your possession. Surely, a TEST OF OUR PROMPTNESS PLEDGE!

And we are right on the job, ready to supply television apparatus, too! We list more such parts than appear in any other Radio Catalog.

Those having No. 18 Catalog should immediately send for No. 19. ALL PRICES HAVE BEEN REDUCED TREMENDOUSLY!

We can supply any parts and kits described in this issue. Send for prices at once!

THIS 260 PAGE RADIO CATALOGUE FREE

BUY from Radio's Oldest Mail Order House!

In these many years we have been in the Radio Mail Order Business, we have learned from EXPERIENCE how such an organization must be efficiently run in order to GAIN AND RETAIN THE GOOD WILL OF OUR CUSTOMERS. In this, our DETERMINED GOAL, RADIO SPECIALTY COMPANY OFFERS TO SHIP ALL ORDERS IN FROM 6 TO 24 HOURS—OFFERS YOU 100% QUALITY MERCHANDISE ON A STRICT MONEY-BACK BASIS IF NOT THOROUGHLY SATISFIED—AND OFFERS YOU ALL MERCHANDISE AT ABSOLUTE ROCK BOTTOM NET PRICES! Our employees—our executives, are all pledged to handle your every order and inquiry in an intelligent manner. Our 24-HOUR SHIPMENT SCHEDULE MUST BE UNSERVICEDLY MAINTAINED! And to this pledge, we owe our daily increasing patronage. It will pay YOU to be numbered among our many thousands of customers! A trial is all we ask!

"RASCO" has it

And, if we do not list in our catalog your Radio requirements, WE WILL OBTAIN SUCH PARTS, BILLING YOU AT THE USUAL TRADE DISCOUNTS!

OUR CATALOGUE CONTAINS THE LARGEST ASSORTMENT OF RADIO MERCHANDISE IN THE COUNTRY. Only the most successful manufacturers' products are listed—such lines as PILOT—SILVER—MARSHALL—CARTER—AERO—YAXLEY—TOBE—HAMMARLUND—AMETRA—CUNNINGHAM—DONGAN—THORDA—MUTER, etc., etc. THE LATEST IMPROVEMENTS IN RADIO ARE LISTED AND THOROUGHLY DESCRIBED IN THIS GREAT CATALOG: A.C. ALL ELECTRIC Sets with self-contained ABC power supply—Public Address Amplifier systems—A.C. Set Converters—A and B eliminators—Dynamic Speakers and Units—Magnetic Speaker Chasses—250 Tube Amplifiers—Airplane Cloth Speakers—Push-Pull Power Amplifiers—Electric Phonograph Turn-Tables—Combination Radio and Electric Phonograph Consoles—Speaker Tables—Short Wave Sets and Adapters—Shield Grid Tube Kits—Television Parts. LOGICALLY, HOW CAN YOU AFFORD TO BE WITHOUT OUR CATALOG—SEND FOR ONE NOW!



Radio Specialty Co.



102A PARK PLACE, NEW YORK



safe that such replacements will vindicate his judgment. Failure to do so is the surest method of losing public confidence. Many receiver owners are advised to make new purchases, but such advice should be based upon positive improvements. Concrete illustrations of the above are power tubes and loud speakers. Power tubes should be recommended only when the installation will satisfactorily handle the requirements of such tubes. Speakers should be recommended only when the suggested model is superior to the model at hand and when the receiver output is sufficient to satisfactorily operate the more modern or improved speaker.

It is evident from the above that a service man while a mere mortal, must possess a certain amount of technical knowledge and if our experience is a guide, compliance with the qualifications expressed herein is proof of capability.

### The Harkness "Screen Grid de Luxe"

(Continued from page 90)

plates to the r.f. transformers. The capacity coupling between these long leads and between the three sections of the condenser itself was sufficient to produce oscillation. In the new "Screen Grid de Luxe" three separate tuning condensers are used and widely spaced from each other.

The connecting wire from the stator of each condenser to the r.f. transformer is now less than two inches long and these grid leads are several inches apart. It was found that this change in the design of the receiver completely removed the main source of oscillation. It was, in fact, found possible to greatly increase the amplification per stage without producing oscillation. New r.f. transformers were designed which materially improved the amplification. As a result, the receiver is probably the most sensitive 5-tube set which has ever been designed. The pick-up is greater than that obtained with most seven tube sets using 201-A tubes. Moreover, this extreme sensitivity is obtained without oscillation. It is not the critical sensitivity of tubes forced to the oscillating point but sensitivity obtained with perfect stability and ease.

The selectivity is perfect even under the worst conditions. The r.f. transformers have been designed to provide really sharp tuning. In the down-town section of New York City, surrounded by strong local stations, this receiver brings in scores of distant stations every evening, without interference.

As the sensitivity of the set is unusually high, a short aerial is recommended. The best selectivity is then obtained. However, provision is made for obtaining sharp selectivity even if a long aerial is used. A fixed .0001 Mfd. condenser is connected in series with the aerial and this condenser greatly sharpens the tuning. A switch is provided on the front panel to short-circuit the condenser when the set is used with a short aerial or when extreme selectivity is not required.

The improved tone quality of the "Screen Grid de Luxe" is obtained by the use of a "tuned double impedance" coupler in the second stage of the audio am-

# Send For WESTERN RADIO New 1929 Catalog

WESTERN RADIO'S 1929 Big Radio Value Book is ready for you. Bigger, more complete than ever. Popular, *NATIONALLY* known A.C. sets, consoles, dynamic speakers, kits, eliminators and accessories. Largest stock of radio parts for all well known circuits.

### Dealers and Setbuilders

Our big Dealer Catalog offers you tremendous savings. Everything you want in radio is in this big book. Standard quality at prices that are RIGHT. Send for our FREE catalog and save money.

WESTERN RADIO MFG. CO.

Dept. RL-2

128 W. Lake St., Chicago

FREE



## "The Big Friendly Radio House"

**EVERYTHING IN RADIO**  
AT ATTRACTIVE PRICES, SETS OR PARTS  
Orders shipped exactly as ordered. Prompt Service. Write for Prices. Mail Order Only.  
Send Your Address  
ALL RADIO COMPANY  
417 North Clark Street Chicago

**6-Tube Radio Complete**  
\$34.75 to \$66.66  
Licensed R.C.A. Circuits, Shielded. One Dial  
Write for catalog. Big discounts to agents  
CONSUMERS RADIO CO.,  
4721 Lincoln Ave., Dept. 124, Chicago, Ill.

**Newest Information TO SET BUILDERS**

**LATEST RADIO GUIDE**

Elections, football games, big National events will boost radio business this year. Set builders will reap a rich harvest. Barwik service will make you money. Everything in A.C. sets, parts, supplies. World's largest radio stocks on hand. Orders shipped same day. Lowest rock-bottom wholesale prices.

Mail coupon for free Radio Catalog now

**BARWIK CO. 412-H Canal Sta., CHICAGO, U. S. A.**

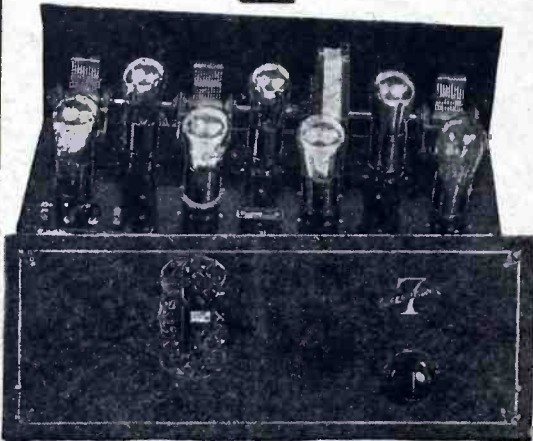
Mail this coupon for Free Radio Guide

Name \_\_\_\_\_

Address \_\_\_\_\_

Radio's  
greatest  
value!

**7**  
SUPERPHONIC



**7**  
**Tubes**  
Single  
Dial

Only  
**\$16.95**

COAST  
& COAST  
RECEP-  
TION

Superphonic 7 is a world beater! An exceptionally high grade receiver that is amazing the Radio World. Latest 7 tube tuned radio frequency circuit using 4 radio frequency amplifiers, detector and 2 stages of audio. Power tube can be used in last audio stage. Extremely selective, marvelous sensitivity. Single drum dial control. Straight line wave length condensers permit accurate, equally spaced tuning over entire wave band. All sockets spring cushioned to eliminate microphonic noises. Bakelite sub-panel (8 1/2" deep) insures minimum dielectric losses. Clear and realistic reception guaranteed. An exceptionally beautiful walnut finish, metal front panel 7"x18". Complete chassis. No extra parts to buy. All parts mounted ready to wire. No special tools needed. All hook-up wire and colored battery cable included. Value \$60.00; our price \$16.95.

#### TESTED AND APPROVED

Severe laboratory tests have proved the remarkable efficiency of this set. Owners everywhere are sending us letters praising its wonderful receptive qualities.

#### SIMPLE WIRING DIRECTIONS

Very easy to wire this set with the instruction we furnish. Just connect a few wires. All you have to do is to follow numbers. Simple as adding 2 and 2. Can be wired in a few minutes by anyone. No radio knowledge needed. Make money by wiring these sets in your spare time and selling them to your friends.

#### SEND NO MONEY

Just write your name and address on a post card and ask us to send you this wonderful outfit. We ship right away. Upon arrival pay only \$16.95 plus a small delivery charge. (Foreign countries send \$19.50 with order. We pay shipping charges.)

#### RADIO EQUIPMENT CO.

549 S. Wells St., Dept. 2-B, Chicago, Ill.

plifier. A transformer is used in the first stage. The combination results in practically uniform amplification over the entire range of audio frequencies. The set delivers clear, undistorted reproduction of voice and music.

Volume is controlled by a potentiometer which varies the voltage impressed on the screening grid of the first r.f. tube. A smooth variation from inaudibility to maximum volume is provided by this control. Even the signals of a strong local station can be reduced to complete inaudibility. The potentiometer selected for this set has been thoroughly tested to make sure that it will not break down after the set has been in use for some time. It has been found entirely suitable for the purpose. This volume control is not needed to suppress oscillation. When used with the rated plate voltage, the set does not oscillate and the potentiometer is merely used to control volume. However, if the voltage impressed on the screening grids is raised from 45 to 57 volts the set will usually oscillate, in which case the potentiometer can be used to control oscillation as well as volume. Ordinarily, this is not desirable.

A point worth noting is that volume is controlled in the radio frequency end of the set. There is, therefore, no possibility of the reproduction of a strong local station being marred by overloading of the detector tube.

The receiver uses single dial tuning. All three tuning condensers are varied by a single control. Provision is made for balancing the three tuned circuits and the single dial is thereby made just as efficient as three separate controls. Across a small "equalizer" each tuning condenser is attached. After the set is wired these three equalizers are adjusted with a screw-driver and perfect tuning is obtained over the entire range of the dial.

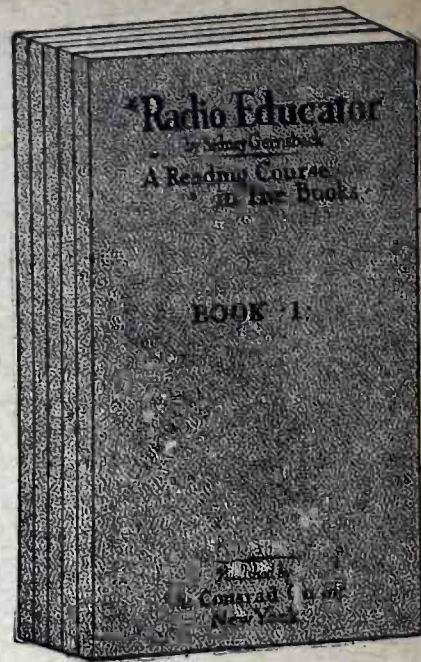
The photographs and diagrams appearing on these pages illustrate the battery model of the Harkness "Screen Grid de Luxe" and clearly show the general assembly and wiring.

To operate the receiver the following accessories are required:

- 2—Type 222 Screen Grid Tubes
- 1—Type 201-A Tube
- 1—Type 240 Tube (or 201-A)
- 1—Type 112 or 171-A Tube
- 1—6v. Storage Battery (or A eliminator)
- 3—45v. B Batteries (or B eliminator)
- 1—C Battery (9v. or 40v.)
- 1—Battery Cable (8-wire)
- 1—Loud speaker.

Any standard make of tubes can be used. The type 240 tube is preferable for the first stage of audio as more amplification will be given. However, a 201-A will serve. Either a 112-A or 171-A can be used in the last stage of audio. If B batteries are employed to operate the set it is better to use a 112 tube. With a B eliminator (up to 180 volts) the 171 tube should be chosen. The voltage of the C battery depends upon the type of tube in the output. With a 112 tube a 9 volt C battery is sufficient; with a 171 tube the C battery must be from 30 to 40 volts.

The batteries or eliminators attach to



Price \$1.97

# A RADIO EDUCATION IN 5 VOLUMES "THE RADIO EDUCATOR"

Theory, Design, Construction,  
Operation and Maintenance

LEARN AT HOME

THESE five component parts of a complete Radio Instruction Course are outlined in five volumes that contain not merely the essentials as so many books do, but more, they contain all that any modern up-to-the-minute textbook on any subject would cover. They are in themselves a COMPLETE radio education teaching every possible portion of Radio science.

Size of each book 6 by 9 inches, handsomely bound and illustrated with charts, diagrams, descriptions of equipment, etc. Each volume 52 pages.

SEND NO MONEY for these books. Just forward your name and address. We send you the books at once. On receipt of same you pay the postman \$1.97 plus a few cents postage and then they are yours.

Distributed by

**The Conrad Co.**

Incorporated

230 Fifth Ave., New York, N. Y.

**Newest Information  
TO SET BUILDERS**

Basketball, baseball games, big National events will boost radio business this year. Set builders will reap a rich harvest. Barawik service will make you money. Everything in A-C sets, parts, supplies. World's largest radio stocks on hand. Orders shipped same day. Lowest rock-bottom wholesale prices.

Mail coupon for free Radio Catalog now

**BARAWIK CO.** 412-M Canal St., CHICAGO, U. S. A.

Mail this coupon for Free Radio Guide

Name \_\_\_\_\_

Address \_\_\_\_\_



the set in the usual manner, as illustrated in battery hook-up herewith.

The antenna should not be more than 100 feet long, including the lead-in. A shorter aerial is preferable. The nearest water-pipe can be used for the ground connection.

After the set is installed, the three tuned circuits must be balanced by means of the equalizers. This is a simple operation but must be done carefully. First push the switch at the left hand side of the panel into the position which puts the fixed condenser in series with the antenna. This position may be up or down depending upon how you wired the switch. Then tune in some fairly weak station between 20 and 40 on the tuning dial. Turn down the volume until the signal is barely audible and again turn the tuning knob until the station is tuned in as loud as can be obtained. With a screwdriver turn each of the three equalizers to the position at which maximum audibility is obtained. Keep turning down the volume so that you can accurately tell whether the circuit is tuned correctly. Perform this operation on two or three different stations to make sure the adjustments are correct. You will find that the third equalizer, across the detector, must be kept at nearly the minimum position while the other two are screwed down considerably more. If you find that the adjustments which are most suitable for stations below 40 on the dial, are not suitable for stations above 70, this is a fairly certain indication that one or more of the tuning condensers is out of alignment. Before placing them in the set these condensers should be examined (with a shaft through the rotor) to make sure that the rotor is exactly in the center of the stator. If not, the screws holding the stator in place should be loosened and the stator moved until the rotor is in the exact center at all positions. If the rotor is off-center the set will not tune accurately.

After the equalizers have been adjusted stations are tuned in by the single tuning knob. No further adjustments of the equalizers are required unless the aerial is changed.

## A High Quality Radio And Phonograph Amplifier

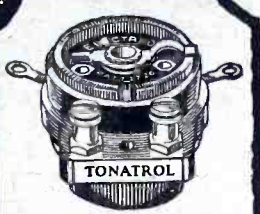
(Continued from page 87)

tem was adopted; in this way only the A.C. signal component circulates through the transformer primary winding.

A little study shows that for such work its inductance and resulting impedance must always be greater than that of the transformer (or choke coil) primary winding it is to work in conjunction with. It is also obvious that the chokes D.C. resistance should be fairly low. Happily, the choke used in this unit meets these conditions.

Any capable engineer appreciates that one must be careful when using high quality amplifier systems in conjunction with high voltage rectifier methods. Otherwise the common impedance path offered

# Sentinels of Satisfaction!

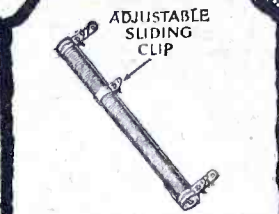


Exclusively Licensed by  
U. S. Pat. Nos. 1593658,  
1034103, 1034104.

## TONATROL

Trade Mark

### A Complete Line of Volume Controls



ADJUSTABLE SLIDING CLIP

U.S. Pat. No. 1676869  
and Patents Pending.

The ace of volume controls—in different types specifically designed for all circuits—A.C. or battery type. With or without filament or power switch as desired, \$1.50 to \$3.00.

## TRUVOLT

### ALL WIRE RESISTANCES


Reg. U. S. Pat. Off.

Unequaled for voltage control in power supply units. Potentiometer type saves difficult calculations. 22 stock types \$3.50 each. Fixed Truvolts adjustable to any values by sliding clip taps. Made in all desirable resistance values and current ratings.

Electrad Specializes in a Full Line of Resistance Controls for all Radio Purposes, Including Television.

Dept. B-12, 175 Varick Street, New York

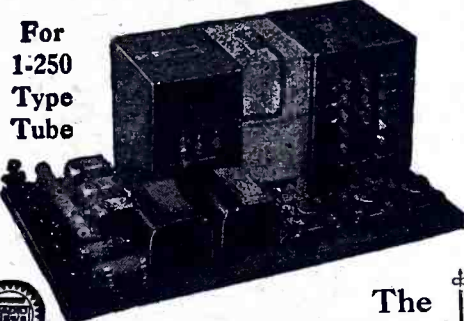
# ELECTRAD Inc.



## New AMPLI-PACK

### Makes Your Set a Modern A.C. Power Receiver

For 1-250 Type Tube



The T. C. A. High Quality Line Also Includes

171 Push-Pull and Straight 210 Power Packs

Audio Transformers

Audio Output Chokes and other Transformers

Write for Free Booklet

A Complete A.C. Power Supply—"A" and "B" and "C"—Makes any D.C. Set into an Ultra-Modern A.C. Receiver. Uses two 210 type tubes in Push-pull; or one of the new 250 type tubes. Power Amplification gives perfect reproduction over the entire musical scale range.

### QUICKLY ASSEMBLED

You can assemble an AmpliPack easily in one evening. We supply complete layout diagrams. Simple to install. Attached to set in three minutes. Consumes no more current than an ordinary 50-watt light. Cool, quiet, dependable.

### ASK YOUR DEALER

Leading dealers can give you full details and our simple assembly diagrams. Don't be satisfied with out-of-date reception—build an AmpliPack tonight!

**TRANSFORMER CORP. OF AMERICA**

1428-32 Orleans St., Chicago, Ill.

**NEW YEAR - NEW IDEA**

**PATENT YOUR IDEAS**

Call or send me a sketch of your invention. Phone LONgacre 3088

**FREE** Inventors Recording Blank Confidential Advice

U. S. and Foreign Patents secured by **Z.H. POLACHEK** Reg. Patent Attorney Consult. Engineer

1234 Broadway, New York

**Before Buying any "A" Eliminator**

Get my authorized Discount Card and complete description of the finest "A" Power Kit ever offered.

**DAVID W. KNAPP, Pres.**  
**Knapp Electric, Inc.**  
Division of P. R. Mallory & Co., Inc.  
Room 415, 350 Madison Ave., N. Y. C.

# Short Wave New Manual

*Full size blue prints  
bound in book*

ONLY 50¢  
THE COPY

Up-to-the-  
minute data  
—All worth-  
while circuits—

Prepared by Eminent Short Wave Experts

Edited by H. M. BAYER, Tech. Editor of RADIO NEWS

This is unquestionably the foremost book on short wave receivers and the theory of short wave reception ever written. The data which it contains is a compilation of the knowledge of an eminent board of Short Wave Experts.

As practically every one today knows, some of the finest programs are being broadcast over the short wave bands. There are many reasons for this. Paramount among them all is the fact that that entertainment, broadcast in this band, can be received over distances which with the ordinary broadcast receiver would be impossible! Thousands of letters, which pour in an unremitting stream into our offices tell the same tale—it is a common and everyday matter to receive programs

**EXPERIMENTER  
PUBLISHING COMPANY, Inc.**  
230 Fifth Avenue, New York



Beautiful  
Colored Cover

from all foreign countries, from the most distant climes. England, France, Germany, towns on the African continent, from every conceivable corner of the globe where a station is located—programs come in with surprising volume and clarity. One would think they were hearing a New York, Chicago or San Francisco station until the voice of the announcer, many thousands of miles away discloses the true location of station.

In the Short Wave Manual you will find complete diagrams, full size blueprints pasted into the book. These tell plainly how to construct all the short wave circuits which our tireless laboratory researches have shown to be most efficient.

The SHORT WAVE MANUAL contains complete information on everything concerning Short Wave reception. Large size book (same size as Radio News) with a beautiful colored cover. Replete with illustrations, diagrams and with FULL SIZE BLUE PRINTS. This big valuable book will show you how to receive all the foreign countries clearly and easily. Write today for your copy.

*Mail This Coupon*

EXPERIMENTER PUBLISHING CO.  
230 FIFTH AVENUE, NEW YORK.

Gentlemen:

Enclosed find 50c for which please send me a copy of THE SHORT WAVE MANUAL.

Name .....

Address .....

City ..... State .....

**first time offered**



**16<sup>50</sup>**  
Complete with 5 COILS

**Shielded SHORT WAVE CONVERTER**

The Only Unit With a Wave Length Range of 15 to 550 Meters

Introducing another triumph for SHORT WAVE reception. Highest efficiency at an amazingly low price, made possible by economic production. Now, all can afford to get the best entertainment of the air being broadcast on short waves by many powerful stations throughout the U. S. and Europe.

**Easy to Attach and Operate**

The new model, Dresner Shielded Short Wave Converter is completely assembled, and may be used on any set. It requires no extra tubes or batteries. It is built in a beautiful mahogany finished metal cabinet. Efficiently covers a wave band of 15 to 550 meters. GUARANTEED to give you highest satisfaction. Take advantage of this special offer at once. If your dealer cannot supply you, SEND MONEY ORDER DIRECT and we will ship at once. (When order unit, be sure to specify whether it is to be used on A.C. or D.C. set).

**DRESNER RADIO MFG. CORP.**  
640 Southern Boulevard,  
Dept. L12, New York  
N. Y.

**Remarkably Low Price**

**GET MY DISCOUNT CARD!**  
Before buying a **KNAPP "A" POWER KIT**  
Absolutely dry—Magically silent—the finest "A" Power adaptable to Short Wave, Super-Heterodyne and Television reception.

**WITH THE 10 NEW IMPROVEMENTS**  
Write me today for details of this money saving plan and get your discount card. Address

**DAVID W. KNAPP, Pres.**  
**Knapp Electric, Inc.**  
Division of P. R. Mallory & Co., Inc.  
Room 415, 350 Madison Ave., N. Y. C.

**RADIO SETS at LOWEST PRICES**

Every farm, every home, every man and woman needs radio this year to follow the news, markets, big national events, football, sports, music, etc. Barawik's Big Radio Guide tells you the best sets, methods and supplies to use and how to use them for best results at lowest cost. Thousands of clear illustrations and latest valuable information, furnished free. Just send for Barawik's Big Radio Guide, the guide to radio and real radio enjoyment. You can get what you want here at biggest savings. Write today for free copy.

**BARAWIK CO.** 412-D Canal St.,  
Mall this Coupon for Free Radio Guide.  
CHICAGO, U.S.A.

Name.....  
Address.....



by the power unit may be of such order as to cause audio frequency oscillation or "motorboating," which of course, will completely change the amplifier characteristics, cause distortion, etc.

It will ordinarily be found that the detector stage proves a principal offender. In the circuit under discussion a "trap circuit" scheme is adopted whereby a simple resistance and shunt condenser are placed in series with the primary winding of the first audio transformer.

Because the plate current of a type 227 A.C. detector tube is somewhat high, this resistor brings about a fairly large voltage drop. However, since a high voltage power unit is employed with the amplifier, this drop can be compensated for by using a detector "B" voltage of either 90 or 135. But in the event that one may care to employ another method free from such voltage loss then it is apparent that a type 103 Amerchoke may be used in place of the resistor.

It also is important to use a suitable number of high quality long life by-pass condensers at certain points of the circuit. It is good practice to note that the leakage resistance be a minimum for the coupling condenser placed between the parallel feed choke and the input push-pull transformer.

In order that various circuits operate with complete stability, metallized grid-leak resistors are placed in the grid circuits of both stages. The use of wire-wound resistors of the Superdavo-ohm type constitute an even better scheme than the cheaper metalized variety.

The photograph incorporated in the heading of this article reveals that practically all wiring is of the twisted pair type. This method proves quite helpful to eliminate stray inductive pick-up of hum and background noises. All A.C. filament wiring going to either the 227 heater type tube or the 210's is kept rather well isolated from the other circuits, and this in a measure accounts for the somewhat open type of construction.

Now just a word with reference to the phono pick-up or equalizer transformer. This unit is equipped with a tapped primary so that this circuit can readily be adjusted for the best load impedance ratio for working out of any high grade magnetic pick-up such as the Stromberg-Carlson, Bosch, Phonovox, Victor, General Electric, etc. It will be necessary to make a simple test for determining best operation.

The entire device as described in the foregoing and shown in the diagrams was assembled on a small 10 by 14 inch drafting board. The photograph shows just where and how each part should be placed. If these designs are carried out, then perfect results will be assured, though, of course certain changes depending upon individual requirements may suggest itself. For example, one may use a D.C. instead of an A.C. tube in the first audio stage.

At this point it may be well to mention that the power amplifier as shown was constructed so that the output push-pull transformer should feed into a high grade electro-magnetic type loud speaker. In this case, a model 152 Amertran transformer was employed. However, should

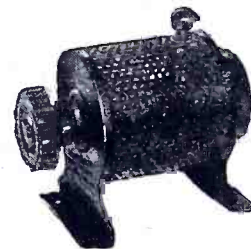
# Radio "first aids"

No matter what your interest in radio may be, whether just an average listener-in or a dyed-in-the-wool experimenter, you must obtain better results if you use Clarostat "First Aids."



For your regular broadcast set—don't fail to use a Grid Leak Clarostat for maximum sensitivity, as well as a Volume Control Clarostat for regulating plate voltage, oscillation and loud-speaker volume and tone. \$1.50.

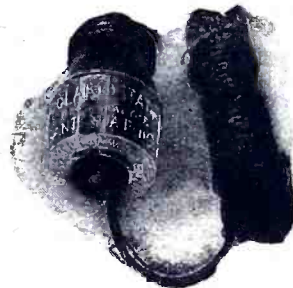
For your radio power unit—apply a Duplex Clarostat for better voltage regulation, for obtaining extra taps, for increasing or decreasing existing taps, and for obtaining C or grid bias voltages. \$2.25.



For television—use the standard scanning disk control—the Speed Control Clarostat, now employed by leading television broadcasters and experimenters. \$5.00.



For loud-speaker control—use the Table Type Clarostat, which can be connected in series or in shunt, nearby or at a distance, for regulating radio volume and tone to fit any occasion. No tools required. \$2.50.



For greater signal strength—try a Clarostat Antenna Plug, the different and improved device which makes an excellent antenna out of any socket or outlet. \$1.50.

WRITE for the Clarostat literature, which tells the story at length on how you can improve your radio results. Better still, send 25 cents in stamps or coin for "The Gateway to Better Radio"—88 diagrams, over 20,000 words, and a wealth of ideas. The best investment you ever made in radio.



**Clarostat Mfg. Co., Inc.**  
Specialists in Variable Resistors  
288 North Sixth St., Brooklyn, N. Y.

**CLAROSTAT**  
Reg. U. S. Pat. Off.

# Thousands Use The *SKINDERVIKEN* TRANSMITTER UNIT



**95c Or Two for \$1.75**

This famous and popular unit has been adapted to hundreds of different uses. Its application to radio, to electrical phenomena and to many unusual and practical household uses is limitless. It is essentially a very powerful amplifier as well as an efficient and dependable transmitter.

The Skinderviken transmitter units are, at the present time, used in numerous radio circuits, they are used for radio transmission, for radio amplification permitting the operation of a

loud speaker from a crystal receiver, for phonograph and loud speaker amplification, for stethoscopes, detectaphones, telephone transmission, etc., etc. Every amateur should have two or three of these units in his laboratory.

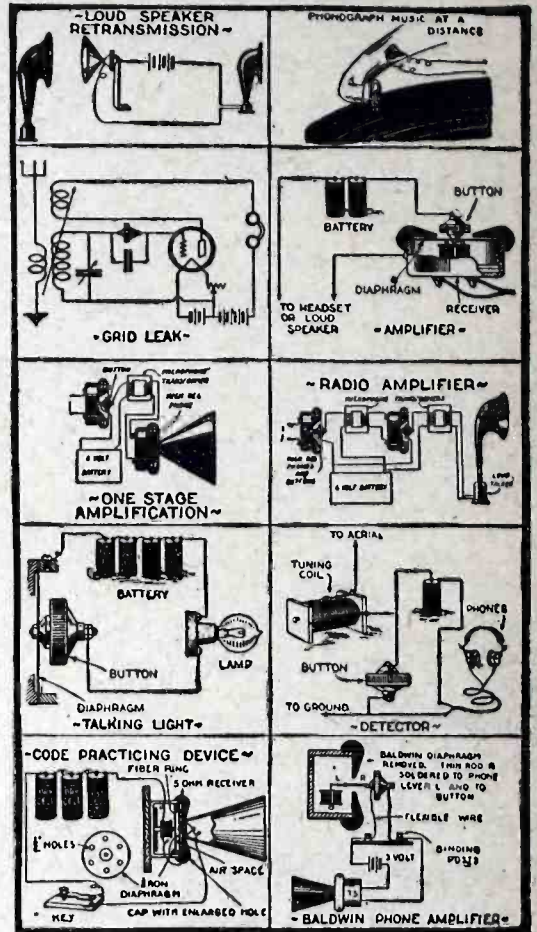
## 12 Page Instruction Booklet Furnished with Each Unit

With each unit is furnished a twelve-page instruction booklet, containing suggestions and diagrams for innumerable uses. Each use in the booklet is explained carefully and illustrated with clear diagrams. The booklet alone is worth the price of the unit.

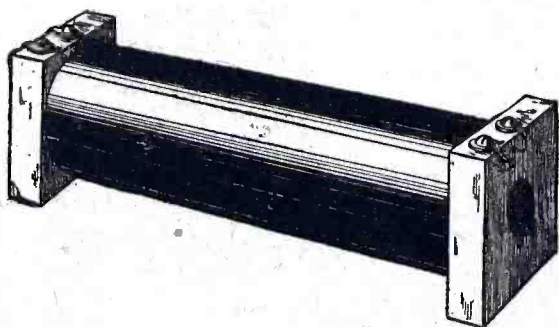
## We Pay \$5.00 In Cash

for every new use developed for this unit and accepted and published by us. There is no limit to the uses to which the Skinderviken Transmitter Unit can be put. Experimenters are always finding new ones. There still remain hundreds of undiscovered applications that can be developed by a little experimentation. Here is your chance to make some money.

### A FEW USES FOR THESE UNITS



# P.G. MICROPHONE TRANSFORMER



A microphone transformer (*modulation transformer*) specially designed for use with the Skinderviken Transmitter. These transformers are used for stepping up the low voltage high-frequency currents from the transmitter circuit, to a slightly higher voltage which will permit transmission over greater distances. The coils have many other uses for experimenters, such as for making small medical coils, etc. Primary resistance  $\frac{1}{2}$  ohm. Secondary resistance 55 ohms.

The 12-page instruction booklet furnished with each Unit gives details and diagrams for a large number of special uses of the Transformer in conjunction with the unit.

**\$2.00**

## Skinderviken Transmitter Units Are For Sale at Following Dealers

The W. T. Grant Stores  
 J. Belmuth, 198 Broadway, New York City  
 Blau, The Radio Man, 89 Cortlandt St., New York City  
 Cameradio Co., 430 Wood St., Pittsburgh, Pa.  
 Chicago Salvage Stock Store, 509 S. State St., Chicago  
 I. S. Cohen's Sons, 1023 Market St., San Francisco  
 Oriental Electric Co., 438 Rizal Ave., Manila, P. I.  
 Radio Centre Corp., 329 W. Baltimore St., Baltimore  
 Radio Dealers, Supply Service, 1142 Market St., San Francisco

Radio Supply Co., 221 S. Boston St., Tulsa, Okla.  
 Wilder Radio Co., 1446 Bleury St., Montreal, Canada  
 Radio Specialty Co., 98 Park Place, New York City  
 Radio Supply Co., 912 South Broadway, Los Angeles  
 Conrad Richter, 1284 Market Street, San Francisco  
 Ben's Tremont El. Supply Co., 228 Tremont St. & 70 Stuart St., Boston  
 Washington Electric Supply Co., 24 Stuart St., Boston  
 Wedel Co., 520-2nd Ave., Seattle

## If Your Dealer Cannot Supply You, Order Direct—Use Coupon

# SEND NO MONEY

Order whatever or as many as you want. For your convenience use the coupon. When the postman delivers your order you pay him for whatever you have ordered, plus a few cents postage.

Immediate Shipment Guaranteed

PRESS GUILD, Inc. RLG 12-28  
 16-18-G—East 30th St., New York.  
 Please mail me at once as many of the following items as I have indicated.  
 .....Skinderviken Transmitter Units at 95c. for 1; \$1.75 for 2; \$2.50 for 3;  
 .....\$3.20 for 4.  
 .....P. G. Microphone Transformers at \$2  
 When delivered I will pay the postman the cost of the items specified plus postage.  
 Name .....  
 Address .....  
 City ..... State .....

# A Small Part with a BIG JOB

AMPERITES take little space, but they control the very life blood of your receiver by automatically regulating the tube filaments.

It pays to use AMPERITE—the only self-adjusting resistance for "A" current. Maintains filament temperature at proper voltage despite variations in supply. Essential with eliminators. Entirely unlike fixed resistors. Instantly interchangeable. Banishes hand-rheostats. Beautifies panel layout. Saves wiring. A type for every tube—battery or A. C. \$1.10 with mounting (in U.S. A.), at all dealers.

**Radiall Company**  
50 FRANKLIN ST., NEW YORK



FREE  
"Amperite Blue Book" of new circuits and how-to-build data—Write Dept. RL4

## AMPERITE

The "SELF-ADJUSTING" Rheostat

### Before Buying

#### Any "A" Eliminators

Write me about the discount card which enables you to purchase the new and improved

#### Knapp "A" Power Kit

at a liberal discount.

The most complete "A" Power Kit ever offered—Address for details of plan—

David W. Knapp, Pres.

Division of P. R. Mallory & Co., Inc.  
Room 415, 350 Madison Ave., N. Y. C.

Send for  
**THIS BOOK**  
It Offers You Tremendous Opportunities

## BARAWIK, THE OLD RELIABLE RADIO SERVICE

Radio Fans, from "way back when," will remember the exceptional service that Barawik rendered when getting radio parts was like pulling teeth. First upon the scene, Barawik was always ready to deliver the newest developments in radio to its customers in the days when changes were fast and furious.

Today Barawik has grown to be a mighty institution in the radio world. Here you can secure the proved, reliable merchandise of the world's leading radio manufacturers—everything from complete sets to the smallest individual parts so necessary to the set builder. You can depend upon the reliability of Barawik goods. You can depend upon Barawik's ability to deliver the kind of service that means time saved in waiting. You can depend upon Barawik's honesty, ability and willingness to serve you—And, last, but far from least, you know that Barawik's big discounts assure you of the lowest prices always—prices that mean huge savings to you in everything you buy.

The newest in radio sets, parts, kits, supplies— all under one roof—ready for you now. Send coupon now for big new Catalog—Free.

**BARAWIK CO.**  
412L Canal Sta.,  
CHICAGO,  
U. S. A.

Mail this Coupon Now for Barawik's Big Free Bargain Book.  
Name..... Address..... City.....

the builder desire the amplifier to operate into a dynamic type speaker then it becomes necessary to use a type 200 Amertran output transformer.

Glancing at the wiring diagram one will learn that the circuits proper are fairly simple, and if followed out the general assembly and wiring should present little difficulty.

## The Thordarson Two-Stage Phonograph Amplifier

(Continued from page 71)

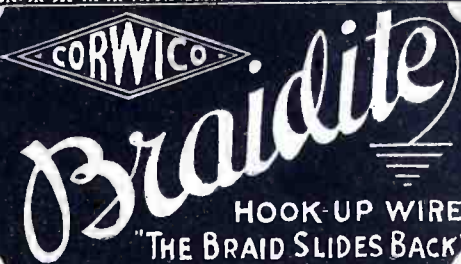
199 tube forms a part of the divider circuit. When the 100 volt field of the dynamic speaker is connected to the terminals marked "Field," about 60 millamperes will flow through the field windings of the dynamic speaker and will be available for heating the filament of the 199 tube.

A technical description of this unit comprises the following data. The size of the amplifier is 10"x10". The plate voltage applied to the plate of the 210 power tube is 385 volts, secured through the voltage drop of the 5,000 ohm resistor and the field of the dynamic speaker. The grid bias of 25 volts is secured through the voltage drop through the filament of the 199 tube and the 400 ohm potentiometer. The plate potential for the 199 tube is taken from the high voltage side of the power field of the dynamic speaker about 125 volts. The grid bias for the 199 tube is obtained from the voltage drop between the filament side of the 400 ohm potentiometer and the movable arm. The arm should be adjusted for best results. The undistorted output of the 210 power tube operating under the above conditions is about 1,200 milliwatts.

In view of the fact that dynamic speakers have incorporated in their assembly an output transformer, none is needed in the amplifier itself. It is to be noted at this point that the type of dynamic speaker used must be of the high voltage field type.

If for any reason it is desired to use this amplifier with other than the dynamic speaker it will be necessary to use an output transformer, for the current output of the 210 tube is apt to burn out the fine wire windings of the speaker. The primary of this transformer should be connected to the two terminals marked "speaker" and the loud speaker should be connected directly to the secondary of this transformer. It will also be necessary to compensate for the field current of the dynamic speaker. This may be done easily by inserting a 2,500 ohm resistor in place of the field, that is, connect the resistor to the two terminals marked "Field."

This amplifier is extremely quiet in operation, the A.C. component or 60-cycle hum being barely audible even a foot or two away from the speaker. If for any reason a hum of this nature should develop, it may be practically eliminated by grounding the amplifier. This may be accomplished by connecting from any available ground to the "Field" binding post which connects to the filament of the



HERE are the features that make Corwico Braidite Hook-Up Wire the first choice of amateurs as well as professionals.

Braidite can be easily twisted for filament leads, making it excellent for all A.C. work. It holds its shape permanently after bending. You cannot scorch or burn Braidite with a soldering iron. Being a sleeve insulated hook-up wire, Braidite is safe to work with, yet it is as convenient as bare wire. Braidite cuts wiring time in half. The insulation can be easily shoved back far enough for both solder and post connections, sliding back into place after the connection is made. Braidite thus provides a neat, clean and effective insulation for all exposed areas. It is the fastest and easiest working hook-up wire made. Use Braidite in the next set you build. Write today for a

### FREE SAMPLE



Send us the name and address of your dealer and we will send you a sample package of Braidite FREE. Include 10c for postage.

At All Dealers

25 Feet Stranded ..... 35c  
25 Feet Solid ..... 30c  
Red, Green, Yellow, Blue, Black

## CORWICO RADIO'S BEST WIRES

ANTENNA WIRES  
Stranded Braided, Solid, Plain, Tinned, Enameled

COMPLETE ANTENNA KITS  
From \$1.75 to \$4.50

HOOK-UP WIRES

"Braidite" "Flexibus," Colored Rubber  
A-C ADAPTER HARNESSSES  
Type R for RCA type tubes.....\$8.00  
Type A for ARCTURUS type tube 5.00

## CORNISH WIRE Co

30 Church Street New York City

# Latest GREATEST RADIO CATALOG and GUIDE

THE BARAWIK CO. has, all these years, been famous for its variety of radio supplies, which it offers at money-saving prices. Newest dynamic speakers, "B" eliminators, socket power equipment, A-C harness, fine cabinets and furniture, amplifiers, latest amateur equipment, tubes, batteries; in fact, anything you can ask for is here, ready to ship, at a saving in price. Quality merchandise, selected goods by reliable makers — just what you want — at big discounts.

## Your Savings are Tremendous

Ask any of the quarter million Barawik customers why they trade here, and they'll tell you that, **quality considered**, our prices can't be beat. That's something to think about! Quality comes first — new, fresh, good reliable merchandise, but the price always means a tremendous saving, nevertheless. Get our catalog and prove this to yourself. Don't spend a nickel until you see our offerings first.

You need this great radio bargain book as never before — Mail the coupon now — TODAY.



**BARAWIK CO.** 412-A Canal Sta. Chicago, U.S.A.

Mail This Coupon for FREE Bargain Book.

Name .....

Address .....

## More "A" Power For Less Money!

With the Set Builders discount card you can purchase a

### KNAPP "A" POWER KIT

at a liberal discount.

Write me today for full details telling about this new money-saving plan for set builders.

**DAVID W. KNAPP, Pres.**  
Knapp Electric, Inc.

Division of P. R. Mallory & Co., Inc.

Room 415, 350 Madison Ave., N. Y. C.

## CUSTOM SET BUILDERS

Browning-Drake has an interesting proposition. Write today for details.

Specifications for the 1929 A.C.

Shield Grid receiver will be sent on request.

**BROWNING-DRAKE CORP.**  
Cambridge, Mass.



**SHANCO** Grip-Tite Battery Clips give better contact, more powerful tension, longer life. Four sizes to meet every demand. No springs to heat up or burn out. Approved by Radio News Laboratory. Big value and permanent investment. Write Dept. 53 for details.  
SHANKLIN MFG CO., Springfield, Ill.

## SET BUILDERS

Elections have brought back Custom Set building. Business is booming. Thousands of old-timers are cleaning up. Let Barawik show you the way to bigger profits, more sales. Send today for Barawik's Big Bargain Book — the radio man's bible.

**BARAWIK CO.** 412-A Canal Sta. CHICAGO, U. S. A.

Mail This Coupon Now for Free Radio Guide

Name .....

Address .....

199 tube. It is also advisable, in some instances to ground the pick-up by connecting one of the "Input" terminals to ground. Just which terminal is to be used for this purpose must be determined by trial.

It will be well for the constructor to follow the arrangement of apparatus as shown in the illustrations as the several transformers have been placed so as to have a minimum of coupling between the power transformer and the audio units.

This amplifier is not designed for use with radio receivers as no provision has been made for supplying current for plate or filament of any other tubes than those incorporated in the unit itself. If used with a receiver, it will be necessary to obtain "B" supply for the balance of the receiver from another source.

## An Amplifier and Power Supply for Television Reception

(Continued from page 95)

put voltage produced at the plate of the preceding tube, within certain limits. The maximum A.C. voltage produced in the plate circuit of the detector tube should not exceed .5 of one volt, otherwise distortion will be encountered through the entire amplifying system.

In the operation of the amplifier it is desirable to have facilities for plugging in on the plate circuit of each tube to check whether there is any tendency for the plate current to swing. Where the plate current of the first amplifier tube shows any tendency to variation, then the voltage at the input side of the detector tube should be cut down. Resistors for use in an amplifier of this description should be free from any effective shunting capacity in excess of a few micro-micro-farads. The kino-lamp in the plate circuit of the 371 tube is the means by which the light impressions are produced to form the image at the receiving end. The light variation output of the kino-lamp is scanned in the same manner as the subject at the transmitting end.

In radio-vision reception it is desirable to use "C" batteries to obtain the necessary grid bias on all but the last tube. The "C" bias can of course be obtained from the "B" supply, though this practice is not recommended in its present form. The radio frequency tubes may of course be biased through the drop across a resistance either in the filament circuit when the tube filaments are heated from a storage battery, or bias may be obtained from the "B" supply. An "A" eliminator should not be used to heat the filaments on the audio or detector tubes as a ripple of the order of a few micro-volts will go a long way to providing discouraging results. There is no doubt that an "A" eliminator could be used where the out-

# ANATOMICAL MANIKINS MALE AND FEMALE



This is a pre-publication offer to the readers of Radio Listeners' Guide and Call Book. "Anatomical Manikins," a most valuable book containing twelve true-to-life color plates (6" by 14") of the various systems of the human body together with a large number of black and white drawings, is offered to our readers at a tremendous saving price.

This new book edited by Dr. David H. Keller, M.D., shows the human body with each aspect of its structure in separate sections. The exact positions of all organs, of every vein, artery, nerve, muscle, bone, etc., all in actual, natural colors. Opposite each plate Dr. Keller has written a page of explanatory text, profusely illustrated with photographs and drawings of the various parts of the human body.

"ANATOMICAL MANIKINS" is especially recommended for the use of medical students, nurses, art students, lawyers for use in litigation, lecturers, physical culturists, hospitals, sanitariums, schools, colleges, gymnasiums, life insurance companies, employees health departments, and for every layman.

It is of inestimable value to the prospective mother, because of the information it provides on the essential anatomical facts of pregnancy. Of great importance also are the complete color plates of the male and female internal and external sexual organs. These drawings are actual, true-to-life detail illustrations, highly important for every man and woman.

Books of this kind when bought through regular medical supply channels, cost from \$15 to \$25 a copy. Our book, equally valuable with 12 large plates of the human body—in full color, each with an accompanying page of text can be bought before publication for the low price of

**\$1.00**

THE COPY

Add ten cents for postage in U. S. and twenty cents in foreign countries.

### IMPORTANT

THIS IS A PRE-PUBLICATION OFFER. THE BOOK WHEN ACTUALLY ISSUED WILL COST FROM \$2 TO \$3 A COPY. Take advantage of this opportunity for advance subscription. Order now. Save more than one-half of the standard price to be charged later.

**CONSRAD CO., Inc., 230 Fifth Ave., N. Y.**

Consrad Co., Inc., 230 Fifth Ave., New York.

Gentlemen:  
I wish to take advantage of the special pre-publication offer for ANATOMICAL MANIKINS. Enclosed find one dollar (add ten cents postage in U. S., twenty cents in foreign countries), in full payment. I understand that ANATOMICAL MANIKINS will not be on sale until January, 1929, and that my order will be filled in the rotation in which it is received.

Name .....

Address .....

City ..... State .....



**Behind the POLYMET**  
Trade Mark



**T**HE natives of an obscure Scottish isle specialize in weaving the finest of woolsens. Shipments can be made only when a chance vessel calls. **QUALITY?** Yes, but delivery lacks dependability.

A one-time manufacturer of very fine automobiles is no longer in business. Again **QUALITY**, but owners lack service.

Behind the Polymet seal there is unquestioned **QUALITY**, and something more—the Polymet organization, insuring the utmost in **SERVICE** and **DEPENDABILITY**.

Send for the Polymet Catalogue

**POLYMET MANUFACTURING CORPORATION**

607 Broadway, New York City

**POLYMET PRODUCTS**

**Write for this Discount Card NOW!**

*It will enable you to purchase the New and Improved*

**KNAPP "A" POWER KIT**  
at a liberal discount

The new Knapp "A" is the finest and most complete kit ever offered. It is the only "A" Power adaptable to Short Wave—Super Heterodyne and Television reception.

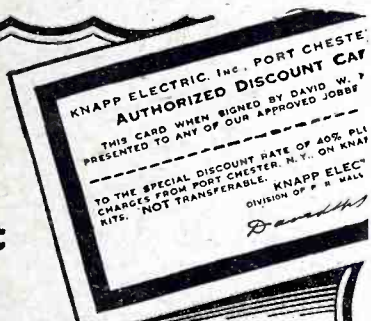
Take advantage of the wonderful offer today—write

David W. Knapp, Pres.

**Knapp Electric, Inc.**

Division of P. R. Mallory & Co., Inc.

Room 415, 350 Madison Ave., N. Y. C.



put filter in as efficient as the "B" supply, which is shown in the accompanying diagram. Such a method of filtering is impracticable due to high cost of chokes for such a system. Each individual voltage at the output of the eliminator must be heavily by-passed by fairly large filter condensers. In this measure it might be said that some experimenting might be necessary to secure a suitable combination to make a satisfactory filter network. The use of a rectified alternating current supply as plate potential considerably modifies the frequency characteristic which is obtained under measurement when the amplifier is operated purely from dry or storage batteries and the extra filtering in each "B" circuit is necessary to correct this.

The resistance coupled amplifier should preferably be kept away from the power supply transformer, since it has been found that the amplifier itself tends to pick up the high voltage noises emanating from the power transformer. The leads from the power supply which carry any alternating current might well be shielded by means of a heavy copper braid or B.X. cable which should be grounded. The negative "B" of the amplifier should also be grounded. In this respect the use of the electric light mains as a ground should be avoided. A ground which is actually at the ground potential should be used. A water pipe is perhaps the best obtainable in the home.

It will be noticed that a 210 type of power compact is used to operate the 171 tube. This is desirable in view of the additional filtering involved in the circuit. This filtering causes an extra voltage drop in excess of that which would be encountered were the 210 type compact being used for its orthodox purpose.

The same amplifier can of course be used for radio reception and in such capacity will produce tonal quality of an incomparable degree. A key can be used in the plate circuit of a 371 tube to alternatively switch from a loud speaker to the kino-lamp, which should have a resistor of approximately 2000 ohms in series with it, to restrict the current flow from the lamp to approximately 20 milliamperes.

It is of course necessary to employ a similar method of scanning the output of the neon lamp as is employed at the transmitting end. The disc must have the same number of holes and must be revolved at exactly the same speed and in step.

Where reception of radio-vision signals is to be made within reasonably short distances of the transmitter, that is where the same alternating current power supply is available at both the transmitting and receiving stations, synchronous motors can be used satisfactorily to keep the sending and receiving scanning apparatus in synchronism. If the transmitting and receiving equipment be widely separated, even though they are on the same power line, some difficulty is liable to arise in synchronizing due to phase shift, which will be more pronounced in certain districts than in others. However, taking all things into consideration, the use of synchronous motors seems to be about the cheapest means of solving a very necessary problem.

**RADIO'S HALLMARK OF QUALITY**  
**DeJUR-AMSCO**  
WORLD'S LARGEST MANUFACTURER OF HIGH GRADE RADIO PARTS

The DeJur-Amsco line of quality radio parts is the most complete and diversified in the industry. Whenever you need anything from the smallest part to the largest unit in a receiver, go to your dealer and ask him to show you the DeJur-Amsco line.

We are the world's largest and oldest manufacturers of high grade radio parts. Our long experience assures the highest quality and our larger output and most modern manufacturing facilities assure the lowest prices consistent with quality.

**Some DeJur-Amsco Products**

- Rheostats
- Condensers
- Resistors
- Choke Coils
- Speaker Filters
- R.F. Coils
- Three Circuit Tuners
- Sockets
- Molded Mica Condensers
- Phone Plugs
- Pin Jacks
- Grid Leaks
- Resistor Mountings
- Voltage Regulators
- Voltmeters

*Write for Catalog*

*Write today for DeJur Catalog No. 28 illustrating, describing and pricing every item in the DeJur-Amsco line.*

**DeJUR-AMSCO CORPORATION**

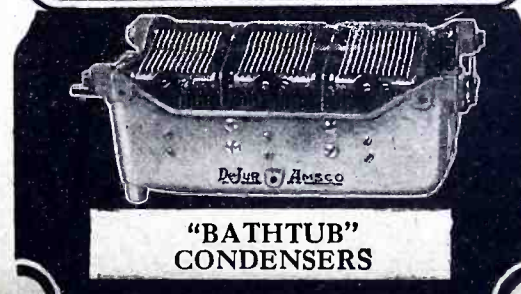
Broome and Lafayette Streets

**NEW YORK CITY**

**DE JUR-AMSCO**

**"BATHTUB" CONDENSERS**

These new type Bathtub Condensers are the most perfect units made for single-control tuning. They are available in double, triple and quadruple combinations in all capacities.



**"BATHTUB" CONDENSERS**

**BIGGER Radio Guide**

**LATEST RADIO GUIDE**  
Keep pace with radio's newest ideas—A-C, grid tube, dynamos, television, scores of new developments. Since radio's dawn Barawik has kept ahead by bigger stocks, better service, lowest prices. Barawik's Big New Radio Guide is now ready—send for it.  
Wholesale discounts to set builders, dealers and agents.

**FREE** BARAWIK CO.  
412R Canal Sta., Chicago, U.S.A.

Mail This Coupon Now for Free Radio Guide

Name .....

Address .....

# W.C. BRAUN COMPANY

## WHOLESALE RADIO HEADQUARTERS

### Radio Is Booming

**T**HIS is the peak year in radio. Business is booming. The public realizes that A.C. sets and tubes are here, and perfected. Those who are now in the radio business are thriving because they're giving the public what it wants—real entertainment at a low cost.

Whether you are a dealer selling complete factory-built radio sets or a professional set-builder building custom-built radio, W. C. Braun Company, Wholesale Radio Headquarters, offers you the choicest products of the world's leading manufacturers at prices that will appeal to the public and create more sales and profits for you.

### See Our Permanent Radio Show

In our commodious display rooms we conduct a permanent radio show for the benefit of visiting dealers. Here are on display and for demonstration purposes the latest designs in radio sets, fine radio furniture, latest speakers and built-up models for the leading custom-built circuits. You are invited to come in and inspect this merchandise, to try it out, to convince yourself that it is what you can recommend and sell to your trade.

### The World's Largest Mail Order Radio Store

Here, under one roof, is carried the world's largest stock of radio sets, circuits, furniture, speakers, accessories and parts. Besides a complete radio line, we have a full line of auto supplies, tires and tubes, electrical supplies, camp fixtures, wiring material, sporting goods, holiday merchandise; in fact, the very things that help you to do a profitable all-year-round business. Mail orders are given special attention, our same-day service meeting the requirements of dealers the country over.

### Have You the Big Braun Radio Catalog?

Braun's Dealers' Buyers' Guide and Catalog shows 264 pages crammed full with bargains. This catalog is sent free to dealers. If you haven't received your copy, be sure to write for it.

**W. C. Braun Company**  
598-B Randolph St.

**CHICAGO**  
ILLINOIS



### Distributors of These Nationally Known Radio Lines

All-American	Balkite	Hammarlund-
Aero	Micamold	Roberts
Jewel	Baldwin	Steinite
Amsco	Thordarson	De Jur
Pacent	Trimm	Jones
Bremer-Tully	Excello	Magnavox
Silver-Marshall	Samson	Jensen
Raytheon	Carter	Temple
Browning-Drake	Polymet	Farrand
Kingston	Pilot	R.F.I.
Belden	Cardwell	Potter
Cockaday	Mathieson	Peerless
Lynch	McCullough	Newcomb-
Bosch	Aalco	Hawley
Scott	Burgess	Superior
Pioneer	Bodine	Lund
Hammarlund	Remler	Pierson
Karas	Hoyt	Showers
Daven	Acme	Amplion
Valley	Continental	Pathe
Benjamin	Allen-Bradley	Aerovox
Jefferson	Victoreen	Parvolt
Amertran	Signal	Amperite
General	Ultradync	Arcturus
Sangamo	Stevens	Cornish
Dubilier	Madison-Moore	Utah
Eveready	Precise	United-Roberts
Sterling	Eagle	Hyatt
Standard	National	Dongan
Bruno	H.F.L.	Ceco
Sonatron	Eby	Abox
Magnaformer	Tyrman	Elkon
Cunningham	X-L	Racon
R.C.A. Tubes	Cutler-Hammer	Readrite
Monroe Sets	Frost	B.M.S.
Elkay	Durham	Cardwell
Kurz-Kasch	Yaxley	R.E.L.
Trav-Ler	Muter	Ward-Leonard
Centralab	Conrad	Electrad
Marco	Na-Ald	Goodell-Pratt
Kodel		And many others



FACTORY TO YOU—SAVE 50%—COMPARE WITH COSTLIEST OUTFITS BEFORE YOU BUY

# Enjoy a powerful new Miraco <sup>set or complete outfit</sup> 30 DAYS FREE

AC Electric or Battery

**3 Year Guarantee**

**Get Our Send No Money 9th Anniversary Offer!**



**Built like, Looks like, Performs like a \$200 set**

Marvelous new 3-year guaranteed, lighted 1-dial control. All metal Super Shielded Miraco set, removed from cabinet. Front switch, phonograph pick-up connection and all latest features. Built in power section on AC models.

**The Latest, Finest and Costliest Construction**

**\$49<sup>88</sup>**  
COMPLETELY ASSEMBLED

**NEW LOW FACTORY PRICES SAVE 50%**

**Wide Selection of Beautiful Cabinets AC or Battery Sets**

**30 DAYS HOME TRIAL**



A popular walnut Hi-Boy Console, with drop-leaf desk. Beautiful two-tone finish. Rare bargain!

Richly designed, genuine walnut console of finest type. Electro-dynamic or magnetic power cone, or long air column speaker. Marvelous value.



Beautifully graceful Spinet console, genuine two-tonewalnut. Choice of speakers. Also comes in Electric Phonograph-Radio Combination.



A new-type arm-chair console. Genuine walnut. Very pretty. Low priced. Electro-Dynamic or Magnetic-Power Speakers.



At right, a Lo-Boy console, walnut finish, that costs little. A gem!



Above, popular inexpensive combination. Set on Table Speaker (sold separately).



Metal or wood compact style cabinets. Wood cabinets in walnut or new shaded silver-chrome finishes. Cathedral Electro-Dynamic or Magnetic-Power Speaker to match!

**8 tube ~ one dial** Electric Lighted

# MIRACO

TRADE MARK REGISTERED

**CATHEDRAL TONED, SUPER SELECTIVE, POWERFUL DISTANCE GETTERS**

Celebrating its 9th successful year, America's big, old, reliable Radio Corporation springs a genuine sensation in high-grade sets. With its latest, Super-powered, 1-dial Miracos—the All Electric wholly self-contained, hum-free, AC-8 and AC-9, using AC tubes or the new 8-tube models for batteries or Eliminators—you are guaranteed values and savings unsurpassed in the fine set field.

Compare a Miraco with highest-priced radios, for 30 days in your home. Surprise and entertain your friends—get their opinions. Unless 100% delighted, *don't buy it!* Return everything—the complete outfit—at our expense. Your decision is final—absolutely!

Only exceptionally fine radios, of the very latest approved type, at rock-bottom prices, could possibly back up so liberally unconditional a guarantee. Send coupon now for *Amazing Special Factory Offer!*

**Don't Confuse with Cheap Radios** With its rich, clear Cathedral tone,

**Miraco Outperforms 'em All in Chicago** On the Miraco Unitune, to start with, will say: I got to date 61 stations outside of Chicago, from the Pacific Ocean to the Atlantic Ocean, and from Anchorage, Alaska, to the Gulf of Mexico, and I tried the set with 3 different antennas. That is an outside aerial 152 feet, an inside aerial 20 feet, and

hum-free operation, tremendous "kick" on distant stations and razor-edge selectivity—with its costly sturdy construction, latest features, including phonograph pick-up connection, ease of tuning, beauty, and economy—a Miraco will make you the envy of many whose radios cost 2 to 3 times as much!

Many thousands of Miracos—bought after 30 day home comparisons—are cutting through locals and getting coast to coast with the tone and power of costly sets, their delighted users report. Miracos are laboratory-built with finest parts, and embody 9 years' actual experience in constructing fine sets. Approved by Radio's highest authorities.

**Deal Direct with Big Factory**

Everything reaches you splendidly packed and rigidly tested to insure your instant enthusiasm. Enjoy the outfit 30 days—then decide. Liberal 3-year guarantee on each set. Play safe, save lots of money, and insure satisfaction by dealing direct with Radio's old, reliable builders of fine sets—9th successful year.

light socket. I want to say that your set does outperform the other sets I have. I put it up against a World Record Super 9 and beat that one. Then I put it up against a (names expensive make), and beat that one. Next I put it up against a Neutrodyne and beat that one. HARRY KOPP, 6555 South Peoria Street, Chicago, Illinois.

**MIDWEST RADIO CORPORATION, 566-RD Miraco Building, Cincinnati, Ohio**

**BEAUTIFULLY ILLUSTRATED CATALOG, AMAZING SPECIAL FACTORY OFFER, TESTIMONY OF NEARBY USERS**—All the proof you want—of our honesty, fairness, size, financial integrity, radio experience and the performance of our sets—including Amazing Factory Offer—sent with catalog.

Dealers Write!



**Free!**

**MIDWEST RADIO CORPORATION**  
Pioneer Builders of Sets—9th Successful Year  
566-RD Miraco Bldg., Cincinnati, Ohio

**THIS COUPON IS NOT AN ORDER**

WITHOUT OBLIGATION, send free catalog, Amazing Special Factory Offer, testimony of nearby users, etc.  User  Agent  Dealer  
 Check here if interested in an **EXCLUSIVE TERRITORY PROPOSITION**  
NAME ADDRESS



**AC-8—\$71.50**

Unbeatable value in a 3-year guaranteed Super Shielded Metal Chassis.



**Also New, More Powerful Battery Sets**

The newest and latest in battery operated sets, designed with same advanced features used in electric sets! Same wide choice of cabinets. Highest quality, amazingly low priced!

Ready for you now ~

# SCOTT'S World's Record SHIELD GRID NINE All Electric!

**H**ERE it is! The World's Record Scott *Electrified!* The finest of laboratory Shield Grid models, available now for A.C. light socket operation.

Thousands have asked us for an A.C. Electric set offering all the superb qualities of the famous Scott battery-operated set that established four authoritative world's DX records. We were not ready to offer A.C. operation until we had made several important improvements, including a newly developed "A" Eliminator, that would insure A.C. reception as good and better than with battery power.

## Unlimited Range with Superb Tone and Volume

Now we are ready to announce the ultimate in A.C. radio reception—this wonderful new A.C. World's Record Shield Grid Nine! Fully electrified—and affording all the convenience of light socket operation. No batteries to worry about; no chargers of any sort. Just plug into your A.C. light socket, and listen to a revelation of all-electric radio reception such as you have never heard before.

Rangeless distance—volume—tone—selectivity—all are yours, to a degree of flawless perfection that astounds even in this day of enormously improved radio.

## Build in Four Hours Results Guaranteed

There are no tricky adjustments to this A.C. set. You can build it in four hours, easily. Simply wire it up—plug in—and you have your receiver operating at maximum efficiency. Shielded grid amplifier unit comes fully tested and wired. Transformers are perfectly matched, with no exterior adjustments to make. Every part of this remarkable A.C. receiver is designed especially for this set, including the new perfected "A" Eliminator, and all are matched with laboratory precision.

*We guarantee that you can build the New Scott Nine and get the same results we obtain from our Laboratory models.*

## Amazing Output Insures Extreme Selectivity

The tuned R.F. and Shield Grid Long Wave R.F. of the Scott Nine give truly amazing results. The tremendous output of this set is much greater than that of the average good "super." As a result, extreme selectivity is always

obtainable. Not "fussy," uncertain selectivity; but razor-sharp sensitivity, obtainable in a stable circuit condition with tubes operating at normal voltage.

## Low Cost Operation

The New Scott A.C. Shield Grid Nine combines tremendous power with unusual operating economy. The eight tubes incorporated in the receiver draw only 29 mils. Maximum volume is obtained by the use of the Scott Power Pack and Amplifier, incorporating the ninth tube for the second stage of audio. The latest 250 power tube is used, providing tremendous power with perfect tone quality.

## SET BUILDERS! Sell in a protected market

To build up a permanent, prosperous business, you must have the kind of support that Scott gives you. You can't afford to spend time, effort and ability building up a demand in your community only to have it supplied through "net-price" catalogs.

Get behind this fine receiver. It sells on demonstration. We help you secure and bring in prospects through our elaborate sales plan, including mailing folders, with your name imprinted, valuable Sales Manual and other selling helps. Tie up with this money-making plan. Make each day build for the future—the day when you will have a real, profitable business. Write for particulars today.

## FREE! PLANS!

Write at once for free circuit diagrams and full particulars about the Scott A.C. Shield Grid Nine. Also copies of authoritative 6000 and 9000 mile reception tests. Get all the amazing facts about this World's Record Set. Also particulars about battery-operated set. Mail coupon below.



**SCOTT TRANSFORMER CO., 4448 Ravenswood Ave., CHICAGO**  
**Clip this Coupon for particulars**

Send full particulars about the Scott World's Record Shield Grid Nine, including Free Circuit Diagram, world's record test verifications, etc.

- A.C. Model
- Battery operated Model

Send also particulars about your special proposition to professional set builders.

Name ..... Town .....

Street ..... State .....

RLCB-12

**SCOTT TRANSFORMER CO.**  
 4448 Ravenswood Ave.  
 Chicago, Ill.